



**Pool Care Thailand**

**PRICE LIST  
2023**



poolcaethailand



poolcaethailand



asiapoolcare@gmail.com



# SERVICE

เรามีทีมให้คำปรึกษาพร้อมสระตัวอย่างให้ทดลองใช้  
และสัมผัสประสบการณ์จริง



**ออกแบบ**  
สระว่ายน้ำ ออกแบบโครงสร้าง  
ออกแบบงานระบบ



**โครงสร้าง**  
โครงสร้างสระว่ายน้ำ สระสปา  
สระโซลต์ต่าง ๆ



**การวางระบบและติดตั้ง**  
ห้องเครื่อง / ระบบท่อ / ระบบกรอง /  
ระบบฆ่าเชื้อโรค / ระบบไฟใต้น้ำ



**การบำรุงรักษา**  
ปรับปรุงสระ / ระบบ  
ดูแลสระรายเดือน-รายปี / ซ่อมบำรุง



**ปรึกษา**  
ให้คำปรึกษางานก่อสร้าง งานวางระบบ  
รูปแบบสระ คุณภาพน้ำ การใช้สารเคมี

# RESOURCE CENTER



# CONTENTS

<b>POOL CHEMICALS</b> .....	<b>7</b>	<b>POOL &amp; SPA FITTINGS</b> .....	<b>198</b>
Chlorine .....	8	Gratings .....	200
Algaecides .....	12	S.S Ladders .....	202
Others .....	16	Surface Skimmers .....	207
<b>COMPLETE SET SWIMMING POOL</b> .....	<b>19</b>	Pool Fittings.....	210
Swimspa .....	20	Spa Fittings.....	219
<b>FILTERS</b> .....	<b>22</b>	Air Switches.....	226
Pool Filters .....	23	<b>UW SPEAKERS</b> .....	<b>228</b>
Koi Fish Filters .....	42	<b>SAFETY SYSTEM</b> .....	<b>230</b>
Multiport Valves .....	47	<b>VALVES</b> .....	<b>232</b>
Filter Media.....	55	<b>INSTALLATION EQUIPMENTS</b> .....	<b>240</b>
<b>FILTRATION SYSTEMS</b> .....	<b>58</b>	<b>ROBOT POOL CLEANERS</b> .....	<b>242</b>
<b>PUMPS</b> .....	<b>67</b>	<b>MAINTENANCE KITS</b> .....	<b>249</b>
<b>DISINFECTION SYSTEMS</b> .....	<b>100</b>	<b>STEAM GENERATORS</b> .....	<b>255</b>
Fresh Water System .....	102	<b>SUANA HEATERS &amp; ROOMS</b> .....	<b>263</b>
Salt Chlorinators .....	106	<b>AQUA FITNESS</b> .....	<b>278</b>
UV-C Systems .....	116	<b>POOL SURROUNDING &amp; COVER</b> .....	<b>285</b>
Chlorine Feeders .....	122	Ledge Lounger Furniture .....	286
Chemical Controllers .....	124	Pool Cover.....	298
<b>UNDERWATER LIGHTS</b> .....	<b>127</b>	<b>WARRANTY</b> .....	<b>299</b>
Pool Lights.....	128	<b>TIPS</b> .....	<b>312</b>
Fountain Lights .....	148	<b>CONTACT US</b> .....	<b>328</b>
Control & Remote.....	150		
UW Accessories .....	152		
<b>COMPETITION EQUIPMENTS</b> .....	<b>154</b>		
<b>WATER FEATURES</b> .....	<b>160</b>		
<b>SWIM JET SYSTEMS</b> .....	<b>180</b>		
<b>HEATING SYSTEMS</b> .....	<b>189</b>		

# POOL CHEMICALS





# “NISSAN” T.C.C.A 90 Chlorine Made In Japan

**INSTRUCTION OF POOL MAINTENANCE**

**Dosage** 3g / 1 m<sup>3</sup> water / day  
(Turnover cycle at 8 hours)  
**Pool Size :** Depth 1.50 meters / Length 20 meters /  
 With 10 meters  
 300 m<sup>3</sup> (1.5 x 20 x 10)  
**Water Volume :** 3g (T.C.C.A. 90 / day) x 300 m<sup>3</sup>  
**Calculation :** = 900g (T.C.C.A. 90 / day)

**RAPID REMEDY OF SHORTAGE**

Add the product to adjust level to the target value,  
 this reference may change depend on the water condition.

**GENERAL MAINTENANCE**

Regular measurement of Chlorine, pH and Total Alkalinity is important  
**Chlorine :** 1.0 to 1.5 ppm  
**pH :** 7.2 to 7.6  
**Total Alkalinity :** 50 to 100 ppm

**STORAGE & HANDLING**

- Do not mix with other chemicals
- Store under cool dry condition and away from water, moisture, any easily oxidizable matters and sources of heat.
- No sweeping or waste should be out into bins, as accidental contamination with easily oxidizable matter could fire
- Damp or contaminated material should never be repacked in containers

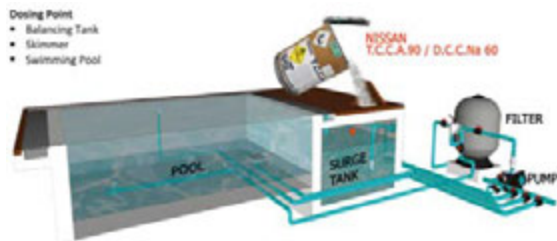

Chemical	T.C.C.A. 90	Pool Volume (m <sup>3</sup> )	NISSAN T.C.C.A. 90 (grams / day)
Chemical formula	C <sub>2</sub> N <sub>2</sub> O <sub>2</sub> (Cl) <sub>3</sub> (Organic)	50	150
Appearance	Solid	100	300
pH	Acidic	200	600
Available Chlorine	90%	300	900
Residue in water	none	400	1,200
Stability of residual chlorine	Long	500	1,500
Dosage / Day / 8hours running at Pool capacity 300m <sup>3</sup>	0.9 kg	700	2,100
Storage stability	3 years or more	1,000	3,000

**T.C.C.A 90 (Trichloroisocyanuric Acid) Granular & Powder Types**

Code	Model	Type	Packing (Kg/Drum)	Retail Price	Code✖
14001400045	CL-NS-90-G-50	Granular	Fibre Drum	6,9000.00	Y
14001400050	CL-NS-90-P-50	Powder	50 kgs	6,9000.00	
14001400025	CL-NS-90-G-20	Granular	20 kgs	3,260.00	Y
14001400030	CL-NS-90-P-20	Powder		3,260.00	
14001400010	CL-NS-90-G-7	Granular	7 kgs	1,270.00	Y
14001400015	CL-NS-90-P-7	Powder		1,270.00	
14001400065	CL-NS-90-G-1	Granular	1 kg	280.00	Y
14001400000	CL-NS-90-P-1	Powder		280.00	



หมายเหตุ : ราคายังไม่รวมภาษี 7% บริษัทฯ ขอสงวนสิทธิ์ในการเปลี่ยนแปลงราคาโดยไม่ต้องแจ้งให้ทราบล่วงหน้า

Remarks : Excluded VAT 7%. The Company reserves the right to change the prices without announcement.



# “NISSAN” D.C.C.Na 60 Chlorine Made In Japan

### INSTRUCTION OF POOL MAINTENANCE

**Dosage** 4g / 1 m<sup>3</sup> water / day  
(Turnover cycle at 8 hours)

**Pool Size :** Depth 1.50 meters / Length 20 meters / Width 10 meters  
300 m<sup>3</sup> (1.5 x 20 x 10)

**Water Volume :** 4g (D.C.C.Na 60 / day) x 300 m<sup>3</sup>

**Calculation :** = 1,700g (D.C.C.Na 60 / day)

### RAPID REMEDY OF SHORTAGE

Add the product to adjust level to the target value,  
this reference may change depend on the water condition.

### GENERAL MAINTENANCE

Regular measurement of Chlorine, pH and Total Alkalinity is important

Chlorine : 1.0 to 1.5 ppm

pH : 7.2 to 7.6

Total Alkalinity : 50 to 100 ppm

### STORAGE & HANDLING

- Do not mix with other chemicals
- Store under cool dry condition and away from water, moisture, any easily oxidizable matters and sources of heat.
- No sweeping or waste should be out into bins, as accidental contamination with easily oxidizable matter could fire
- Damp or contaminated material should never be repacked in containers

### D.C.C.NA 60 (Sodium Dichloroisocyanurate) Granular Types

Code	Model	Type	Packing (kg/drum)	Retail Price	Code✕
14001400060	CL-NS-60-G-50	Granular	Fibre Drum 50 kgs	6,900.00	Y



Code	Model	Type	Packing (kg/drum)	Retail Price	Code✕
14001400020	CL-NS-60-G-7	Granular	7 kgs	1,270.00	Y



Chemical	D.C.C.Na. 60
Chemical formula	C <sub>3</sub> N <sub>3</sub> O <sub>3</sub> (Cl) <sub>3</sub> (Organic)
Appearance	Solid
pH	Acidic
Available Chlorine	62%
Residue in water	none
Stability of residual chlorine	Long
Dosage / Day / 8hours running at Pool capacity 300m <sup>3</sup>	1.2 kg
Storage stability	3 years or more

Pool Volume (m <sup>3</sup> )	NISSAN D.C.C.Na. 60 (grams / day)
50	200
100	400
200	800
300	1,200
400	1,600
500	2,000
700	2,800
1,000	4,000

หมายเหตุ : ราคายังไม่รวมภาษี 7% บริษัทฯ ขอสงวนสิทธิ์ในการเปลี่ยนแปลงราคาโดยไม่ต้องแจ้งให้ทราบล่วงหน้า  
Remarks : Excluded VAT 7%. The Company reserves the right to change the prices without announcement.



# POOLCHLOR

## “POOLCHLOR” T.C.C.A 90 Chlorine (G & P)

### Granular & Powder



Pool Volume (M <sup>3</sup> )	POOLCHLOR T.C.C.A. 90 (grams/day)
50	150
100	350
200	600
300	1,100
400	1,300
500	1,700
700	2,300
1,000	3,300

Code	Model	Type	Packing (kg/drum)	Retail Price	Code✕
14001620045	CL-PC-90-G-50	Granular	50 kgs	4,900.00	Y
14001620050	CL-PC-90-P-50	Powder		4,900.00	



Code	Model	Type	Packing (kg/drum)	Retail Price	Code✕
14001620030	CL-PC-90-G-20	Granular	20 kgs	2,360.00	Y
14001620035	CL-PC-90-P-20	Powder		2,360.00	



Code	Model	Type	Packing (kg/drum)	Retail Price	Code✕
14001620015	CL-PC-90-G-5	Granular	5 kgs	790.00	Y
14001620020	CL-PC-90-P-5	Powder		790.00	



Code	Model	Type	Packing (kg/drum)	Retail Price	Code✕
14001620000	CL-PC-90-G-1	Granular	1 kg	147.00	Y
14001620005	CL-PC-90-P-1	Powder		147.00	



หมายเหตุ : ราคายังไม่รวมภาษี 7% บริษัทฯ ขอสงวนสิทธิ์ในการเปลี่ยนแปลงราคาโดยไม่ต้องแจ้งให้ทราบล่วงหน้า

Remarks : Excluded VAT 7%. The Company reserves the right to change the prices without announcement.

# POOLCHLOR

## “POOLCHLOR” T.C.C.A 90 Chlorine (T)

### Tablets 200 Grams

Code	Model	Type	Packing (kg/drum)	Retail Price	Code✕
14001620055	CL-PC-90-T-50	Tablets 200 g	50 kgs	6,900.00	Y



Code	Model	Type	Packing (kg/drum)	Retail Price	Code✕
14001620040	CL-PC-90-T-20	Tablets 200 g	20 kgs	3,160.00	Y



Code	Model	Type	Packing (kg/drum)	Retail Price	Code✕
14001620025	CL-PC-90-T-5	Tablets 200 g	5 kgs	890.00	Y



Code	Model	Type	Packing (kg/drum)	Retail Price	Code✕
14001620010	CL-PC-90-T-1	Tablets 200 g	1 kg	Y	

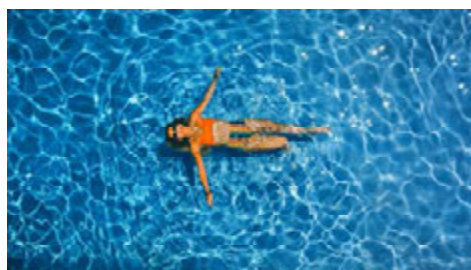

หมายเหตุ : ราคายังไม่รวมภาษี 7% บริษัทฯ ขอสงวนสิทธิ์ในการเปลี่ยนแปลงราคาโดยไม่ต้องแจ้งให้ทราบล่วงหน้า  
 Remarks : Excluded VAT 7%. The Company reserves the right to change the prices without announcement.



# Premium Algaecides (1)

## SWIMTRINE

Effectively and economically kills algae and prevents regrowth without requiring pool closure.

- Fast acting, eliminated algae within hours
- Especially effective on mustard and green algae
- Compatible with all other pool chemicals
- No waiting period – swim immediately
- East to apply
- Does not cloud water

For visible algae growth : Apply 60 cc of SWIMTRINE per 19 cu.m. of pool water

Prevention of algae : Apple 30 cc of SWIMTRINE per 19 cu.m. of pool water everyday 10-14 days



**คุณสมบัติ** ป้องกันตะไคร่น้ำสีเขียว ควรใช้เป็นประจำทุกสัปดาห์

**วิธีการใช้** ใช้เป็นประจำทุก ๆ สัปดาห์ เห็นผลเร็ว เมื่อใส่แล้วสามารถว่ายน้ำได้หลังจากเดินระบบหมุนเวียนน้ำ 1 Turnover

- อัตราส่วน**
- กรณีป้องกันตะไคร่น้ำสีเขียว 30 ซีซี ต่อ น้ำในสระ 19 ลบ.ม. (1.6 ซีซี ต่อ น้ำในสระ 1 ลบ.ม.) ใช้เป็นประจำทุก ๆ สัปดาห์
  - กรณีกำจัดตะไคร่น้ำสีเขียวที่เพิ่งเริ่มเกิดขึ้น 60 ซีซี ต่อ น้ำในสระ 19 ลบ.ม. (3.2 ซีซี ต่อ น้ำในสระ 1 ลบ.ม.)

Code	Model	Description	Packing	Retail Price	Code✕
14001610000	SwimTrine (QT)	น้ำยากำจัดไคร่น้ำสีเขียว	Quart	840.00	G ★
14001610030	SwimTrine (GL)	Algaecide Kill Green & Mustard Algae	Gallon	2,290.00	

## POOLTRINE

An algaecide water clarifier suitable for D.E Filter

- Eliminates green algae as it increases water clarity
- Two jobs done at the same time
- No waiting period – swim immediately
- Long lasting action
- Non-metallic, will not clog filters
- Non-Foaming, will not cloud water

For treatment of a freshly clean and filled pool: Apply 150 cc of POOLTRINE per 19 cu.m. of pool water everyday 7 days



**คุณสมบัติ** ป้องกันและแก้ปัญหาน้ำขุ่นเขียว ช่วยให้น้ำใสเร็วและฆ่าตะไคร่น้ำได้ในคราวเดียวกัน

**วิธีการใช้** เมื่อน้ำมีสีขุ่นเขียวเกิดขึ้น แต่มีค่า pH อยู่ระหว่าง 7.2 – 7.6 เท่านั้น หากค่า pH สูงหรือต่ำกว่าค่าที่กล่าวข้างต้นให้ปรับค่า pH ให้ได้ตามค่ามาตรฐานก่อนใช้น้ำยา เพื่อให้เห็นผลเร็ว เมื่อใส่แล้วสามารถว่ายน้ำได้หลังจากเดินระบบหมุนเวียนน้ำ 1 Turnover

- อัตราส่วน**
- กรณีป้องกันน้ำขุ่นเขียว 150 ซีซี ต่อ น้ำในสระ 19 ลบ.ม. (8 ซีซี ต่อ น้ำในสระ 1 ลบ.ม.) ทุก ๆ 7 วัน
  - กรณีเติมน้ำใหม่ 300 ซีซี ต่อ น้ำในสระ 19 ลบ.ม. (16 ซีซี ต่อ น้ำในสระ 1 ลบ.ม.) ทุก ๆ 5 วัน

Code	Model	Description	Packing	Retail Price	Code✕
14001610005	PoolTrine (QT)	น้ำยาแก้ปัญหาน้ำขุ่น/น้ำเขียวสำหรับเครื่องกรองผ้า	Quart	840.00	G ★
14001610035	PoolTrine (GL)	Algaecide & Water Clarifier Suitable for D.E. Filter	Gallon	2,290.00	

หมายเหตุ : ราคายังไม่รวมภาษี 7% บริษัทฯ ขอสงวนสิทธิ์ในการเปลี่ยนแปลงราคาโดยไม่ต้องแจ้งให้ทราบล่วงหน้า

Remarks : Excluded VAT 7%. The Company reserves the right to change the prices without announcement.



## Premium Algaecides (2)

### CLEARTRINE

Effectively and economically kills algae and prevents regrowth without requiring pool closure.

- Fast acting, eliminated algae within hours
- Especially effective on mustard and green algae
- Compatible with all other pool chemicals
- No waiting period – swim immediately
- East to apply
- Does not cloud water

For visible algae growth : Apply 60 cc of SWIMTRINE per 19 cu.m. of pool water

Prevention of algae : Apple 30 cc of SWIMTRINE per 19 cu.m. of pool water everyday 10-14 days



**คุณสมบัติ** แก้ปัญหาน้ำขุ่นมัว ขุ่นขาว เหมาะกับระบบ เครื่องกรองทราย

**วิธีการใช้** ใช้เป็นประจำทุก ๆ สัปดาห์ เมื่อใสแล้วสามารถว่ายน้ำได้หลังจากเดินระบบหมุนเวียนน้ำ 1 Turnover

- อัตราส่วน**
- กรณีน้ำขุ่นมัวมาก ๆ ให้ใช้อัตรา 60 ซีซี ต่อ น้ำในสระ 19 ลบ.ม. (3 ซีซี ต่อ น้ำ 1 ลบ.ม.) เดินบ่มน้ำ 24 ชั่วโมง จนกว่าน้ำจะใส
  - กรณีป้องกันน้ำขุ่น อัตราการใช้ 30 ซีซี ต่อ น้ำในสระ 19 ลบ.ม. (1.6 ซีซี ต่อ น้ำ 1 ลบ.ม.) ทุก ๆ 1-2 อาทิตย์

Code	Model	Description	Packing	Retail Price	Code✘
14001610010	ClearTrine (QT)	น้ำยาช่วยให้น้ำใสเร็ว สำหรับเครื่องกรองทราย	Quart	840.00	G ★
14001610040	ClearTrine (GL)	Algaecide & Water Clarifier Suitable for Sand Filter	Gallon	2,290.00	

### BLACK ALGAETRINE

The best available product for controlling black algae's innate resistance to chemical

- Insures total killing action quickly
- No waiting period for pool's use
- Excellent for cleaning algae off pool sides
- No clouding and easy to apply

Once black algae is controlled, regrowth can be effective prevent with regular use of SWIMTRINE

With Visible Algae Growth: Apply 180 cc Of BLACK ALGAETRINE per 19 cu.m. of pool water 5 days.

Settled algae debris may be removed by vacuuming.

**คุณสมบัติ** ขจัดปัญหาตะไคร่น้ำดำหรือตะไคร่น้ำที่เกาะตามยาแนว และขอบตะเข็บกระเบื้องที่มีสีเขียวคล้ำเกือบดำ

**วิธีการใช้** ใช้ติดต่อกัน 2-3 ครั้ง จนกว่าตะไคร่น้ำจะถูกกำจัดออกไปหมด โดยการใช้แปรงขัดช่วย เมื่อใสแล้วสามารถว่ายน้ำได้หลังจากเดินระบบหมุนเวียนน้ำ 1 Turnover

- อัตราส่วน**
- กรณีป้องกันตะไคร่น้ำสีดำใช้ 90 ซีซี ต่อ น้ำ 19 ลบ.ม. (5 ซีซี ต่อ น้ำ 1 ลบ.ม.) ทุก ๆ 7 วัน
  - กรณีกำจัดตะไคร่น้ำสีดำใช้ 180 ซีซี ต่อ น้ำ 19 ลบ.ม. (10 ซีซี ต่อ น้ำ 1 ลบ.ม.) ทุก ๆ 5 วัน



Code	Model	Description	Packing	Retail Price	Code✘
14001610015	Black AlgaeTrine (QT)	น้ำยากำจัดตะไคร่น้ำดำ	Quart	840.00	G ★
14001610045	Black AlgaeTrine (GL)	Algaecide Control Black & Other Resistant Forms	Gallon	2,290.00	

หมายเหตุ : ราคายังไม่รวมภาษี 7% บริษัทฯ ขอสงวนสิทธิ์ในการเปลี่ยนแปลงราคาโดยไม่ต้องแจ้งให้ทราบล่วงหน้า  
Remarks : Excluded VAT 7%. The Company reserves the right to change the prices without announcement.



## Premium Algaecides (3)

### STAINTRINE

Stain & scale preventer and remover

- Prevents staining and scaling of pool surface and components by chelating minerals such as iron, calcium and manganese
- Cost-effective & easy removal of frets stains
- Protects pumps, filters and pool heater exchange elements

New pool filling : Apply 225 cc of STAINTRINE per 19 cu.m of pool water and run filter 24 hours before adjust free chlorine to 1.5 ppm and pH 7.6-7.6

**คุณสมบัติ** ป้องกันสารสนิม และตะกรันในน้ำ ช่วยให้น้ำใสเร็วขึ้น น้ำดิบบางพื้นที่มีแร่ธาตุในน้ำสูง เมื่อเติมคลอรีนลงไปจะทำให้เกิดสนิม และ ตะกรัน ซึ่งจะยากต่อการกำจัดและทำให้น้ำใส  
**วิธีการใช้** ใช้ในการเติมน้ำครั้งแรก และทุกครั้งที่มีการเติมน้ำในสระเพิ่ม ภายใน 1-2 วัน ก่อนเติมคลอรีน เมื่อใสแล้วสามารถว่ายน้ำได้หลังจากเดินระบบหมุนเวียนน้ำ 1 Turnover

**อัตราส่วน** 225 ซีซี ต่อน้ำ 19 ลบ.ม (12 ซีซี ต่อน้ำ 1 ลบ.ม.)



Code	Model	Description	Packing	Retail Price	Code✘
14001610020	StainTrine (QT)	น้ำยาป้องกันและแก้ปัญหาคราบน้ำสนิม และตะกรัน	Quart	840.00	G ★
14001610050	StainTrine (GL)	Stain & Scale Preventer and Water Decoloration	Gallon	2,290.00	

### SANITRINE

Acts as cleaner, disinfectant, deodorant and fungicide

- Removes dirt, grime, grease and oil, as it prevents odour and kills germs
- Ideal for use on pool walls and decks
- Effective against the pathogenic fungus

Simply mix 60 cc of SANITRINE per 1 litre of water and wipe or scrub surface with damp cloth or mop

**คุณสมบัติ** เช็ดคราบสกปรกและคราบมันบริเวณขอบสระช่วยให้คราบหลุดออกโดยง่าย  
**วิธีการใช้** เมื่อเกิดคราบสกปรกหรือคราบมันบริเวณขอบสระใช้ฟองน้ำชุบแล้วเช็ดตามขอบสระจนสะอาด



Code	Model	Description	Packing	Retail Price	Code✘
14001610025	SaniTrine (QT)	น้ำยาเช็ดคราบสกปรก คราบไขมันขอบสระ	Quart	840.00	G ★
14001610055	SaniTrine (GL)	Cleaner for Tile-Fungicide Disinfectant-Deodorant	Gallon	2,290.00	

Code	Model	Description	Retail Price	Code✘
14001610060	HiClean (GL)	น้ำยาล้างพื้นและล้างแผ่นกรอง Clean the grid element inside the D.E. filter	2,290.00	G ★

หมายเหตุ : ราคายังไม่รวมภาษี 7% บริษัทฯ ขอสงวนสิทธิ์ในการเปลี่ยนแปลงราคาโดยไม่ต้องแจ้งให้ทราบล่วงหน้า

Remarks : Excluded VAT 7%. The Company reserves the right to change the prices without announcement.



# Standard Algaecides

## SWIM ADVANCE



Effectively and economically kills algae and prevents regrowth without requiring pool closure.

- For visible algae growth : Apply 330 cc of Swim Advance per 19 cu.m of pool water everyday 7 days
- Prevention of algae : Apply 165 cc of Swim Advance per 19 cu.m of pool water everyday 10-14 days.

## BLACK ADVANCE



The best available product for controlling black algae's innate resistance to chemical

- With Visible Algae Growth: Apply 990 cc Of Black Advance per 19 cu.m of pool water 5 days. Settled algae debris may be removed by vacuuming.

## POOL ADVANCE



An algaecide water clarifier suitable for D.E Filter

- For treatment of a freshly clean and filled pool: Apply 750 cc of Pool Advance per 19 cu.m of pool water everyday 5 days
- Maintained treatment: Apply 375 cc of Pool Advance per 19 cu.m of pool water everyday 7 days.

## STAIN ADVANCE



Stain & scale preventer and remover

- New pool filling : Apply 563 cc of Stain Advance per 19 cu.m of pool water and run filter 24 hours before adjust free chlorine to 1.5 ppm and pH 7.6-7.6.

## CLEAR ADVANCE



An algaecide water clarifier suitable for sand filters

- For very cloudy water : Apply 150 cc of Clear Advance per 19 cu.m of water and run filter 24 hours until clear.
- For maintenance : Apply 75 cc of Clear Advance per 19 cu.m of pool water every 2 weeks.

## SANI ADVANCE



Acts as cleaner, disinfectant, deodorant and fungicide

- Simply mix 120 cc of SANITRINE per 1 litre of water and wipe or scrub surface with damp cloth or mop.

Code	Model	Description	Packing	Retail Price	Code✕
14001610065	Swim Advance	น้ำยากำจัดไคร้สีเขียว Algaecide Kill Green & Mustard Algae	Gallon	1,090.00	G★
14001610070	Pool Advance	น้ำยาแก้ปัญหาน้ำขุ่นน้ำเขียวสำหรับเครื่องกรองผ้า Algaecide & Water Clarifier Suitable for D.E. Filter	Gallon	1,090.00	
14001610075	Clear Advance	น้ำยาช่วยให้น้ำใสเร็ว สำหรับเครื่องกรองทราย Algaecide & Water Clarifier Suitable for Sand Filter	Gallon	1,090.00	
14001610080	Black Advance	น้ำยากำจัดตะไคร้ดำ Algaecide Control Black & Other Resistant Forms	Gallon	1,090.00	
14001610085	Stain Advance	น้ำยาป้องกันและแก้ปัญหาคาบสนิมและตะกรัน Stain & Scale Preventer and Water Decoloration	Gallon	1,090.00	
14001610090	Sani Advance	น้ำยาเช็ดคราบสกปรก คราบไขมันขอบสระ Cleaner for Tile-Fungicide Disinfectant-Deodorant	Gallon	1,090.00	

หมายเหตุ : ราคายังไม่รวมภาษี 7% บริษัทฯ ขอสงวนสิทธิ์ในการเปลี่ยนแปลงราคาโดยไม่ต้องแจ้งให้ทราบล่วงหน้า  
Remarks : Excluded VAT 7%. The Company reserves the right to change the prices without announcement.



## pH & CL Test Solutions

### INSTRUCTIONS

- Fill pool water in the TEST KIT CELLS
  - Use 5 drops of test solution
  - Read values by comparing to the colour standards on the TEST KIT
- Chlorine value should be : 1.0 – 1.5 ppm    pH Value should be : 7.2 – 7.6



Code	Model	Packing	Retail Price	Code✘
14001610115	pH & CL Refill	30 CC/Bottle	420.00	G ★

## Salinity Solution



Code	Model	Description	Packing	Retail Price	Code✘
24000510010	CS-Liquid	Calibration Solution for Digital Salt Meter, 45 ppt Nacl	30 CC/Bottle	210.00	A ★

## Pool Salt



Code	Model	Water Capacity (m <sup>3</sup> )	Packing	Retail Price	Code✘
24003000015	Pool Salt	For Salt Water Pool	25 kgs/bag	290.00	A

## Soda Ash

Code	Model	Description	Packing	Retail Price	Code✘
14003100010	Soda Ash-40	2 กก. ต่อ น้ำ 100 คิว เมื่อค่า pH ต่ำกว่า 7.2 Use 2 kgs per 100 m <sup>3</sup> of water if the pH level is lower than 7.2	40 kgs/bag	1.690.00	B

## Hydrochloric Acid



Code	Model	Description	Packing	Retail Price	Code✘
14001610120	HC-1	3 ลิตร ต่อ น้ำ 100 คิว เมื่อค่า pH สูงกว่า 7.6 3 litres per 100 m <sup>3</sup> of water when pH is higher than 7.6	1 Gallon	590.00	B
14001610125	HC-25		25 kgs/drum	1,100.00	

หมายเหตุ : ราคายังไม่รวมภาษี 7% บริษัทฯ ขอสงวนสิทธิ์ในการเปลี่ยนแปลงราคาโดยไม่ต้องแจ้งให้ทราบล่วงหน้า  
Remarks : Excluded VAT 7%. The Company reserves the right to change the prices without announcement.



# “KENITE” Diatomite Powder For D.E. Filters

## THE WORLD'S LARGEST PRODUCER OF DIATOMITE FILTRATION AND FUNCTIONAL ADDITIVE PRODUCTS

IMERYS is a leading supplier of engineered mineral products derived from diatomite (also called diatomaceous earth or D.E.) and expanded perlite, natural raw materials possessing unusually light density, chemical inertness, high surface area and intricate structure. As a result of these unusual properties, the company's products are used in a host of applications, including filtration for liquid/solid separation, functional fillers for paints, coatings, polymers and elastomers, bioreactor support, and in the promotion of plant growth

### Kenite Diatomite Swimming Pool Powder:

A high-quality, flux-calcined diatomite filter aid for use in swimming pool filter. This powder provides brilliant water clarity by removing fine suspended-solids and even certain bacteria. It provides excellent flow rate and clarity in pressure vacuum filter system.

### PRODUCT

Type	Filter Aid
Description	Flux Calcined Diatomite

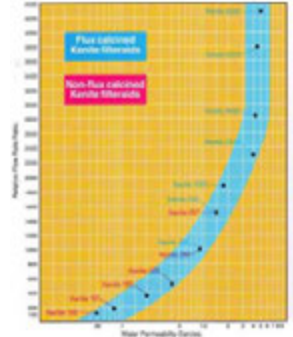

### TYPICAL PHYSICAL PROPERTIES

Colour	White
Appearance	Fine Powder
Density Wet, lbs/ft3(g/cc)	22.0(0.35)
Permeability (Darcy)	4.6
150 Mesh Screen Analysis, % retain	26.0
Median Particle Size, microns	53.1
pH	10.0
Specific Gravity	2.3
Moisture, as shipped (%)	0.1



## Premium Diatomite Powder Made In USA

Code	Model	Description	Packing	Retail Price	Code✘
14003100000	Kenite 3000	Premium Grade D.E. Powder for Swimming Pool From USA.	22.7 kgs/bag	1,390.00	B ★



## Standard Diatomite Powder

Code	Model	Description	Packing	Retail Price	Code✘
14003000000	Kenite 700	Standard Grade D.E. Powder	22.5 kgs/bag	กรุณาติดต่อเจ้าหน้าที่ / Please Check with Sales Assistance	

หมายเหตุ : ราคายังไม่รวมภาษี 7% บริษัทฯ ขอสงวนสิทธิ์ในการเปลี่ยนแปลงราคาโดยไม่ต้องแจ้งให้ทราบล่วงหน้า  
Remarks : Excluded VAT 7%. The Company reserves the right to change the prices without announcement.





## Chlorine Liquid 10%

Code	Model	Description	Packing	Retail Price	Code✖
14003000025	CL Liquid 10%	คลอรีนน้ำ 10% Chlorine Liquid 10% Sodium hypochlorite	25 kgs/drum	1,200.00	Z

## Sodium Bicarbonate



Code	Model	Description	Packing	Retail Price	Code✖
14002100030	Sodium-Bi-5	170 กรัม ต่อ น้ำ 10 คิว เมื่อค่า pH ต่ำกว่า 7.2 เพื่อเพิ่มค่าความเป็นด่าง 10 ppm Use 170 grams per 10 m <sup>3</sup> of water if the pH	5 kgs/drum	920.00	B
14002100035	Sodium-Bi-25	level is lower than 7.2 in order to increase alkalinity 10 ppm	25 kgs/bag	1,320.00	

## “POXY PUTTY” Tiles Epoxy

### FEATURES

- Cures off-white in color
- Can be sanded or painted
- Mix ratio is 1:1
- Sets up in 3-4 hours at 75° F.
- Cures in 24 hours at 75° F.



Code	Model	Description	Packing	Retail Price	Code✖
23613100005	Poxy Putty	กาวปะกระเบื้องใต้น้ำ Underwater Swimming Pool Tiles Epoxy	340 grams/can	กรุณาติดต่อเจ้าหน้าที่ / Please Check with Sales Assistance	

## Vinyl Adhesive



Code	Model	Description	Packing	Retail Price	Code✖
22213100010	Vinyl Adhesive	กาวปะผ้าไวนิลใต้น้ำ Vinyl Liner Glue	118.3 ml/can	กรุณาติดต่อเจ้าหน้าที่ / Please Check with Sales Assistance	

หมายเหตุ : ราคายังไม่รวมภาษี 7% บริษัทฯ ขอสงวนสิทธิ์ในการเปลี่ยนแปลงราคาโดยไม่ต้องแจ้งให้ทราบล่วงหน้า  
Remarks : Excluded VAT 7%. The Company reserves the right to change the prices without announcement.

# COMPLETE SET SWIMMING POOLS





## “SWIM SPA” Fiberglass Pool Complete Set



- SwimSpa is revolutionizing the swimming pool and spa industry. Great for relaxation health, fitness, general pain relief & entertainment
- SwimSpa takes less than 15 minutes a week to assure sparkling clean water
- The perfect home exercise option for people of all ages and interests
- Compact, quick & easy to install

If you are looking for a swimming pool, hot tub or Jacuzzi, or are interested in hydrotherapy hydro massage, or general exercises and if you suffer from back pain or tension consider a SwimSpa

### CAN EASILY BE REMOVED AND TRANSPORTED



### SYSTEM INCLUDED

- SwimSpa Fiberglass Pool
- Cast Iron Support
- Standard Filtration System Complete set with Automatic Timer Controller
- Counter Swim Jet System with LED Light Colour Change
- Spa Jacuzzi System with 2 Seating Area
- Underwater Light LED 10W/12V Warm White
- Maintenance Kit Set
- Chemical for Commissioning water

### OPTIONS

- Salt Chlorinator or Freshwater Systems
- Heating System
- Decoration wood around SwimSpa

### EXCLUDE

- Foundation base
- Delivery



# PRICE LIST 2023

# COMPLETE SET SWIMMING POOL

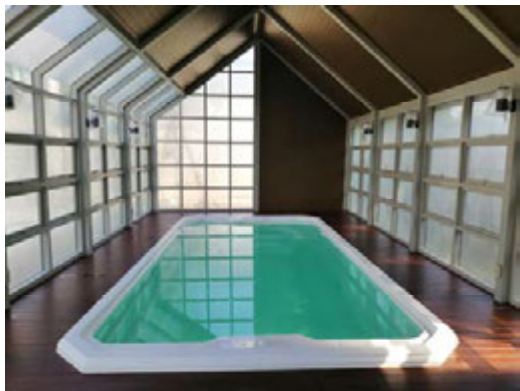

Model	Filtration System	Chlorine Feeder	LED UW Light	Swim Jet	Spa Jet 2 Seats	Maintenance Kits	Chemicals for Commissioning
POOL – 01	✓	✓	✓			✓	✓
POOL – 02	✓	✓	✓			✓	✓
SWIM SPA – 01	✓	✓	✓	✓	✓	✓	✓
SWIM SPA – 02	✓	✓	✓	✓	✓	✓	✓

## Fiberglass Pool Complete Set

Code	Model	Size (meters)	Retail Price	Code✘
20101610070	POOL-01 ✘	2.45 x 4.45 x 1.20	กรุณาติดต่อเจ้าหน้าที่ / Please Check with Sales Assistance	
20101610075	POOL-02 ✘	3.00 x 6.00 x 1.20		
20101610005	SWIM SPA-01 ✘	2.45 x 4.45 x 1.20		
20101610010	SWIM SPA-02 ✘	3.00 x 6.00 x 1.20		

✘ สินค้าไม่มีสต็อก กรุณาสั่งซื้อล่วงหน้า / No Stock, Delivery Time : 30 - 60 Days

## Options Decoration wood

Code	Options	Descriptions	Retail Price	Code✘
20101610080	SWIM SPA-DW-01	Decoration wood for size 2.45 x 4.45 x 1.20 Complete with installation	กรุณาติดต่อเจ้าหน้าที่ / Please Check with Sales Assistance	
20101610085	SWIM SPA-DW-02	Decoration wood for size 3.00 x 6.00 x 1.20 Complete with installation		

## Options Mosaic tiles

Code	Options	Descriptions	Retail Price	Code✘
20101610090	SWIM SPA-MT-01	Mosaic tiles for size 2.45 x 4.45 x 1.20 Complete with installation	กรุณาติดต่อเจ้าหน้าที่ / Please Check with Sales Assistance	
20101610095	SWIM SPA-MT-02	Mosaic tiles for size 3.00 x 6.00 x 1.20 Complete with installation		

หมายเหตุ : ราคายังไม่รวมภาษี 7% บริษัทฯ ขอสงวนสิทธิ์ในการเปลี่ยนแปลงราคาโดยไม่ต้องแจ้งให้ทราบล่วงหน้า  
Remarks : Excluded VAT 7%. The Company reserves the right to change the prices without announcement.

An underwater photograph of a woman with dark hair, looking directly at the camera. She is swimming, and there are many bubbles around her head. The water is a deep blue color. The word "FILTERS" is written in white, bold, capital letters in the upper right quadrant of the image.

**FILTERS**



## Quality Sand Filters

Residential and Commercial Swimming Pools, Spas & Industry

Suitable for all filtration applications including:-

- Swimming pools - from domestic to olympic size
- Spa's
- Waste water treatment
- Aqua culture
- Irrigation systems
- Drinking water processing
- Water supply treatment
- Industrial water treatment



- |  |   |
|--|---|
| <ul style="list-style-type: none"> <li>● <b>Residential</b><br/>Hi-Rate Sand Filters</li> <li>● <b>Light-Medium Commercial</b><br/>Standard Media Depth Sand Filters</li> <li>● <b>Heavy Commercial</b><br/>Medium Media Depth Sand Filters</li> </ul> | <ul style="list-style-type: none"> <li>● <b>Deep Bed Commercial</b><br/>Maximum Media Depth Sand Filters</li> <li>● <b>Industrial</b><br/>High Pressure Standard Media Depth Filters</li> </ul> |
|--|---|





# “SANDIA” SSR-T Series, Top Mount Laminated Commercial Hi-Rate Sand Filters Complete Set With Multiport Valves

**SUITABLE FOR ALL FILTRATION APPLICATIONS INCLUDING**

- Swimming pools – from domestic to Olympic size
- Spa's
- Waste water treatment
- Aqua culture
- Irrigation systems
- Drinking water processing
- Water supply treatment
- Industrial water treatment

The SSR Range is ideally suitable for permanent in-ground residential indoor or outdoor pools. The main tank structure is made from extremely hard wearing glass reinforce polyester. The smooth high gloss internal and external finish ensure free flow and easy cleaning. The side mounted multiport valve configuration together with the large lid access (230mm diameter) allows servicing of the interior without the need to disturb the connecting pipe-work.

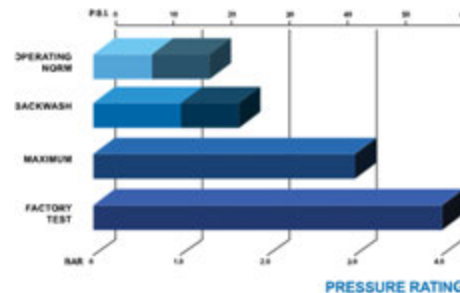
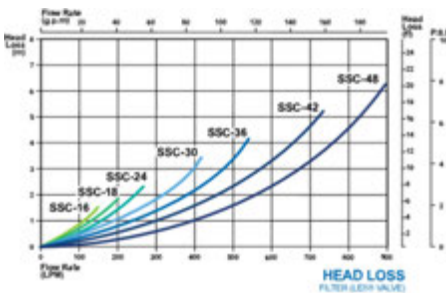

Code	Model	MV (inches)	Flowrate (gpm)	Flowrate (m³/h)	Height (cm)	Width (inches)	Sand (50kgs/bag)	Zelbrite (15kgs/bag)	EcoClear (25kgs/bag)		Retail Price	Code ✖
									Coare	Fine		
20311900040	SSR24-T-1.5	1.5	55	12.50	100	24	3	8	1	3	28,000.00	H★
20311900060	SSR28-T-2	2	83.60	19	103	28	4	10	2	4	35,000.00	
20311900070	SSR30-T	2	90.20	20.50	105	30	5	13	2	6	37,000.00	
20311900080	SSC32-T	2	106.04	24.10	105	32	5	13	2	6	39,000.00	
20311900090	SSC36-T	2	127.60	29	110	36	8	20	4	9	47,000.00	
20311900100	SSC42-T	2	178.20	40.50	130	42	11	28	5	12	59,000.00	

✖✖ ราคารวมสารกรองทราย / Included Sand Media

หมายเหตุ : ราคายังไม่รวมภาษี 7% บริษัทฯ ขอสงวนสิทธิ์ในการเปลี่ยนแปลงราคาโดยไม่ต้องแจ้งให้ทราบล่วงหน้า  
 Remarks : Excluded VAT 7%. The Company reserves the right to change the prices without announcement.



# “SANDIA” SSR-S Series, Side Mount Laminated Commercial Hi-Rate Sand Filters Complete Set With Multiport Valves

**SUITABLE FOR ALL FILTRATION APPLICATIONS INCLUDING**

- Swimming pools – from domestic to Olympic size
- Spa's
- Waste water treatment
- Aqua culture
- Irrigation systems
- Drinking water processing
- Water supply treatment
- Industrial water treatment

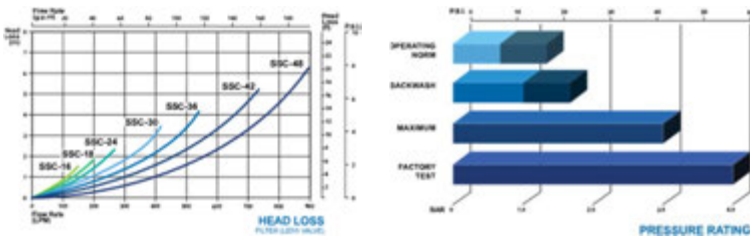

Code	Model	MV (inches)	Flowrate (gpm)	Flowrate (m³/h)	Height (cm)	Width (inches)	Sand (50kgs/bag)	Zelbrite (15kgs/bag)	EcoClear (25kgs/bag)		Retail Price	Code ✖
									Coare	Fine		
20311900005	SSR16-S	1.5	23.10	5.25	85	16	1	4	1/2	1	25,000.00	
20311900010	SSR18-S	1.5	33	7.50	85	18	2	5	1	2	28,000.00	
20311900020	SSR21-S	1.5	48.40	11	76	21	2	5	1	2	28,000.00	
20311900035	SSR24-S	1.5	55	12.50	76	24	3	8	1	3	31,000.00	
20311900125	SSR28-S-2	2	83.60	19	83	28	4	10	2	4	37,000.00	
20311900065	SSR30-S	2	90.20	20.50	85	30	5	13	2	6	38,000.00	H★
20311900075	SSC32-S	2	106.04	24.10	94	32	5	13	2	6	42,000.00	
20311900085	SSC36-S	2	127.60	29	100	36	8	20	4	9	52,000.00	
20311900105	SSC42-S-2.5	2.5 Emaux	178.20	40.50	130	42	11	28	5	12	92,000.00	
20311900115	SSC48-S-3	3 Emaux	233.20	53	145	48	17	43	8	18	129,000.00	

✖✖ ราคารวมสารกรองทราย / Included Sand Media

หมายเหตุ : ราคายังไม่รวมภาษี 7% บริษัทฯ ขอสงวนสิทธิ์ในการเปลี่ยนแปลงราคาโดยไม่ต้องแจ้งให้ทราบล่วงหน้า  
 Remarks : Excluded VAT 7%. The Company reserves the right to change the prices without announcement.





# “SANDIA” DBK Series Deep Bed Laminated Hi-Rate Sand Filters Complete Set With Multiport Valves

All DBK Superflow filters can operate with either silica sand or sand gravel mix. They are suitable for use in commercial applications such as spa pools, high bathing load swimming pools, fish farming, industrial water treatment, drinking water system, etc.

The depth of media (1.2 m) ensures that even the finest dirt particles are retained.

The media sight glass (optional extra) is made high quality toughened safety glass which will resist damage by erosion.

The top oval lid allows easy access to the internals whilst the large side access manhole enable easy media removal, inspection and access to the filter.

The plate and nozzle system allows a uniform undisturbed flow through the media bed for filtering. The plate system also allows the use of air purging as part of the backwash procedure, thus reducing the water required for backwashing.

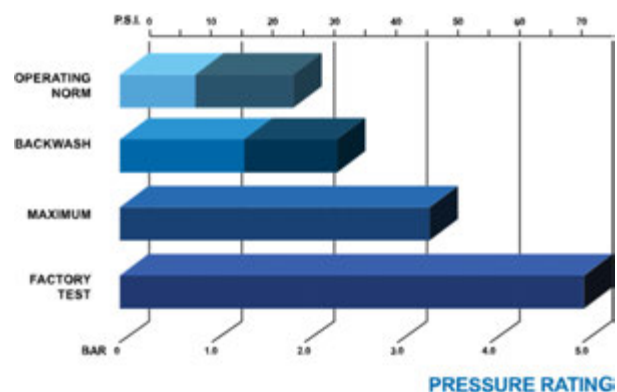
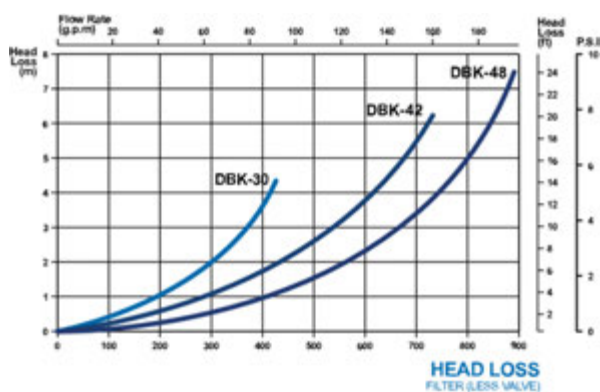

## Technical Information

Code	Model	Multi-port Valve (inches)	Flowrate (gpm)	Flowrate (m³/h)	Sand (50kgs/bag)	Zelbrite (15kgs/bag)	EcoClear (25kgs/bag)	
							Coare	Fine
20301900005	DBK 30	2	73	20	19	47	9	20
20301900020	DBK 42	3	160	43	42	105	21	42
20301900030	DBK 48	3	186	50	46	115	23	46

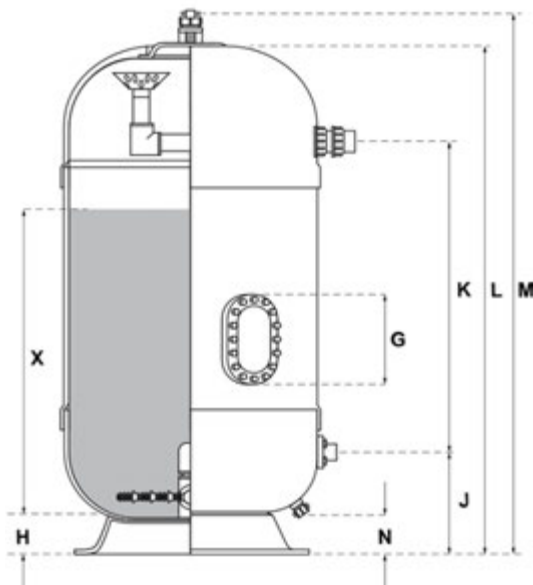
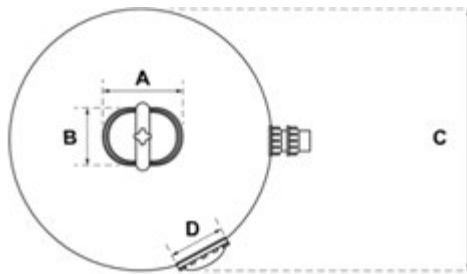

**Product Dimensions (meter)**

Type	DBK-30	DBK-42	DBK-48
A	0.27	0.27	0.43
B	0.23	0.23	0.33
C	0.78	1.14	1.24
D	0.32	0.46	0.46
G	0.30	0.54	0.54
H	0.10	0.11	0.12
J	0.28	0.31	0.35
K	1.65	1.70	1.75
L	2.22	2.36	2.48
M	2.30	2.42	2.42
N	0.10	0.11	0.12
X	1.50	1.51	1.53

Code	Model	MV (inches)	Flowrate (gpm)	Flowrate (m <sup>3</sup> /h)	Height (cm)	Width (inches)	Sand (50kgs/bag)	Zelbrite (15kgs/bag)	EcoClear (25kgs/bag)		Retail Price	Code ✖
									Coare	Fine		
20301900005	DBK-30 ✖	2	73	20	230	31.2	19	47	9	20	69,000.00	B
20301900020	DBK-42 ✖	3	160	43	242	45.2	42	105	21	42	119,000.00	
20301900030	DBK-48 ✖	3	186	50	242	49.0	46	115	23	46	139,000.00	

✖✖ ราคารวมสารกรองทราย / Included Sand Media

✖ สินค้าไม่มีสต็อก กรุณาสั่งซื้อล่วงหน้า / No Stock, Delivery Time : 7 - 14 Days

หมายเหตุ : ราคายังไม่รวมภาษี 7% บริษัทฯ ขอสงวนสิทธิ์ในการเปลี่ยนแปลงราคาโดยไม่ต้องแจ้งให้ทราบล่วงหน้า  
Remarks : Excluded VAT 7%. The Company reserves the right to change the prices without announcement.



# “SANDIA” HZC Series Horizontal Laminated Hi-Rate Sand Filters Without Multiport Valves

SANDIA filters are suitable for removing suspended dirt particles from water at high speed efficiently and economically, in both fresh and salt water conditions. Sandia filters are constructed from totally corrosion resistant materials to ensure trouble free running and prolonged life. Each filter is rigorously pressure tested to the highest standards and certified as correct prior leaving the factory



## THE SPAVE SAVING HIGH PERFORMANCE

If the budget didn't leave the finance for a ballroom, as a plant room, SANDIA have a perfect answer. Unlike conventional circular filter designs – SANDIA produces commercial filters with a difference (oval). As you can see by the illustrations opposite, the SANDIA 42” HORIZONTAL filter can be installed with the minimum of wasted space.

Not only will the plant room COST LESS to build (approximately 20%) but the pipework runs can also be kept down to a minimum, again saving money. This may also have the effect of making the operation of the equipment more efficient.

Furthermore conventional filters above the size of 1 meter diameter are usually designed to have a hemispherical style with profile. With this type of design the filter tank will require on average 30% more media than a SANDIA horizontal, to operate at optimum performance.

Finally the SANDIA Horizontal filter is only 1110 mm wide and will easily fit through most plant room doors. All round the SANDIA Horizontal is a winner saving your money and giving you total peace of mind.

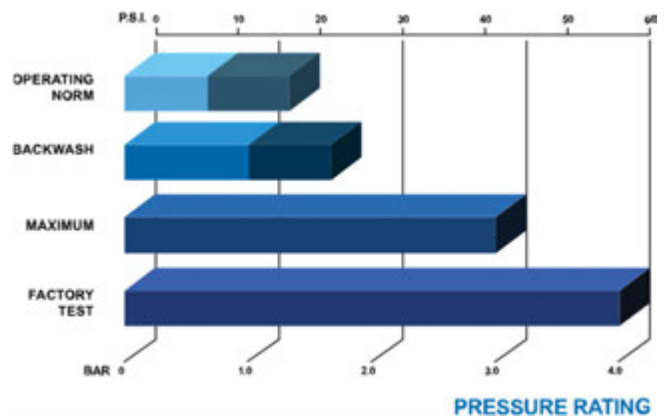
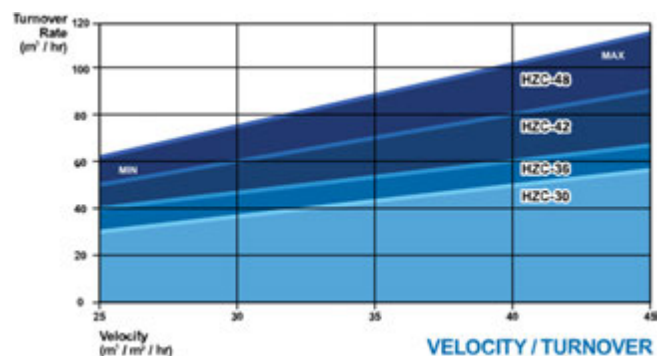

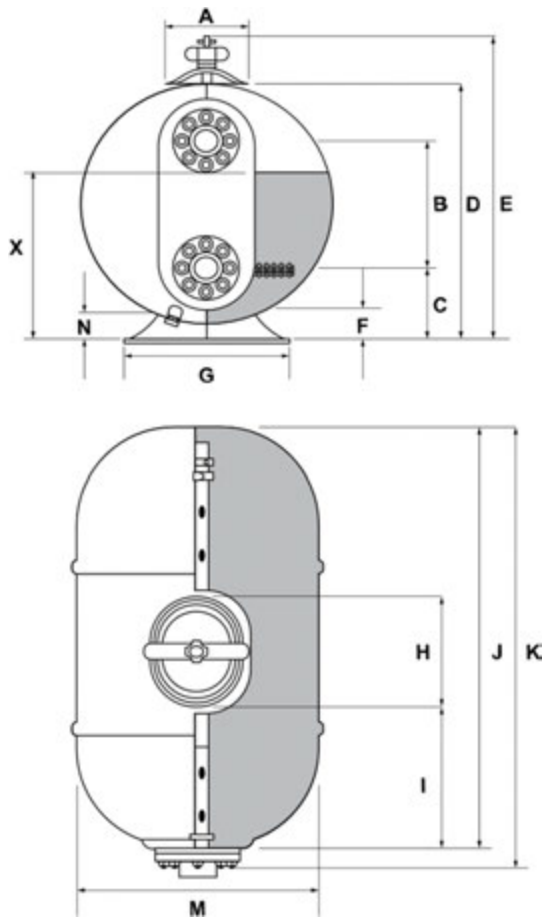

Product Dimensions (meter)

Type	HZC-30	HZC-36	HZC-42	HZC-48
A	0.30	0.33	0.33	0.33
B	0.39	0.56	0.70	0.85
C	0.28	0.29	0.32	0.38
D	1.05	1.15	1.26	1.38
E	1.12	1.23	1.34	1.45
F	0.12	0.15	0.19	0.22
G	0.57	0.72	0.81	0.90
H	0.30	0.43	0.43	0.43
I	0.75	0.77	0.80	1.01
J	1.95	1.96	1.98	2.38
K	1.95	1.95	2.15	2.15
M	0.79	0.97	1.14	1.35
N	0.17	0.18	0.19	0.21
X	0.46	0.57	0.66	0.71

Code	Model	In&Outlet (inches)	Flowrate (gpm)	Flowrate (m <sup>3</sup> /h)	Height (cm)	Width (inches)	Length (cm)	Sand (50kgs/bag)	Zelbrite (15kgs/bag)	EcoClear (25kgs/bag)		Retail Price	Code ✳
										Coare	Fine		
20301900010	HZC-30 ✳	4	205	56	111.50	31	195	15	38	7	16	68,000.00	B
20301900015	HZC-36 ✳	4	246	67	122.50	38	195	19	48	9	20	76,000.00	
20301900025	HZC-42 ✳	4	330	90	133.50	45	215	24	60	12	24	87,200.00	
20301900035	HZC-48 ✳	5	414	113	145.00	53	215	32	80	16	32	119,200.00	

✳✳ ราคาไม่รวมสารกรองทราย / Included Sand Media

✳ สินค้าไม่มีสต็อก กรุณาสั่งซื้อล่วงหน้า / No Stock, Delivery Time : 7 - 14 Days

หมายเหตุ : ราคายังไม่รวมภาษี 7% บริษัทฯ ขอสงวนสิทธิ์ในการเปลี่ยนแปลงราคาโดยไม่ต้องแจ้งให้ทราบล่วงหน้า  
Remarks : Excluded VAT 7%. The Company reserves the right to change the prices without announcement.



# “EMAUX” MAX (MFV) Series Top Mount Sand Filters Complete Set With Multiport Valves

## MAX TOP MOUNT FILTER IS EQUIPPED WITH

- 6-way clamp style multiport valve  
(Size 1.5” – MPV07 & Size 2.” – MPV08)
- Universal standard of union connection
- Pressure gauge
- PVC & ABS lateral system

Emaux innovative design and advance technology offers superior filtration performance and crystal clear water. Max Series filters are blown at one-piece with high density polyethylene for its heavy duty performance and reliability.

- Innovative design and advance technology
- One-piece with high density polyethylene filter tank
- Heavy duty performance & reliability
- Multi-port valve unique one-piece clamp with screw-type lock allow tool-free service
- Max operating pressure 40 psi / 2.8 bar
- Max temperature 50 C (122 F)
- Universal standard of union connection provided
- ABS lateral provided



<b>Tank Material</b>	<b>Max Operating Pressure</b>	<b>Max Temperature</b>
HDPE	40 psi / 2.8 bar	50°C (112°F)

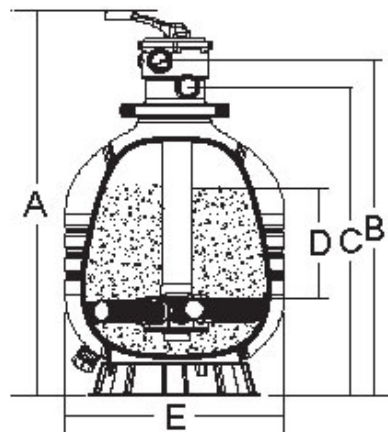

## Product Dimensions:

Model	A mm	B mm	C mm	D mm	E mm
MFV17	816	695	625	195	425
MFV20	889	772	712	225	500
MFV24	980	860	800	280	600
MFV248	1032	873	807	280	600
MFV27A	1081	963	903	300	675
MFV27	1133	976	910	300	675
MFV31A	1126	1008	948	370	775
MFV31	1178	1021	955	370	775
MFV35	1296	1139	1073	440	875



1. Unique one-piece clamp with screw-type lock design to simplify installation and allow tool-free servicing
2. Equipped with 6-way multiport valve which is constructed with sturdy ABS and marine-grade stainless steel
3. Easy-to-read pressure gauge for easy inspection



Code	Model	MV (inches)	MPV Model	Flowrate (gpm)	Flowrate (m <sup>3</sup> /h)	Height (cm)	Width (inches)	Sand (50kgs/bag)	Zelbrite (15kgs/bag)	EcoClear (25kgs/bag)		Retail Price	Code ✖
										Coare	Fine		
20310510015	MFV17	1.5	MPV07	3.00	7.00	81.6	17	1	2	1/2	1	10,800.00	
20310510035	MFV20	1.5	MPV07	46.20	10.00	88.9	20	2	4	1	2	12,100.00	
20310510060	MFV24	1.5	MPV07	62.92	14.00	98.0	24	3	7	1	3	15,900.00	
20310510085	MFV27A	1.5	MPV07	85.80	14.40	108.1	27	4	10	2	4	18,800.00	H★
20310510090	MFV27	2	MPV08	89.32	18.00	113.3	27	4	10	2	4	20,300.00	
20310510130	MFV31	2	MPV08	108.99	23.50	117.8	31	7	16	3	8	27,800.00	
20310510155	MFV35	2	MPV08	136.24	30.50	129.60	35	9	22	4	10	34,400.00	

✖✖ ราคารวมสารกรองทราย / Included Sand Media



หมายเหตุ : ราคายังไม่รวมภาษี 7% บริษัทฯ ขอสงวนสิทธิ์ในการเปลี่ยนแปลงราคาโดยไม่ต้องแจ้งให้ทราบล่วงหน้า  
 Remarks : Excluded VAT 7%. The Company reserves the right to change the prices without announcement.



# “EMAUX” MAX (MFS) Series Side Mount Sand Filters Complete Set With Multiport Valves

**MAX SIDE MOUNT FILTER IS EQUIPPED WITH**

- 6-way clamp style multiport valve  
(Size 1.5” – MPV03 & Size 2.” – MPV04)
- Universal standard of union connection
- Pressure gauge
- PVC & ABS lateral system

Emaux innovative design and advance technology offers superior filtration performance and crystal clear water. Max Series filters are blown at one-piece with high density polyethylene for its heavy duty performance and reliability.

- Innovative design and advance technology
- One-piece with high density polyethylene filter tank
- Heavy duty performance & reliability
- Multi-port valve unique one-piece clamp with screw-type lock allow tool-free service
- Max operating pressure 40 psi / 2.8 bar
- Max temperature 50 C (122 F)
- Universal standard of union connection provided
- ABS lateral provided



1. Unique one-piece clamp with screw-type lock design to simplify installation and allow tool-free servicing
2. Equipped with 6-way multiport valve which is constructed with sturdy ABS and marine-grade stainless steel
3. Easy-to-read pressure gauge for easy inspection



Tank Material	Max Operating Pressure	Max Temperature
HDPE	40 psi / 2.8 bar	50°C (112°F)

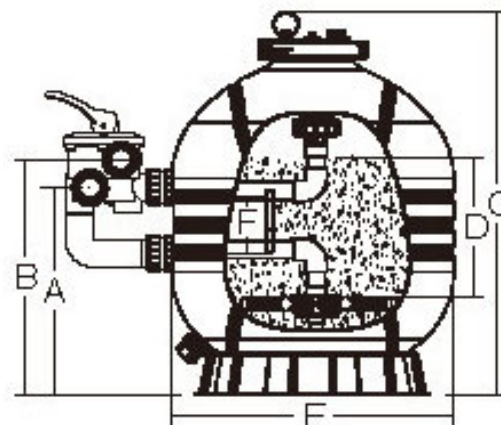

**Product Dimensions:**

Model	A mm	B mm	C mm	D mm	E mm	F mm
MFS17	355	418	670	195	425	125
MFS20	396	549	760	225	500	125
MFS24	430	493	825	280	600	125
MFS27A	480	543	946	300	675	125
MFS27	460	546	946	300	675	130
MFS31A	506	569	968	370	775	125
MFS31	508	594	968	370	775	130
MFS35	564	650	1086	440	875	130



Code	Model	MV (inches)	MPV Model	Flowrate (gpm)	Flowrate (m <sup>3</sup> /h)	Height (cm)	Width (inches)	Sand (50kgs/bag)	Zelbrite (15kgs/bag)	EcoClear (25kgs/bag)		Retail Price	Code ✖
										Coare	Fine		
20310510020	MFS17	1.5	MPV03	30.00	7.00	67.00	17	1	2	1/2	1	11,700.00	
20310510040	MFS20	1.5	MPV03	46.20	10.00	76.00	20	2	4	1	2	12,900.00	
20310510065	MFS24	1.5	MPV03	62.92	14.00	82.00	24	3	7	1	3	16,400.00	
20310510095	MFS27A	1.5	MPV03	85.80	14.40	94.60	27	4	10	2	4	20,900.00	H★
20310510100	MFS27	2	MPV04	89.32	18.00	94.60	27	4	10	2	4	25,200.00	
20310510135	MFS31	2	MPV04	108.99	23.50	96.80	31	7	16	3	8	33,000.00	
20310510160	MFS35	2	MPV04	136.24	30.50	108.60	35	9	22	4	10	40,900.00	

✖✖ ราคารวมสารกรองทราย / Included Sand Media



หมายเหตุ : ราคายังไม่รวมภาษี 7% บริษัทฯ ขอสงวนสิทธิ์ในการเปลี่ยนแปลงราคาโดยไม่ต้องแจ้งให้ทราบล่วงหน้า  
 Remarks : Excluded VAT 7%. The Company reserves the right to change the prices without announcement.





# “EMAUX” V Series Bobbin-Wound Top Mount Sand Filters Complete Set With Multiport Valves

**V SERIES FILTER IS EQUIPPED WITH**

- 6-way clamp/bolt style multiport valve  
(Size 1.5” – MPV01 & Size 2.” – MPV02 & Size 2.5” – MPV12)
- Universal standard of union connection
- Pressure gauge
- lateral system

Bobbin-wound fiberglass reinforced tank is till the most popular standard in the industry after all. With UV-resistance surface finish, it is able to operate under prolong sunlight for years of reliability.

**Tank Material**

Bobbin Wound Reinforced Fiberglass

**Max Operating Pressure**

36 psi / 2.5 bar

**Max Temperature**

43°C (109°F)

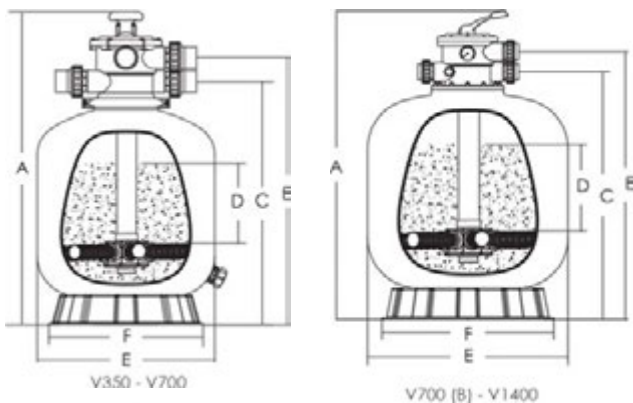

**Product Dimension:**

Model No	A mm	B mm	C mm	D mm	E mm	F mm
V350	726	619	550	160	355	298
V400	757	640	590	175	410	390
V450	814	698	638	210	455	390
V500	845	730	670	235	535	500
V650,V650PB	950	835	775	300	635	500
V650(B)	957	815	731	300	635	500
V700	1020	905	845	330	710	500
V700(B)	1092	960	877	390	723	500
V800	1200	1085	1002	425	800	780
V900	1300	1172	1090	480	900	780
V900(C)	1334	1242	1145	480	900	780
V1000	1400	1340	1260	580	1000	780
V1000(C)	1434	1410	1160	580	1000	780
V1200	1600	1550	1468	740	1200	1000
V1200(C)	1634	1620	1368	740	1200	1000
V1400	1845	1683	1586	750	1400	1000



Code	Model	MV (inches)	MPV Model	Flowrate (gpm)	Flowrate (m <sup>3</sup> /h)	Height (cm)	Width (inches)	Sand (50kgs/bag)	Zelbrite (15kgs/bag)	EcoClear (25kgs/bag)		Retail Price	Code ✖
										Coare	Fine		
20310510010	V400	1.5	MPV01	28.51	6.48	75.70	16	1	2	1/2	1	12,100.00	
20310510025	V450	1.5	MPV01	35.64	8.10	81.40	18	1	3	1/2	1	13,300.00	
20310510045	V500	1.5	MPV01	48.84	11.10	84.50	21	2	5	1	2	14,600.00	
20310510070	V650	1.5	MPV01	68.64	15.60	95.00	25	3	6	1	3	18,400.00	
20310510105	V700	1.5	MPV01	85.80	19.50	102.00	28	5	11	2	6	21,900.00	
20310510110	V700B	2	MPV02	85.80	20.16	102.00	28	5	11	2	6	24,500.00	
20310510140	V800	2	MPV02	109.56	24.90	120.00	32	8	18	4	9	35,200.00	H★
20310510165	V900	2	MPV02	137.28	31.20	130.00	36	10	24	4	11	40,000.00	
20310510175	V1000	2	MPV02	171.60	39.00	140.00	40	13	31	6	14	54,400.00	
20310510195	V1200	2	MPV02	227.04	51.60	160.00	48	18	43	8	19	69,600.00	
20310510180	V1000C	2.5	MPV12	174.07	39.50	143.40	40	13	31	6	14	62,000.00	
20310510200	V1200C	2.5	MPV12	248.94	56.50	163.40	48	18	43	8	19	75,800.00	

✖✖ ราคารวมสารกรองทราย / Included Sand Media

หมายเหตุ : ราคายังไม่รวมภาษี 7% บริษัทฯ ขอสงวนสิทธิ์ในการเปลี่ยนแปลงราคาโดยไม่ต้องแจ้งให้ทราบล่วงหน้า  
 Remarks : Excluded VAT 7%. The Company reserves the right to change the prices without announcement.



# “EMAUX” S Series Bobbin-Wound Side Mount Sand Filters Complete Set With Multiport Valves

**S SERIES FILTER IS EQUIPPED WITH**

- 6-way clamp/bolt style multiport valve  
(Size 1.5” – MPV03 & Size 2.” – MPV04 & Size 2.5” – MPV13)
- Universal standard of union connection
- Piping kits
- Pressure gauge
- lateral system

Bobbin-wound fiberglass reinforced tank is till the most popular standard in the industry after all. With UV-resistance surface finish, it is able to operate under prolong sunlight for years of reliability. Transparent lid is designed for easy inspection of sand bed.



**Tank Material**

Bobbin Wound Reinforced Fiberglass

**Max Operating Pressure    Max Temperature**

36 psi / 2.5 bar

43°C (109°F)

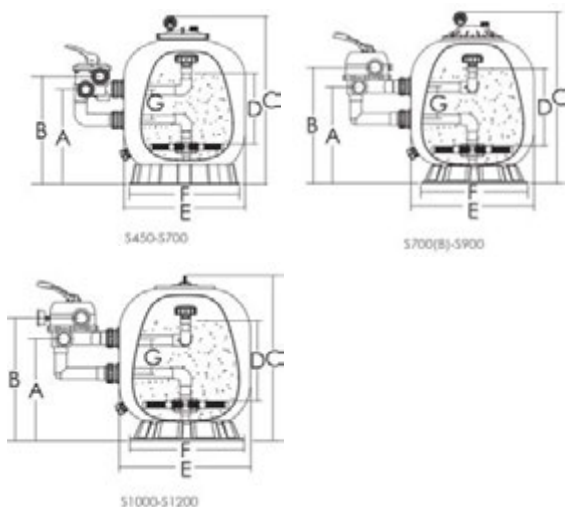

**Product Dimensions:**

Model No	A mm	B mm	C mm	D mm	E mm	F mm	G mm
S450	360	420	730	210	455	390	125
S500	390	450	770	235	535	500	125
S650	430	490	850	300	635	500	125
S700	450	510	960	330	710	500	125
S700(B)	520	606	890	390	723	500	220
S800	560	646	1050	425	820	780	220
S900	610	696	1180	480	920	780	220
S900(C)	673	744	1180	380	920	780	236
S1000	700	770	1220	580	1020	780	220
S1000(C)	773	844	1220	480	1020	780	236
S1200	820	1005	1410	740	1200	1000	220
S1200(C)	836	1079	1410	640	1200	1000	236



Code	Model	MV (inches)	MPV Model	Flowrate (gpm)	Flowrate (m <sup>3</sup> /h)	H (cm)	W (in)	Sand (50kgs /bag)	Zelbrite (15kgs/ bag)	EcoClear (25kgs/bag)		Retail Price	Code**
										Coare	Fine		
20310510030	S450	1.5	MPV03	35.00	8.10	73.00	18	1	3	1/2	1	14,500.00	
20310510050	S500	1.5	MPV03	48.00	11.10	77.00	21	2	5	1	2	16,200.00	
20310510075	S650	1.5	MPV03	68.00	15.60	85.00	25	3	6	1	3	20,300.00	
20310510115	S700	1.5	MPV03	85.00	19.50	96.00	28	5	11	2	6	22,800.00	
20310510120	S700B	2	MPV04	85.00	20.16	96.00	28	5	11	2	6	29,900.00	
20310510145	S800	2	MPV03	114.00	24.10	105.00	32	8	18	4	9	40,900.00	H★
20310510170	S900	2	MPV03	145.20	29.70	118.00	36	10	24	4	11	48,500.00	
20310510185	S1000	2	MPV03	176.86	40.20	122.00	40	13	31	6	14	77,200.00	
20310510205	S1200	2	MPV03	232.00	52.80	141.00	48	18	43	8	19	90,900.00	
20310510190	S1000C	2.5	MPV13	180.68	41.00	122.00	40	13	31	6	14	84,200.00	
20310510210	S1200C	2.5	MPV13	257.93	58.50	141.00	48	18	43	8	19	102,000.00	

\*\* ราคารวมสารกรองทราย / Included Sand Media

หมายเหตุ : ราคายังไม่รวมภาษี 7% บริษัทฯ ขอสงวนสิทธิ์ในการเปลี่ยนแปลงราคาโดยไม่ต้องแจ้งให้ทราบล่วงหน้า  
 Remarks : Excluded VAT 7%. The Company reserves the right to change the prices without announcement.



# Commercial Filter

## ABLE TO WORK AND RESIST EXTREME WEATHER CONDITIONS

The filter tank is manufactured of durable, non-corrosive fiberglass and resin, with automatic bobbin winding technology, UV resistant composites, which allow the filter to operate under extreme weather conditions.

### Multi-layer construction (from inner to outer):



- ① ISO or VE gelcoat barrier, corrosion resistant
- ② Woven roving fibers with ISO polyester resin, water proofing
- ③ Woven roving with high content of fiberglass, structural strength
- ④ Continuous outer filament winding with ISO resin, reinforced to withstand pressure
- ⑤ PU surface coating, UV resistant and dirt protection



computer controlled filament winding

Non-Corrosive	UV Resistance	Chemical Resistance	Nil Maintenance	Non-Electrical Conductive	Long Service Life	Low ratio of Thermal Expansion	Light and Easy Handling

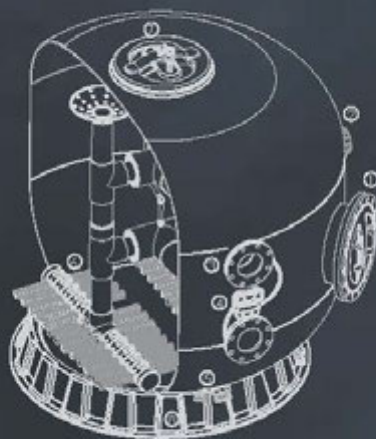

### Components :

- ① **Manhole** Lateral manhole for easy access to internal system maintenance and service
- ② **Sight Glass** Allows great observation on media status and backwash effect
- ③ **Flange** Heavy duty FRP flange connections in either ANSI or DIN standard
- ④ **Manometer** High quality pressure gauge to monitor the pressure inside the filter tank
- ⑤ **Union Drain** A quick discharge point for water and filter media
- ⑥ **Lateral System** Constructed of ABS+PP material with rigid structure and 0.4mm slot
- ⑦ **Air Vent Valve** Release air bubble valve in the filtration system
- ⑧ **Base** Flat base for increase the stability



# “EMAUX” NL Series Commercial Sand Filters (Without Valves)

For competition swimming pools, aquatic parks, aquariums, commercial spas, fountains and water treatment plants

### EXCELLENT PERFORMANCE WITH DEEP SAND BED!

The filter tank is manufactured of durable, non-corrosive fiberglass and resin, with automatic bobbin winding technology UV resistant composites, which allow the filter to operate under extreme weather conditions.

### APPLICATION SUGGESTIONS

- Competition swimming pool
- Aquatic park and aquarium
- Commercial spa, fountain
- Water treatment plant

### PRODUCT FEATURES

1. Multi-construction layers: non-corrosive & chemical protective
2. UV resistance, suitable for operation under prolonged sunlight
3. High filtration standard with deep bed sand
4. Bobbin wound fiberglass reinforced with polyester resin
5. Available in laterals or nozzle plate system for air scouring capabilities
6. Optional accessories including sight glass, manhole, union drain & air purge

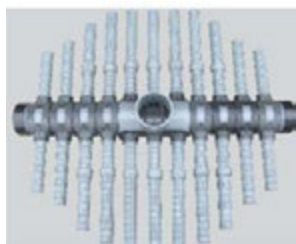

### With Laterals System:

Model	Vol. (m <sup>3</sup> )	Filter Area (m <sup>2</sup> )	Flange Connections		Max Flow Rate		Sand Weight (kg)	
			GB(mm)	ANSI	lpm	m <sup>3</sup> /h	0.5-0.8mm	1-2mm
NL1200	1.17	1.13	80	3"	942	56.5	900	300
NL1400	1.64	1.54	100	4"	1283	77	1350	450
NL1600	2.48	2.01	100	4"	1675	100.5	2300	700
NL1800	4.02	2.52	150	6"	2100	126	2900	900
NL2000	4.61	2.97	150	6"	2475	148.5	4000	1100
NL2300	8.09	4.34	200	8"	3617	217	6000	1600
NL2500	10.00	4.89	200	8"	4075	244.5	6700	1800



### Design Filtration Velocity

50m<sup>3</sup> / h / m<sup>2</sup>

### Filtration System

Laterals / Nozzles

### Max Temperature

43°C (109°F)

### Max Operating

Pressure

### Suggested Size of Media

0.5 – 0.8 mm

36 psi (2.5 bar)

1- 2 mm

58 psi (4.0 bar)

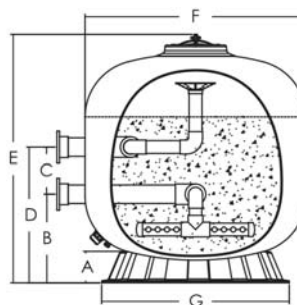

### Product Dimensions:

Model	A mm	B mm	C mm	D mm	E mm	F mm	G mm
NL1200	170	565	350	915	1410	1200	1000
NL1400	190	565	350	915	1570	1400	1220
NL1600	200	650	350	1000	1740	1620	1365
NL1800	220	690	415	1105	2040	1790	1630
NL2000	220	770	415	1185	2210	1945	1630
NL2300	230	950	550	1500	2510	2375	1800
NL2500	230	1050	550	1600	2670	2495	1800



**Laterals System / Working Pressure 2.5 Bar**

Code	Model	Volume (m <sup>3</sup> )	Filter Area (m <sup>2</sup> )	In&Outlet (inches)	Flowrate (gpm)	Flowrate (m <sup>3</sup> /h)	Height (cm)	Sand(kg) 0.5-0.8mm	Gravel (kg) 1-2mm	Retail Price	Code✖
20300510005	NL1200-LS-2.5 ✖	1.17	1.11	3	242.88	55.20	141.00	900	300	126,000.00	I
20300510045	NL1400-LS-2.5 ✖	1.64	1.54	4	337.92	76.80	157.00	1350	450	172,000.00	
20300510080	NL1600-LS-2.5 ✖	2.48	2.06	4	448.80	102.00	174.00	2300	700	202,000.00	
20300510120	NL1800-LS-2.5 ✖	4.02	2.52	6	549.12	124.80	204.00	2900	900	290,000.00	
20300510160	NL2000-LS-2.5 ✖	5.07	2.97	6	646.80	147.00	221.00	4000	1100	340,000.00	
20300510200	NL2300-LS-2.5 ✖	8.09	4.43	8	963.60	219.00	251.00	6000	1600	กรุณาติดต่อเจ้าหน้าที่ / Please Check with Sales Assistance	
20300510240	NL2500-LS-2.5 ✖	10.00	4.89	8	1056.00	240.00	267.00	6700	1800		

**Laterals System / Working Pressure 4.0 Bar**

Code	Model	Volume (m <sup>3</sup> )	Filter Area (m <sup>2</sup> )	In&Outlet (inches)	Flowrate (gpm)	Flowrate (m <sup>3</sup> /h)	Height (cm)	Sand(kg) 0.5-0.8mm	Gravel (kg) 1-2mm	Retail Price	Code✖
20300510010	NL1200-LS-4 ✖	1.17	1.11	3	242.88	55.20	141.00	900	300	155,000.00	I
20300510050	NL1400-LS-4 ✖	1.64	1.54	4	337.92	76.80	157.00	1350	450	189,000.00	
20300510085	NL1600-LS-4 ✖	2.48	2.06	4	448.80	102.00	174.00	2300	700	239,000.00	
20300510125	NL1800-LS-4 ✖	4.02	2.52	6	549.12	124.80	204.00	2900	900	349,000.00	
20300510165	NL2000-LS-4 ✖	5.07	2.97	6	646.80	147.00	221.00	4000	1100	390,000.00	
20300510205	NL2300-LS-4 ✖	8.09	4.43	8	963.60	219.00	251.00	6000	1600	กรุณาติดต่อเจ้าหน้าที่ / Please Check with Sales Assistance	
20300510245	NL2500-LS-4 ✖	10.00	4.89	8	1056.00	240.00	267.00	6700	1800		

✖✖ ราคาไม่รวมสารกรองทราย / Included Sand Media

✖ สินค้าไม่มีสต็อก กรุณาสั่งซื้อล่วงหน้า / No Stock, Delivery Time : 60 - 90 Days

หมายเหตุ : ราคายังไม่รวมภาษี 7% บริษัทฯ ขอสงวนสิทธิ์ในการเปลี่ยนแปลงราคาโดยไม่ต้องแจ้งให้ทราบล่วงหน้า  
 Remarks : Excluded VAT 7%. The Company reserves the right to change the prices without announcement.



# “EMAUX” Butterfly Valve Systems For Commercial Sand Filters

## FEATURES

1. Made with anti-corrosive material
2. Applies with flange design which enables easy installation and disassembly
3. Suitable for commercial heavy duty usage.

## 5 Way Butterfly Valve

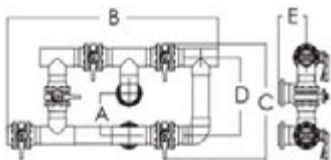
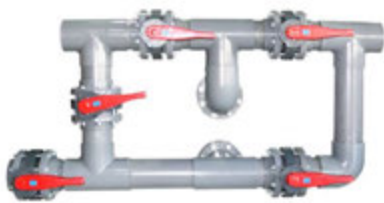

5 Way Butterfly Valve NBV30-NBV80

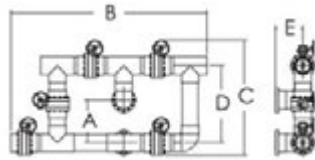
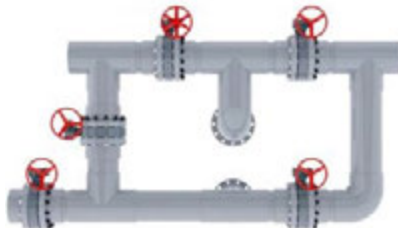

5 Way Butterfly Valve BVGT100- BVGT120

### Tank Material

Anti-Corrosive

### Max Working Pressure

250kPa/36psi/2.5bar

### Factory Testing Pressure

400kPa/58psi/4.0bar

### Max Temperature

40°C (109°F)

## Product Information

Model	Valve Connection		A (mm)	B (mm)	C (mm)	D (mm)	E (mm)
	GB(mm)	ANSI					
NBV30-5	90	3"	350	1395	889	552	172
NBV40-5	110	4"	350	1521	963	614	210
NBV60-5	160	6"	415	2039	1228	775	287
NBV80-5	200	8"	550	2832	1500	1015	376
BVGT100-5	250	10"	710	3374	1913	1286	472
BVGT120-5	315	12"	710	3692	2106	1423	552



Code	Model	Description	Size	Retail Price	Code✘
2350333900	NBV30-5 ✘	5-Way Valve System In/Outlet Butterfly Valve	3"	38,000.00	B
22100510040	NBV40-5 ✘		4"	49,000.00	
22100510045	NBV60-5 ✘		6"	108,000.00	
22100510050	NBV80-5 ✘		8"	187,000.00	
22100510055	BVGT100-5 ✘		10"	กรุณาติดต่อเจ้าหน้าที่ / Please Check with Sales Assistance	
22100510060	BVGT120-5 ✘		12"		

✘ สินค้าไม่มีสต็อก กรุณาสั่งซื้อล่วงหน้า / No Stock, Delivery Time : 60 - 90 Days

หมายเหตุ : ราคายังไม่รวมภาษี 7% บริษัทฯ ขอสงวนสิทธิ์ในการเปลี่ยนแปลงราคาโดยไม่ต้องแจ้งให้ทราบล่วงหน้า  
Remarks : Excluded VAT 7%. The Company reserves the right to change the prices without announcement.





# “EMAUX” LF Series Biological Filters For Koi Fish System Complete Set with Multiport Valve & Filter Media

**Tank Material**

Bobbin-wound reinforced fiberglass tank

**Max Operating Pressure**

36psi (2.5bar)

**Max Temperature**

43°C (109°F)

**ABOUT BIOLOGICAL FILTRATION**

Biological filtration takes place when the beneficial bacterial breed inside the special filtration media in the tank. These bacteria efficiently convert the ammonia to nitrites, and then to less harmful nitrates.



**ABOUT PHYSICAL FILTRATION**

When water passes through the filter tank, large particles are trapped by the biological filter media. The small particles are also blocked by the linked biological filter media. After certain period of time, those particles accumulate and the pressure inside the tank increases. The particles can be cleared and the pressure released by backwashing the tank.

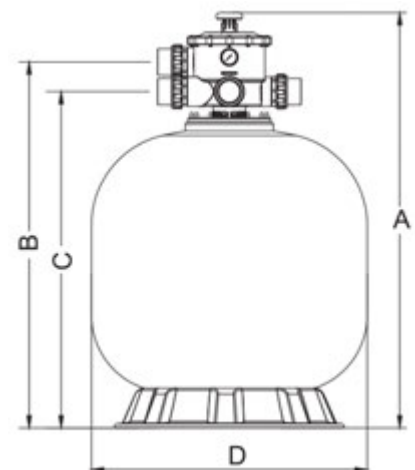
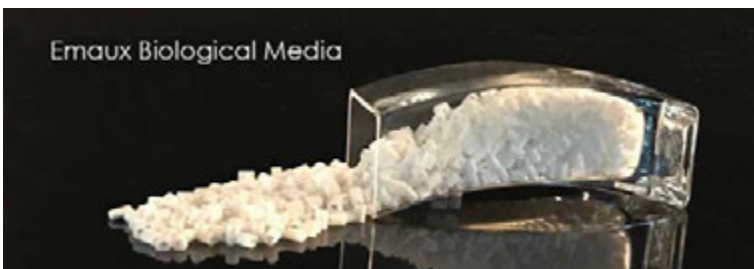

Model	A mm	B mm	C mm	D mm
LF700	1126	1030	933	723
LF800	1234	1155	1058	800
LF900	1334	1242	1145	900



Installation Diagram

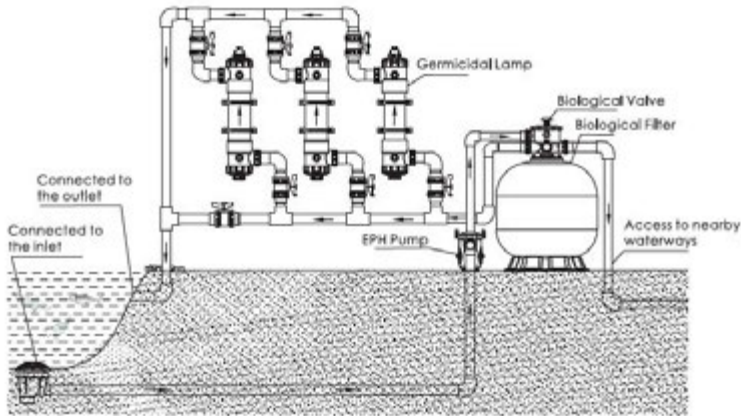

For 1 m<sup>3</sup> of water, it will be better that to farm 1.5 KG of fish. This is a general formula for Koi fish.

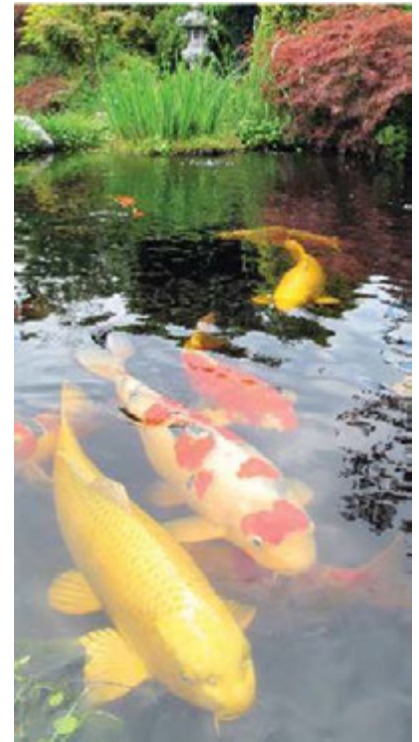

EXCLUSIVE FILTRATION AND BACKWASH RESULT

Biological Filtration System is environmentally friendly with good filtration and backwash performance. It solves the traditional problems of sand agglomeration in the tank. Designed not only with a modern appearance, but it also significantly reduces the size of the filtration system compared to traditional installations.

Code	Model	MV (inches)	MPV Model)	Flowrate (m <sup>3</sup> /h)	Volume of water (m <sup>3</sup> )	Recommended Pump (If head loss is less than 14 m.)	Included Biological Media (kg)	Retail Price	Code✘
20350510020	LF-700	2.5	MPV17	14	30	SB10 or SB20	30	56,000.00	
20350510025	LF-800	2.5	MPV17	18	40	EPH200	45	67,000.00	B ★
20350510030	LF-900	2.5	MPV17	21	50	EPH300	60	79,000.00	

✘ ราคารวมสารกรอง / Included Filter Media

หมายเหตุ : ราคายังไม่รวมภาษี 7% บริษัทฯ ขอสงวนสิทธิ์ในการเปลี่ยนแปลงราคาโดยไม่ต้องแจ้งให้ทราบล่วงหน้า  
 Remarks : Excluded VAT 7%. The Company reserves the right to change the prices without announcement.



# “EMAUX” CF Series Cartridge Filters

## FEATURES

- Compact and lightweight
- UV resistant tank
- Heavy duty ring-lock lid allows easy cleaning and replacement of the cartridge element
- Screw type air bleeder for easy removal of trapped air inside the filter tank
- High-quality oil-filled pressure gauge for easy inspection of the operation pressure
- Application to domestic swimming pool & spa
- Maximum Working Pressure 250kPa /36psi /2.5bar
- Maximum Water Temperature 40°C (100°F)



## CF SERIES FILTER IS EQUIPPED WITH

1. Universal standard of union connection
2. Pressure gauge
3. Cartridge filter element

## Product Information:

Model	Filter Area (m <sup>2</sup> )	Valve Connections	Max Flow Rate	A mm	B mm	C mm
CF25	2.25	1.5" / 50mm	92lpm 5.5m <sup>3</sup> /h	445	387	225
CF50	4.63	1.5" / 50mm	190lpm 11.4m <sup>3</sup> /h	625	567	225
CF75	7.00	1.5" / 50mm	283lpm 17.0m <sup>3</sup> /h	805	747	225
CF100	9.40	2.0" / 63mm	382lpm 22.9m <sup>3</sup> /h	985	927	225
CF150	13.72	2.0" / 63mm	555lpm 33.4m <sup>3</sup> /h	1165	1107	225
CF200	16.82	2.0" / 63mm	680lpm 40.9m <sup>3</sup> /h	1345	1287	225

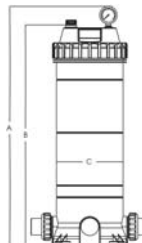

### Tank Material

UV Resistant Plastic

### Max Operating Pressure

36 psi / 2.5 bar

### Max Temperature

40°C (104°F)

Code	Model	In/Outlet (inches)	Sq.Ft.	Flowrate (gpm)	Flowrate (m <sup>3</sup> /h)	Height (cm)	Width (cm)	Retail Price	Code✳	
20510510005	CF25	1.5	25	25	5.5	44.50	22.50	7,200.00	H★	
20510510010	CF50		50	50	11.4	62.50		9,600.00		
20510510015	CF75		75	75	17.0	80.50		11,900.00		
20510510020	CF100		100	100	22.9	98.50		13,200.00		
20510510025	CF150		2	150	147	33.4		116.50		15,900.00
20510510030	CF200		200	180	40.9	134.50		18,200.00		

หมายเหตุ : ราคายังไม่รวมภาษี 7% บริษัทฯ ขอสงวนสิทธิ์ในการเปลี่ยนแปลงราคาโดยไม่ต้องแจ้งให้ทราบล่วงหน้า

Remarks : Excluded VAT 7%. The Company reserves the right to change the prices without announcement.



# “EMAUX” ICF Series Galaxy Single-Element Cartridge Filters

**DELIVER OPTIMAL SPARKLING CLEAR WATER**  
For residential and semi-commercial pools

Galaxy Single-Element Cartridge Filter is built with high-strength and UV-resistant material to prolong the product life. The compact and low height design is suitable for any pool especially with limited system setup space. The extensive dirt-catching capability of the filter element makes this filter highly efficient. A reliable choice for crystal clear water.

**FEATURES**

- Eco-friendly
- User friendly
- Trouble-free maintenance

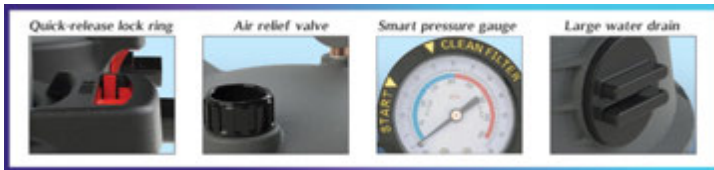

Model	G mm	H mm	Micron $\mu$ m	Fold Number
ICF100-CE	497	Ø267	15	137
ICF150-CE	590	Ø267	15	172
ICF200-CE	717	Ø267	15	187

## Product Information:

Model	Filter Area	Max Flow Rate	A mm	B mm	C mm	D mm	E mm	F mm
ICF100	100 sqft 9.29m <sup>2</sup>	379 lpm 22.7m <sup>3</sup> /h	825	444.5	588	304	335	91
ICF150	150 sqft 13.94m <sup>2</sup>	455 lpm 27.3m <sup>3</sup> /h	910	444.5	588	304	335	91
ICF200	200 sqft 18.58m <sup>2</sup>	455 lpm 27.3m <sup>3</sup> /h	1033	444.5	588	304	335	91

Code	Model	In/Outlet (inches)	Filter Area (m <sup>2</sup> )	Flowrate (gpm)	Flowrate (m <sup>3</sup> /h)	Height (cm)	Width (cm)	Retail Price	Code✳
20510510065	ICF100	2"	9.29	100	22.7	82.5	33.5	19,000.00	I ★
20510510070	ICF150	2"	13.94	120	27.3	91.0	33.5	21,000.00	
20510510075	ICF200	2"	18.58	120	27.3	103.3	33.5	23,000.00	

หมายเหตุ : ราคายังไม่รวมภาษี 7% บริษัทฯ ขอสงวนสิทธิ์ในการเปลี่ยนแปลงราคาโดยไม่ต้องแจ้งให้ทราบล่วงหน้า  
Remarks : Excluded VAT 7%. The Company reserves the right to change the prices without announcement.



# “EMAUX” ICF Series Galaxy Multi-Element Cartridge Filters

## DELIVER OPTIMAL SPARKLING CLEAR WATER

### For residential and semi-commercial pools

The Galaxy Multi-Element Cartridge Filter is designed to be the best in its class. Adopting the latest technology and constructed with non-corroding and durable materials, the Emaux Galaxy Cartridge Filter has a bigger filter area than most models on the market. The high capacity tank partnered with the advanced multi-element raises hydraulic dirt-catching performance to new levels. Due to being eco and user friendly, it's the ideal choice for residential and commercial pools.



### FEATURES

- Eco-friendly
- User friendly
- Trouble-free maintenance

Model	No. of Element	H mm	I mm	Micron $\mu$ m	Fold Number
ICF230-CE	4	441	Ø178	15	156
ICF330-CE	4	498	Ø178	15	198
ICF430-CE	4	647	Ø178	15	197
ICF530-CE	4	835	Ø178	15	187
ICF680-CE	8	485	Ø178	15	209

## Product Information:

Model	Filter Area	Max Flow Rate	A mm	B mm	C mm	D mm	E mm	F mm	G mm
ICF230	230 sqft 21.37m <sup>2</sup>	327 lpm 19.6m <sup>3</sup> /h	829	648	556	504	462	317.5	444.5
ICF330	330 sqft 30.73m <sup>2</sup>	468 lpm 28.1m <sup>3</sup> /h	886	648	556	504	462	317.5	444.5
ICF430	430 sqft 39.97m <sup>2</sup>	575 lpm 34.5m <sup>3</sup> /h	1035	648	556	504	462	317.5	444.5
ICF530	530 sqft 49.19m <sup>2</sup>	575 lpm 34.5m <sup>3</sup> /h	1223	648	556	504	462	317.5	444.5
ICF680	680 sqft 63.13m <sup>2</sup>	575 lpm 34.5m <sup>3</sup> /h	1362	648	556	504	462	317.5	444.5

Code	Model	In/Outlet (inches)	Filter Area (m <sup>2</sup> )	Flowrate (gpm)	Flowrate (m <sup>3</sup> /h)	Height (cm)	Width (cm)	Retail Price	Code✳
20510510080	ICF230	2"	21.37	86	19.6	82.9	46.2	42,000.00	I ★
20510510085	ICF330	2"	30.73	124	28.1	88.6	46.2	46,000.00	
20510510090	ICF430	2"	39.97	152	34.5	103.5	46.2	48,000.00	
20510510095	ICF530	2"	49.19	152	34.5	122.3	46.2	50,000.00	
20510510100	ICF680	2"	63.13	152	34.5	136.2	46.2	57,000.00	

หมายเหตุ : ราคายังไม่รวมภาษี 7% บริษัทฯ ขอสงวนสิทธิ์ในการเปลี่ยนแปลงราคาโดยไม่ต้องแจ้งให้ทราบล่วงหน้า

Remarks : Excluded VAT 7%. The Company reserves the right to change the prices without announcement.



# “PRAHER” Aquastar Easy II Series Automatic Multiport Valve

## FEATURES

- Valve body in ABS
- 100-240 VAC or 150-300 VDC
- Protection class IP65
- UV-resistant
- Emergency handle
- Pressure sensor for permanent monitoring or Time Controller
- Winter position for protection of valve gaskets
- Optical position indicator



## TECHNICAL DATAS

Aquastar	
Voltage:	24 V AC/DC
Protection:	IP65
Frequency:	50/60 Hz /DC
Rated operating current:	100mA at 230V AC 200mA at 110V AC
Max. Power:	20VA
Environmental conditions:	0-40°C, 0-95%RH not condensing
Max static pressure:	0,3 Bar
Max water column:	3 m
Relais Pumpe:	8A at cosp=1
Relais Kugelhahn:	8A at cosp=1
Multifunktionsrelais:	3A at cosp=1
Possible positions of Aquastar EasyII	Filter, Backwash, Rinse, Recirculate, Waste

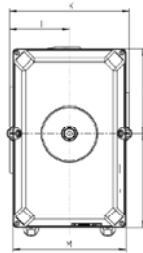

Praher Plastics 6-Way Valve	
Body material:	1,5" - 2" ABS / ASA-GF 3" ASA-GF
Seals:	TPE + NBR
Operating pressure:	1,5" - 2" ABS: 3,5 Bar (20°C) ASA-GF: 6,5 Bar (20°C)
Maximum pressure when the valve plate is lifting	0,3 Bar
The Aquastar easyII is fully assembled only available in combination with an SM-valve. But it can also be mounted on TM-valves.	

	1 1/4" SM	1 1/2" TM	2" SM
A	99,5	X	110
B	90	X	114
C	29,5	31,5	38
D	48	47	60
E	61,5	59,5	81
F	163,5	160	210
G	295	291	339
H	39	42,5	36
I	87,5	90	114
K	175	180	228
L	125	125	125
M	165	165	165
N	140	140	140
O	18,5	18,5	26
P	X	62,5	X

Dimensionen in mm

Code	Model	Size	Type	Description	Retail Price	Code✳
20611600070	AquaStar Easy II-1.5 ✳	1.5"	Side Mount	Automatic multiport valve	กรุณาติดต่อเจ้าหน้าที่ / Please Check with Sales Assistance	
20611600075	AquaStar Easy II-2 ✳	2"				

✳ สินค้าไม่มีสต็อก กรุณาลังซื้อล่วงหน้า / No Stock, Delivery Time : 60 - 90 Days

หมายเหตุ : ราคายังไม่รวมภาษี 7% บริษัทฯ ขอสงวนสิทธิ์ในการเปลี่ยนแปลงราคาโดยไม่ต้องแจ้งให้ทราบล่วงหน้า  
Remarks : Excluded VAT 7%. The Company reserves the right to change the prices without announcement.



# “EMAUX” Multiport Valves (1)

## 1.5 inch 6-Way Top Mount Valve (MPV01)

For Top Mount Fiberglass and Plastic Filters / Emaux V, P Series Filters

**Connection**

Clamp Type

**Factory Testing Pressure**

700kPa/101psi/7bar

**Flow Rate**

17m<sup>3</sup>/h at 400kPa/58psi/4bar

**Max Working Pressure**

400kPa/58psi/4bar

**Max Temperature**

50°C (122°F)

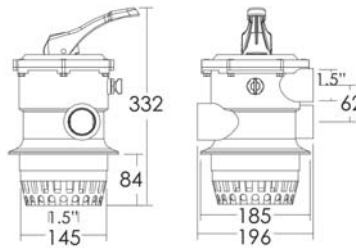

Code	Model	Colour	Type	Size	Description	Use with Filter	Retail Price	Code✘
20600510010	MPV01-V-V	Black	Top Mount (Clamp)	1.5"	Valve only	V & TMG Series	3,800.00	B★

## 2 inch 6-Way Top Mount Valve (MPV02)

For Top Mount Fiberglass Filters / Emaux V, TMG Series Filters

**Connection**

Bolt Type

**Factory Testing Pressure**

500kPa/72psi/5bar

**Flow Rate**

27m<sup>3</sup>/h at 400kPa/58psi/4bar

**Max Working Pressure**

400kPa/58psi/4bar

**Max Temperature**

50°C (122°F)

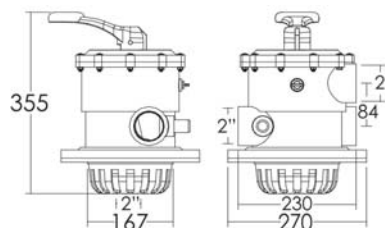

Code	Model	Colour	Type	Size	Description	Use with Filter	Retail Price	Code✘
20600510030	MPV02-V-V	Black	Top Mount (Bolts Type)	2"	Valve only	V & TMG Series	5,100.00	B★

หมายเหตุ : ราคายังไม่รวมภาษี 7% บริษัทฯ ขอสงวนสิทธิ์ในการเปลี่ยนแปลงราคาโดยไม่ต้องแจ้งให้ทราบล่วงหน้า

Remarks : Excluded VAT 7%. The Company reserves the right to change the prices without announcement.



## “EMAUX” Multiport Valves (2)

### 1.5 inch 6-Way Top Mount Valve (with Turn-Lock Lid) (MPV07)

For Top Mount Fiberglass and Plastic Filters / Emaux MFV Series, T Series, TMG Series 500/650 Filters. Turn-Lock Lid allow Tool-Free Servicing

**Connection**

Clamp Type

**Max Working Pressure**

400kPa/58psi/4bar

**Factory Testing Pressure**

700kPa/101psi/7bar

**Max Temperature**

50°C (122°F)

**Flow Rate**

17m<sup>3</sup>/h at 400kPa/58psi/4bar

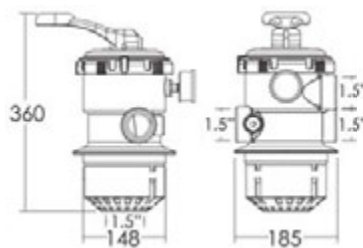

Code	Model	Colour	Type	Size	Description	Use with Filter	Retail Price	Code✘
20600510025	MPV07- MFV-V	Black	Top Mount (Clamp Type)	1.5"	Valve only	MFV & TMG Series	3,800.00	B★

### 2 inch 6-Way Top Mount Valve (with Turn-Lock Lid) (MPV08)

For Top Mount Fiberglass and Plastic Filters / Emaux V650(PB), MFV Series Filters. Turn-Lock Lid allow Tool-Free Servicing

**Connection**

Bolt Type

**Max Working Pressure**

400kPa/58psi/4bar

**Factory Testing Pressure**

500kPa/72psi/5bar

**Max Temperature**

50°C (122°F)

**Flow Rate**

27m<sup>3</sup>/h at 400kPa/58psi/4bar

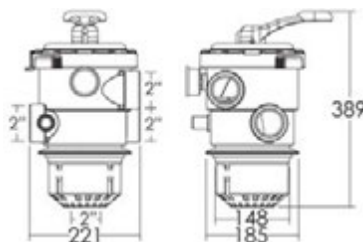

Code	Model	Colour	Type	Size	Description	Use with Filter	Retail Price	Code✘
20600510040	MPV08- MFV-V	Black	Top Mount (Clamp Type)	2"	Valve only	MFV & TMG Series	5,100.00	B★

หมายเหตุ : ราคายังไม่รวมภาษี 7% บริษัทฯ ขอสงวนสิทธิ์ในการเปลี่ยนแปลงราคาโดยไม่ต้องแจ้งให้ทราบล่วงหน้า  
Remarks : Excluded VAT 7%. The Company reserves the right to change the prices without announcement.





# “EMAUX” Multiport Valves (3)

## 1.5 inch 6-Way Side Mount Valve (MPV03)

For Side Mount Filters / Emaux MAX, SP, S, SR Series Filters

<b>Connection</b>	<b>Max Working Pressure</b>
Union Connection	400kPa/58psi/4bar
<b>Factory Testing Pressure</b>	<b>Max Temperature</b>
700kPa/101psi/7bar	50°C (122°F)
<b>Flow Rate</b>	
17m <sup>3</sup> /h at 400kPa/58psi/4bar	

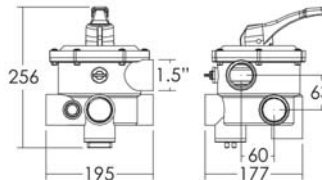

Code	Model	Colour	Type	Size	Description	Use with Filter	Retail Price	Code✘
20600510060	MPV03-V	Black	Side Mount	1.5"	Valve only	S & MFS & SMG Series	3,800.00	B ★
20610510035	MPV03-C				Complete set with piping & unions		5,100.00	

## 2 inch 6-Way Side Mount Valve (MPV04)

For Side Mount Fiberglass and Plastic Filters / Emaux MAX, S Series Filters

<b>Connection</b>	<b>Max Working Pressure</b>
Clamp Type	400kPa/58psi/4bar
<b>Factory Testing Pressure</b>	<b>Max Temperature</b>
500kPa/101psi/7bar	50°C (122°F)
<b>Flow Rate</b>	
27m <sup>3</sup> /h at 400kPa/58psi/4bar	

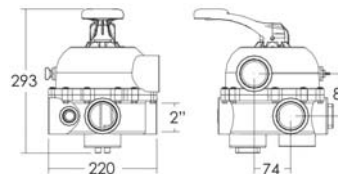

Code	Model	Colour	Type	Size	Description	Use with Filter	Retail Price	Code✘
20600510065	MPV04-V	Black	Side Mount	2"	Valve only	S & MFS & SMG Series	5,100.00	B ★
20610510040	MPV04-C				Complete set with piping & unions		6,400.00	

## 2.5 inch Side Mount Multiport Valve (MPV13)

For Side Mount Fiberglass & Deep Bed Filters / Emaux S & SDB Series Filters

<b>Connection</b>	<b>Max Working Pressure</b>
Flange Type	400kPa/58psi/4bar
<b>Factory Testing Pressure</b>	<b>Max Temperature</b>
500kPa/72psi/5bar	50°C (122°F)
<b>Flow Rate</b>	
52m <sup>3</sup> /h at 400kPa/58psi/4bar	

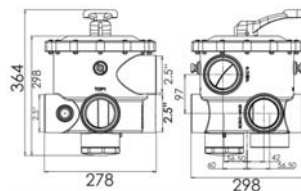

Code	Model	Colour	Type	Size	Description	Use with Filter	Retail Price	Code✘
20600510050	MPV13-V	Black	Side Mount	2.5"	Valve only	S Series	7,700.00	B ★
20600510025	MPV13-C				Complete set with piping & unions		9,900.00	

หมายเหตุ : ราคายังไม่รวมภาษี 7% บริษัทฯ ขอสงวนสิทธิ์ในการเปลี่ยนแปลงราคาโดยไม่ต้องแจ้งให้ทราบล่วงหน้า

Remarks : Excluded VAT 7%. The Company reserves the right to change the prices without announcement.



# “EMAUX” Multiport Valves (4)

## Commercial 3 inch 6-Way Side Mount Valve (MPV14)

For Side Mount Commercial Filters / Emaux S, NL, K Series Filters

<b>Connection</b>	<b>Max Working Pressure</b>
Flange Type	400kPa/58psi/4bar
<b>Factory Testing Pressure</b>	<b>Max Temperature</b>
500kPa/72psi/5bar	50°C (122°F)
<b>Flow Rate</b>	
52m <sup>3</sup> /h at 400kPa/58psi/4bar	

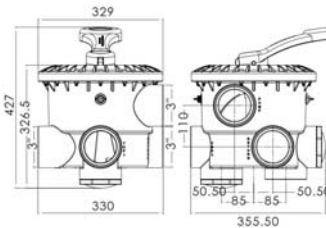

Code	Model	Colour	Type	Size	Description	Retail Price	Code✘
20600510055	MPV14-V✘	Black	Side Mount	3"	Valve only	25,000.00	B★

## Commercial 4 inch 6-Way Side Mount Valve (MPV15)

For Side Mount Commercial Filters / Emaux NL, K Series Filters

<b>Connection</b>	<b>Max Working Pressure</b>
Flange Type	400kPa/58psi/4bar
<b>Factory Testing Pressure</b>	<b>Max Temperature</b>
500kPa/72psi/5bar	50°C (122°F)
<b>Flow Rate</b>	
108m <sup>3</sup> /h at 400kPa/58psi/4bar	

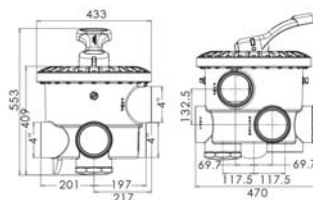

Code	Model	Colour	Type	Size	Description	Retail Price	Code✘
20610510030	MPV15-V✘	Black	Side Mount	4"	Valve only	32,000.00	B★

## 2.5 inch Top Mount Multiport Valve (MPV17)

For Emaux LF Series Biological Filters



Code	Model	Colour	Type	Size	Description	Use with Filter	Retail Price	Code✘
20610510045	MPV17-LF700✘	Black	Top Mount	2.5"	Center Pipe & Collector System	LF700	11,800.00	B★
20610510050	MPV17-LF800✘	Black	Top Mount	2.5"		LF800	11,800.00	
20610510055	MPV17-LF900✘	Black	Top Mount	2.5"		LF900	11,800.00	

✘ สินค้าไม่มีสต็อก กรุณาสั่งซื้อล่วงหน้า / No Stock, Delivery Time : 60 - 90 Days

หมายเหตุ : ราคายังไม่รวมภาษี 7% บริษัทฯ ขอสงวนสิทธิ์ในการเปลี่ยนแปลงราคาโดยไม่ต้องแจ้งให้ทราบล่วงหน้า  
Remarks : Excluded VAT 7%. The Company reserves the right to change the prices without announcement.



# “EMAUX” Multiport Valves (5)

## 1 inch 6-Way Top Mount Valve (MPV06)

For Emaux HD Series Deep Bed Filter

**Connection**

Thread Type

**Max Working Pressure**

700kPa/101psi/7bar

**Factory Testing Pressure**

1500kPa/217psi/15bar

**Max Temperature**

50°C (122°F)

**Flow Rate**

5m<sup>3</sup>/h at 400kPa/58psi/4bar

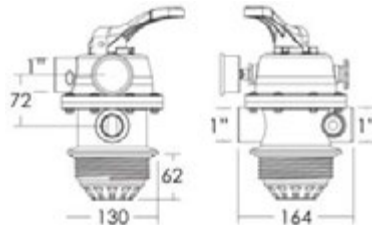

Code	Model	Colour	Type	Size	Description	Use with Filter	Retail Price	Code✳
20600510005	MPV06-HD-V	Black	Top Mount (Thread Type)	1”	Valve only	HD Series	3,800.00	B★

### POOLSPA Unions Spare Parts

POOLSPA CODES	PART NO.	DESCRIPTIONS	RETAIL PRICE 2023
20651610005	PS-US15-B	ยูเนียน 1.5" Union set (3 pcs) c/w O-ring, Black Colour	570.00
20651610010	PS-US20-B	ยูเนียน 2" Union set (3 pcs) c/w O-ring, Black Colour	610.00
20651610015	PS-US15-W	ยูเนียน 1.5" Union set (3 pcs) c/w O-ring, White Colour	570.00
20651610020	PS-US20-W	ยูเนียน 2" Union set (3 pcs) c/w O-ring, White Colour	610.00



### EMAUX Unions Spare Parts

KEY NO.	POOLSPA CODES	PART NO.	DESCRIPTIONS	RETAIL PRICE 2023
3	20651610025	89280102B	1.5" union set (Black) with O-ring	550.00
3	20651610030	89280103B	2.0" Union (Black) with O-ring	590.00
3	20651610035	89280102W	1.5" union set (White) with O-ring	550.00
3	20651610040	89280103W	2" union set (White) with O-ring	590.00



### EMAUX Union With Sight Glass For Top Mount Sand Filter Spare Parts

KEY NO.	POOLSPA CODES	PART NO.	DESCRIPTIONS	PIECE (S) REQUIRED	RETAIL PRICE 2023
2	20650510005	89280101	1.5" Union with Sight Glass and O-Ring (Black/ White colour)	1	590.00



### EMAUX Oil Pressure Gauge For Top Mount Sand Filter Spare Parts

KEY NO.	POOLSPA CODES	PART NO.	DESCRIPTIONS	PIECE (S) REQUIRED	RETAIL PRICE 2023
2	20320511020	06011029	Maximum 40PSI Indication, Stainless Steel Casing	1	990.00



### EMAUX Oil Pressure Gauge For Side Mount Sand Filter Spare Parts

KEY NO.	POOLSPA CODES	PART NO.	DESCRIPTIONS	PIECE (S) REQUIRED	RETAIL PRICE 2023
2	20320511025	06011032	Maximum 40PSI Indication, Stainless Steel Casing	1	990.00



หมายเหตุ : ราคายังไม่รวมภาษี 7% บริษัทฯ ขอสงวนสิทธิ์ในการเปลี่ยนแปลงราคาโดยไม่ต้องแจ้งให้ทราบล่วงหน้า

Remarks : Excluded VAT 7%. The Company reserves the right to change the prices without announcement.



“HAYWARD” D.E. & Sand Filters



Progrid Series D.E. Filters Complete Set With Multiport Valve

Code	Model	MV (inches)	Sq.Ft.	Flowrate (gpm)	Flowrate (m <sup>3</sup> /h)	Height (cm)	Width (cm)	Retail Price	Code ✖
20410800010	DE3620	2	36	72	16.36	88.00	61.00	65,600.00	I
20410800015	DE4820	2	48	96	21.81	103.00	61.00	73,200.00	
20410800020	DE6020	2	60	120	27.27	118.00	61.00	78,300.00	
20410800025	DE7220	2	72	144	32.70	133.00	61.00	95,950.00	



Pro Series Top Mount Sand Filters Complete Set With Multiport Valve

Code	Model	MV (inches)	Flowrate (gpm)	Flowrate (m <sup>3</sup> /h)	Height (cm)	Width (inches)	Sand (50kgs /bag)	Zelbrite (15kgs/ bag)	EcoClear (25kgs/bag)		Retail Price	Code ✖
									Coare	Fine		
20310800005	S180T	1.5	35	7.95	98.00	18	2	5	1	2	24,850.00	I
20310800010	S210T	1.5	44	10.00	96.50	21	2	5	1	2	27,400.00	
20310800015	S244T	2	62	14.09	106.70	24	3	8	1	3	33,150.00	
20310800020	S270T	2	74	16.81	107.50	27	4	13	2	4	35,650.00	
20310800025	S310T2	2	98	22.27	121.90	31	5	13	2	6	52,950.00	

✖✖ ราคารวมสารกรองทราย / Included Sand Media



Pro Series Side Mount Sand Filters Complete Set With Multiport Valve

Code	Model	MV (inches)	Flowrate (gpm)	Flowrate (m <sup>3</sup> /h)	Height (cm)	Width (inches)	Sand (50kgs /bag)	Zelbrite (15kgs/ bag)	EcoClear (25kgs/bag)		Retail Price	Code ✖
									Coare	Fine		
20310800030	S311SX	2	99	22.50	98.00	31	5	13	2	6	64,500.00	I
20310800035	S360SX		130	29.54	117.00	36	7	18	3	8	93,500.00	

✖✖ ราคารวมสารกรองทราย / Included Sand Media

หมายเหตุ : ราคายังไม่รวมภาษี 7% บริษัทฯ ขอสงวนสิทธิ์ในการเปลี่ยนแปลงราคาโดยไม่ต้องแจ้งให้ทราบล่วงหน้า  
 Remarks : Excluded VAT 7%. The Company reserves the right to change the prices without announcement.



# “HAYWARD” Multiport Valves & Accessories



Code	Model	In/Outlet (inches)	Type	Suitable	Retail Price	Code✘
20600800005	SP0710XR50	1.5	Side Mount	ProGrid Series D.E. Filter	7,200.00	B
20600800020	SP0715XR50	2			11,700.00	



Code	Model	In/Outlet (inches)	Type	Suitable	Retail Price	Code✘
20600800010	SP0714T	1.5	Top Mount	Pro Series Sand Filter	6,500.00	B
20600800025	SP071620T	2			9,500.00	



Code	Model	In/Outlet (inches)	Type	Suitable	Retail Price	Code✘
20600800015	SP0710X62	1.5	Side Mount	Pro Series Sand Filter	7,200.00	B
20600800030	SP0715X62	2			10,800.00	

หมายเหตุ : ราคายังไม่รวมภาษี 7% บริษัทฯ ขอสงวนสิทธิ์ในการเปลี่ยนแปลงราคาโดยไม่ต้องแจ้งให้ทราบล่วงหน้า  
 Remarks : Excluded VAT 7%. The Company reserves the right to change the prices without announcement.



# “ZELBRITE” Mineral Media For Sand Filters

**ZELBRITE IS AN ADVANCED FILTRATION MATERIAL THAT OUTPERFORMS THE TRADITIONAL POOL FILTRATION MEDIUMS OF SAND AND DIATOMACEOUS EARTH.**

It is manufactured from zeolitic material which is formed as a result of volcanic activity. There are a range of different zeolitic materials produced with varying properties. The key active ingredient in Zelbrite is the mineral clinoptilolite. Clinoptilolite has a proven scientific track record in water treatment and Zelbrite now brings these advanced filtration features which produce superior water quality and economic benefits, to the pool and spa industries.

### HOW LONG DOES ZELBRITE LAST?

The active component clinoptilolite is encased in a very solid and stable mineral complex which results in a very robust Zelbrite filtration particle. In fact most zeolitic material around the world is quite soft and would be totally unsuitable to withstand the rigours of filtration, backwashing and constant contact between particles. As a result Zelbrite has a prolonged life, better than sand, due to its exceptional hardness and resistance to attrition.

### BENEFITS OF THIS AMAZING SWIMMING POOL FILTRATION MATERIAL

The benefits this amazing swimming pool filtration material can be grouped into the following general areas:

- Water quality,
- Health benefits,
- Environmental and
- Economic benefits



### HIGH PERFORMANCE POOL FILTER MEDIA

Make your pool safer with ZELBRITE  
Reduce exposure to Giardia & Cryptosporidium

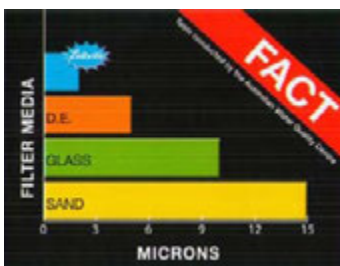
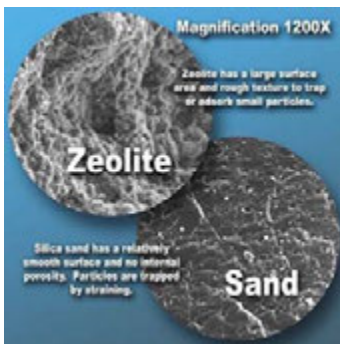

		Sand Filter	Diatomaceous Earth
<b>Media</b>	"Zelbrite" used continuously for many years	Sand used continuously for many years	Diatomaceous Earth replaced after every backwash
<b>Filtration Efficiency</b>	Excellent	Good	Excellent
<b>Filters To</b>	2-3 microns	15 microns	5 microns
<b>Multiple Mechanisms</b>	Yes	No	No
<b>Removes Ammonia</b>	Yes	No	No
<b>Reduces Chloramines</b>	Yes	No	No
<b>Convenience</b>	Excellent simple backwash	Excellent simple backwash	Not so convenient backwash to also remove unused DE
<b>Operating Cost</b>	Low as virtually permanent medium*	Low as virtually permanent medium	Medium, requires regular replacement of DE

\*Additional operating advantages of  
Less backwashing (water saving approx 30%)  
Less power  
Less pool chemicals

Supplied in 15 kg bags (equivalent to 20 kg filter sand), require 75% by weight of the amount of sand required



Code	Model	Description	Usage	Packing	Retail Price	Code✘
24002600005	Zelbrite	แร่ธาตุ Mineral	ปริมาณในการใช้ 75% ของปริมาณทราย Use 75% of the sand quantity	15 kgs	980.00	I★

หมายเหตุ : ราคายังไม่รวมภาษี 7% บริษัทฯ ขอสงวนสิทธิ์ในการเปลี่ยนแปลงราคาโดยไม่ต้องแจ้งให้ทราบล่วงหน้า  
Remarks : Excluded VAT 7%. The Company reserves the right to change the prices without announcement.



# “ECOCLEAR” Glass Media For Sand Filters

## WHAT IS ECOCLEAR ?

EcoClear is a new 100 recycled, environmentally friendly media that lasts up to 3 times longer than traditional Silica sand. This product will save you money and give you a cleaner healthier pool.

## FEATURES

- Saves up to 25% of water through quicker backwashing.
- Greater filtration capacity, longer time between backwashing.
- Filters down to 3 micron. Cleanest, clearest water available.
- Reduces bacteria growth in filter, saves on chemical usage.
- Electrostatic mechanical filtering
- Allows higher flow, this improved filtration
- Improves flow and reduces electrical costs
- Ultra low carbon footprint

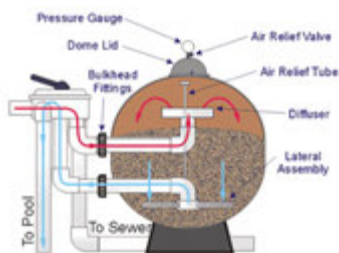

- Use Coarse media to cover laterals
- Then fill to same level as you would normally with sand
- 20kg Sand = 15kg glass EASY!!!



100% Recycled Bottled Glass media

Code	Model	Description	Size (mm)	Usage	Packing	Retail Price	Code✕
24003100020	EcoClear – Coarse	ทรายหยาบ Coarse	1.0 - 1.5	แบบหยาบ ปริมาณการใช้คือใส่ก่อนให้สารกรองทว้มแกนกรอง Coarse: Pour in coarse until normal position above laterals	25 kgs	1,390.00	
24003100025	EcoClear – Fine	ละเอียด Fine	0.2 - 0.5	แบบละเอียด ปริมาณการใช้คือใส่สารกรองละเอียดต่อจากสารกรองหยาบให้ได้ความสูงเท่ากับเวลาใส่ทราย Fine: Pour in fine until normal position (of sand)	25 kgs	1,390.00	I★

หมายเหตุ : ราคายังไม่รวมภาษี 7% บริษัทฯ ขอสงวนสิทธิ์ในการเปลี่ยนแปลงราคาโดยไม่ต้องแจ้งให้ทราบล่วงหน้า  
 Remarks : Excluded VAT 7%. The Company reserves the right to change the prices without announcement.



## Sand Media For Sand Filters



Code	Model	Description	Packing	Retail Price	Code✘
24003000005	Sand 0.4-0.6	สารกรองทราย ขนาด 0.4 - 0.6 มม. Sand media size 0.4 – 0.6 mm.	50 kgs	720.00	★
2004170005	Sand	Sand media	50 kgs	ทรายแถม	



## “EMAUX” Bio-Ring Media For LF Series Koi Fish Filters



Code	Model	Specific Surface Area (approx.)	Dimension	Packing	Retail Price	Code✘
24000510005-1	Bio-Ring ✘	1776 m <sup>2</sup> / m <sup>3</sup>	6.8 * 8 mm (length)	15 kgs	8,700.00	★

✘ สินค้าไม่มีสต็อก กรุณาสั่งซื้อล่วงหน้า / No Stock, Delivery Time : 60 - 90 Days

หมายเหตุ : ราคายังไม่รวมภาษี 7% บริษัทฯ ขอสงวนสิทธิ์ในการเปลี่ยนแปลงราคาโดยไม่ต้องแจ้งให้ทราบล่วงหน้า  
Remarks : Excluded VAT 7%. The Company reserves the right to change the prices without announcement.



# FILTRATION SYSTEMS





# “EMAUX” Ultra Series Filtration Combo with Pre-filter

## FOR ABOVE GROUND POOL

Designed for easy set-up above ground pool, “ULTRA” Series filtration combo offers an economical solution with user-friendly operation. The combo includes durable top mount plastic filter tank, 4-way multiport valve and swimming pool pump attached to the base. Silica sand is used for filter media instead of paper cartridge element, which offers excellent filtration performance with crystal clear pool water.

### INCLUDES

- Durable top mount plastic filter tank
- 4-way multiport valve
- Aqua-Mini Pump with Timer
- Timer (optional)

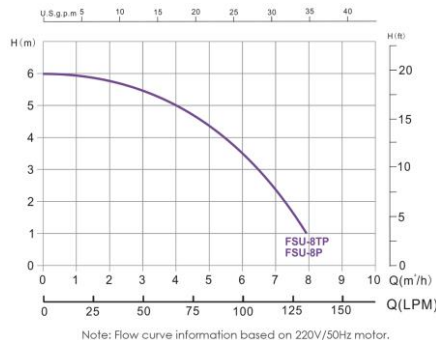

### Valve

4-Way Multiport Valve

### Max Working Pressure

28psi / 2bar

### Max Water Temperature

40°C (104°F)

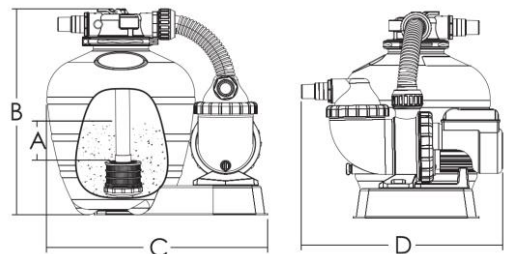

## Product Information and Dimension

Note: Suggested sand weight varies with differences in filter media size. For reference only.



Code	Model	Filter	Pump	Max. Flow Rate	Sand (kg)	A (mm)	B (mm)	C (mm)	D (mm)	Filter & Pump In/Out Connection	Adaptor
88033669	FSU-8TP	13" Filter	AMU020TP	133.3lpm 8.0m³/h	17	145	460	494	450	1.5" / 50 mm	1 1/4" & 1 1/2" 32 & 38mm

Code	Model	MV (inches)	Flowrate (m³/h)	Width (inches)	Sand (50kgs/bag)	Zelbrite (15kgs/bag)	EcoClear (25kgs/bag)		Pump	Retail Price	Code✳
							Coare	Fine			
20310510490	FSU-8TP	1.5	8.0	13	1 (20kgs)	1	1/2	1	AMU020TP	12,900.00	H★

✳✳ ราคารวมสารกรองทราย / Included Sand Media

หมายเหตุ : ราคายังไม่รวมภาษี 7% บริษัทฯ ขอสงวนสิทธิ์ในการเปลี่ยนแปลงราคาโดยไม่ต้องแจ้งให้ทราบล่วงหน้า

Remarks : Excluded VAT 7%. The Company reserves the right to change the prices without announcement.



# “EMAUX” FSM Series Sand Filtration Systems Complete Set With Pump & Based

### FSM FILTRATION COMBO INCLUDES

- Durable top mount plastic filter tank (Max Series Filter)
- 6-way Multiport Valve
- SPH Series Pump (SPH075 , SPH100 or SPH150)

### Max Temperature

50°C (122°F)

### Max Operating Pressure

40psi (2.8bar)

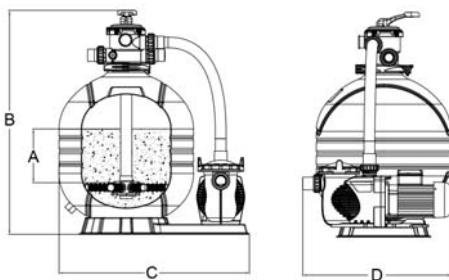
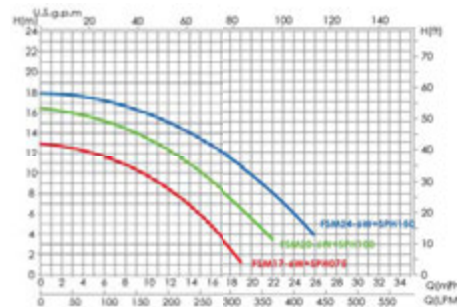

## Product Information and Dimension

Model	Filter	Pump	Sand (kg)	A (mm)	B (mm)	C (mm)	D (mm)	Filter & Pump In/Out Connection
FSM17-6W+SPH075	MFV17	SPH075	40	195	816	762.5	652	1.5" / 50 mm
FSM20-6W+SPH100	MFV20	SPH100	70	225	889	800	652	1.5" / 50 mm
FSM24-6W+SPH150	MFV24	SPH150	125	280	980	850	652	1.5" / 50 mm

Code	Model	MV (inches)	Head (10 m)	Width (inches)	Sand (50kgs/bag)	Zelbrite (15kgs/bag)	EcoClear (25kgs/bag)		Pump	Retail Price	Code ✖
							Coare	Fine			
20310510260	FSM17-6W+SPH075	1.5	9.5	17	1 (40kgs)	2	1/2	1	SPH075	33,200.00	
20310510265	FSM20-6W+SPH100	1.5	15.2	20	2 (70kgs)	4	1	2	SPH100	35,900.00	H ★
20310510271	FSM24-6W+SPH150	1.5	19.9	24	3 (125kgs)	7	1	3	SPH150	41,400.00	

✖✖ ราคารวมสารกรองทราย / Included Sand Media

หมายเหตุ : ราคายังไม่รวมภาษี 7% บริษัทฯ ขอสงวนสิทธิ์ในการเปลี่ยนแปลงราคาโดยไม่ต้องแจ้งให้ทราบล่วงหน้า  
 Remarks : Excluded VAT 7%. The Company reserves the right to change the prices without announcement.



# “EMAUX” FSF Series Sand Filtration Systems Complete Set With Pump & Based

### STANDARD FEATURES

- Suggested Installation : Domestic swimming pool
- Easy Installation with pre-installed plumbing system & base
- Simple operation with 6-way multiport valve
- Filter structure with UV resistance material

### Valve

6-Way Multiport Valve

### Max Water Temperature

43°C (109°F)

### Max Working Pressure

36psi/2.5bar

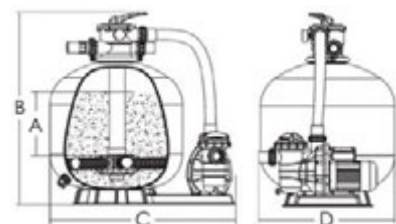
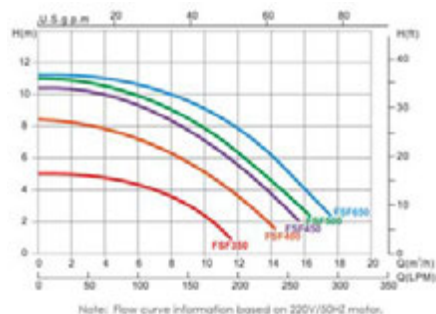

## Product Information and Dimensions

Note: Suggested sand weight varies with the differences in filter media size. For reference only.

Model	Filter	Pump	Valve Connections	Sand (kg)	A (mm)	B (mm)	C (mm)	D (mm)	Max. Flow Rate
FSF350-6W	V350	SS033	1.5" / 50mm	20	160	680	555	355	72lpm 4.32m³/h
FSF400-6W	V400	SS050	1.5" / 50mm	35	175	759	760	410	108lpm 6.48m³/h
FSF450-6W	V450	SS075	1.5" / 50mm	45	210	813	760	455	135lpm 8.10m³/h
FSF500-6W	V500	SC100	1.5" / 50mm	85	235	856	760	535	185lpm 11.10m³/h
FSF650-6W	V650	SC150	1.5" / 50mm	145	300	961	760	635	260lpm 15.60m³/h

Code	Model	MV (inches)	Flowrate (m³/h)	Height (cm)	Width (inches)	Sand (50kgs/bag)	Zelbrite (15kgs/bag)	EcoClear (25kgs/bag)		Pump	Retail Price	Code ✖
								Coare	Fine			
20310510255	FSF350-6W	1.5	4.31	72.60	14	1 (20kgs)	1	1/2	1	SS033	24,000.00	H★
20310510260	FSF400-6W	1.5	6.48	75.70	16	1 (35kgs)	2	1/2	1	SS050	26,500.00	
20310510265	FSF450-6W	1.5	8.10	81.40	18	1 (45kgs)	3	1/2	1	SS075	29,000.00	
20310510270	FSF500-6W	1.5	11.10	84.50	21	2 (85kgs)	5	1	2	SC100	33,000.00	
20310510275	FSF650-6W	1.5	15.60	95.00	25	3 (145kgs)	8	1	3	SC150	38,500.00	

✖✖ ราคารวมสารกรองทราย / Included Sand Media

หมายเหตุ : ราคายังไม่รวมภาษี 7% บริษัทฯ ขอสงวนสิทธิ์ในการเปลี่ยนแปลงราคาโดยไม่ต้องแจ้งให้ทราบล่วงหน้า

Remarks : Excluded VAT 7%. The Company reserves the right to change the prices without announcement.



# “EMAUX” FSCO Series Cartridge Filtration Systems Complete Set With Pump & Base Include UV Resistant Cartridge Filter Tank

**FEATURES**

- Easy setup and operate
- UV resistance cartridge filter tank
- Heavy Duty ring-lock lid allows easy-open for cleaning and replacing cartridge element
- Oil filled pressure gauge for easy inspection of the operation pressure
- Attached with circulation pump with IPX5 Waterproof standard certified and built-in thermal protection
- Application to domestic swimming pool & spa

**Max Temperature** 40°C (109°F)      **Max Operating Pressure** 36psi (2.5bar)      **Cartridge Size** 25ft<sup>2</sup> - 200ft<sup>2</sup>

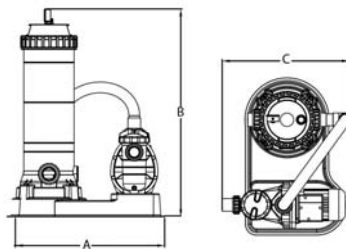
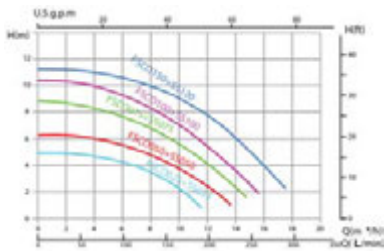

Model	Cartridge Filter	Pump	Valve Connections	A (mm)	B (mm)	C (mm)
FSCO025+SS033	CF25	SS033	1.5" / 50mm	705	580	507
FSCO050+SS050	CF50	SS050	1.5" / 50mm	705	760	552
FSCO075+SS075	CF75	SS075	1.5" / 50mm	705	940	552
FSCO100+SS100	CF100	SS100	1.5" / 50mm	705	1120	552
FSCO150+SS120	CF150	SS120	1.5" / 50mm	705	1300	552

Code	Model	In/Outlet (inch)	Flowrate (m <sup>3</sup> /h)	Head (m)	Cartridge Filters	Pump	Retail Price	Code✖
20510510035	FSC025+SS033	1.5	--	--	CF25	SS033	22,500.00	H★
20510510040	FSC050+SS050	1.5	8.0	5	CF50	SS050	26,300.00	
20510510045	FSC075+SS075	1.5	10.0	5.8	CF75	SS075	29,000.00	
20510510050	FSC100+SS100	1.5	11.8	6	CF100	SS100	33,300.00	
20510510055	FSC150+SS120	1.5	13.0	7	CF150	SS120	37,200.00	

หมายเหตุ : ราคายังไม่รวมภาษี 7% บริษัทฯ ขอสงวนสิทธิ์ในการเปลี่ยนแปลงราคาโดยไม่ต้องแจ้งให้ทราบล่วงหน้า  
Remarks : Excluded VAT 7%. The Company reserves the right to change the prices without announcement.



# “EMAUX” EMD Series In-Ground Filtration System Combo Set

Easy installation with pre-installed plumbing and durable, weatherproof enclosure

**Max Working Pressure**  
36psi/2.5bar

**FEATURES**

- Suggested Installation :  
Domestic swimming pool
- Easy Installation with pre-installed plumbing system with durable enclosure
- Simple operation with control box
- UV resistance material for the top cover

**Suggested Size Of Media**  
0.5-0.8mm

**Max Water Temperature**  
40°C (109°F)



Series	Pool Volume (Turnover 5 hrs/day)	Flow Rate	Filter	Pump	Message Pump (if any)
EMD-7	< 35m <sup>3</sup>	7 m <sup>3</sup> /h	S450	SS033	SR30
EMD-11	< 50m <sup>3</sup>	10 m <sup>3</sup> /h	S500	SS050	SR30
EMD-14	< 65m <sup>3</sup>	13 m <sup>3</sup> /h	S650	SS100	SR30
EMD-18	< 90m <sup>3</sup>	18 m <sup>3</sup> /h	S700	SC150	SR30
EMD-22	< 105m <sup>3</sup>	21 m <sup>3</sup> /h	S700(B)	SC150	SR30
EMD-25	< 130m <sup>3</sup>	26 m <sup>3</sup> /h	S800	SB200	SR30
EMD-32	< 155m <sup>3</sup>	31 m <sup>3</sup> /h	S900	SB300	SR30

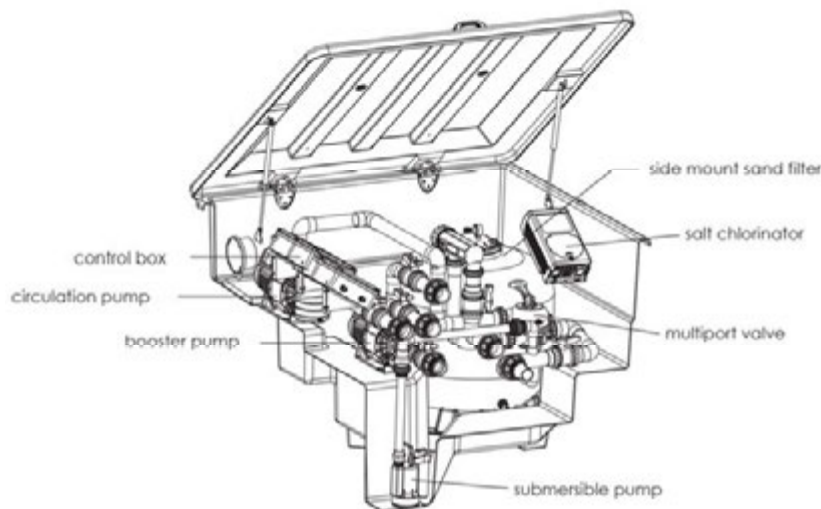
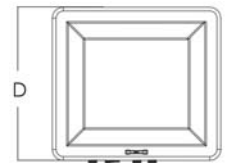
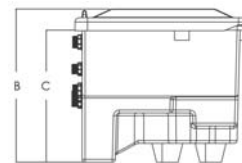
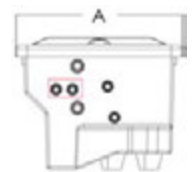

Model	A mm	B mm	C mm	D mm
EMD-7	1330	1055	905	1210
EMD-11	1330	1055	905	1210
EMD-14	1330	1055	905	1210
EMD-18	1400	1220	1080	1340
EMD-22	1400	1220	1080	1340
EMD-25	1730	1315	1170	1630
EMD-32	1730	1315	1170	1630





Code	Model	Description	Retail Price	Code✕
20100510005	PSB016 ✕	220V-240V/50HZ Portable Submersible Pump	14,900.00	I



**EMD Series In-Ground Filtration System Combo Set**

Filters & Pump	Code	Model	Chlorine feeder	Message Pump	Submersible Pump	Retail Price	Code✕
Sand Filter S450 & Pump SS033	20310510280	EMD-7C ✕	✓		✓	141,000.00	I
	20310510285	EMD-7CP ✕	✓	✓	✓	186,000.00	
Sand Filter S500 & Pump SS050	20310510310	EMD-11C ✕	✓		✓	145,000.00	
	20310510315	EMD-11CP ✕	✓	✓	✓	188,000.00	
Sand Filter S650 & Pump SS100	20310510340	EMD-14C ✕	✓		✓	152,000.00	
	20310510345	EMD-14CP ✕	✓	✓	✓	196,000.00	
Sand Filter S700 & Pump SC150	20310510370	EMD-18C ✕	✓		✓	169,000.00	
	20310510375	EMD-18CP ✕	✓	✓	✓	214,000.00	
Sand Filter S700B & Pump SC150	20310510400	EMD-22C ✕	✓		✓	176,000.00	
	20310510405	EMD-22CP ✕	✓	✓	✓	224,000.00	
Sand Filter S800 & Pump SB020	20310510430	EMD-25C ✕	✓		✓	218,000.00	
	20310510435	EMD-25CP ✕	✓	✓	✓	268,000.00	
Sand Filter S900 & Pump SB030	20310510460	EMD-32C ✕	✓		✓	223,000.00	
	20310510465	EMD-32CP ✕	✓	✓	✓	278,000.00	

✕ สินค้าไม่มีสต็อก กรุณาสั่งซื้อล่วงหน้า / No Stock, Delivery Time : 60 - 90 Days

หมายเหตุ : ราคายังไม่รวมภาษี 7% บริษัทฯ ขอสงวนสิทธิ์ในการเปลี่ยนแปลงราคาโดยไม่ต้องแจ้งให้ทราบล่วงหน้า  
 Remarks : Excluded VAT 7%. The Company reserves the right to change the prices without announcement.



# Filtration System Complete Set On Fiberglass Structure

**Standard Features**

- Easy Installation
- Suggested Installation : Domestic swimming pool

**Pump SPH075 Flowrate 9.60 m<sup>3</sup>/hr**

- Pool Volume 40 m<sup>3</sup> – Turn Over at 4 hours/day
- Pool Volume 60 m<sup>3</sup> – Turn Over at 6 hours/day
- Pool Volume 80 m<sup>3</sup> – Turn Over at 8 hours/day



**Filtration System Complete Set  
With Salt Chlorinator**

Size : W 1.10 x L 1.00 x H 1.00 M.

**Filtration System Complete Set  
With Salt Chlorinator & Spa Pump**

Size : W 1.10 x L 1.50 x H 1.00 M.





Filtration System Complete Set With Salt Chlorinator

<b>MFV20</b>	"EMAUX" Top Mount Sand Filter 20", Inc. Multiport Valve 1.5", Flowrate 10 m <sup>3</sup> /h,	1	set
<b>Zelbrite</b>	"ZELBRITE" Mineral Media for Sand Filter, Packing 15 kgs/bag	4	bags
<b>SSC-mini</b>	"EMAUX" Salt Chlorinator 20 g/hr, For Pool 45 - 70 m <sup>3</sup>	1	set
<b>SPH075</b>	"EMAUX" Pool Pump Complete Set with Union 1.5" / 2", 0.75HP/220V/1PH, Flowrate 9.6 m <sup>3</sup> /hr (Head @ 10 m.)	1	set
<b>FM10-1.0</b>	True Union Ball Valve, Size 1"	1	set
<b>126404</b>	"PREAQUA" Corn Check Valve - S6 DN40 PVC Gray PVC-U Solvent Socket Ends, Size 1.5"	1	set
<b>125473</b>	"PREAQUA" True Union Ball Valve - S6 2W PVC Gray PVC-U Solvent Socket Ends, Size 2"	6	sets
	Electrical Control Box with Timer & Transformer for Underwater Light (50W)	1	set
	Fiberglass Structure with Piping & Accessories	1	set

Code	Model	Descriptions	Retail Price	Code✖
20900510120	CPS-01 ✖	Suitable With Pool Volume 60m <sup>3</sup> : Turnover 6 Hours/day Size : Width 1.10 x Length 1.00 x Height 1.00 meters	กรุณาติดต่อเจ้าหน้าที่ / Please Check with Sales Assistance	

Filtration System Complete Set With Salt Chlorinator & Spa Pump

<b>MFV20</b>	"EMAUX" Top Mount Sand Filter 20", Inc. Multiport Valve 1.5", Flowrate 10 m <sup>3</sup> /h,	1	set
<b>Zelbrite</b>	"ZELBRITE" Mineral Media for Sand Filter, Packing 15 kgs/bag	4	bags
<b>SSC-mini</b>	"EMAUX" Salt Chlorinator 20 g/hr, For Pool 45 - 70 m <sup>3</sup>	1	set
<b>SPH075</b>	"EMAUX" Pool Pump Complete Set with Union 1.5" / 2", 0.75HP/220V/1PH, Flowrate 9.6 m <sup>3</sup> /hr (Head @ 10 m.)	1	set
<b>SPH200</b>	"EMAUX" Pool Pump Complete Set with Union 1.5" / 2", 2.0HP/220V/1PH, Flowrate 23.20 m <sup>3</sup> /hr (Head @ 10 m.)	1	set
<b>FM10-1.0</b>	True Union Ball Valve, Size 1"	1	set
<b>126404</b>	"PREAQUA" Corn Check Valve - S6 DN40 PVC Gray PVC-U Solvent Socket Ends, Size 1.5"	1	set
<b>126405</b>	"PREAQUA" Corn Check Valve - S6 DN40 PVC Gray PVC-U Solvent Socket Ends, Size 2"	1	set
<b>125473</b>	"PREAQUA" True Union Ball Valve - S6 2W PVC Gray PVC-U Solvent Socket Ends, Size 2"	8	sets
	Electrical Control Box with Timer & Transformer for Underwater Light (50W)	4	set
	Fiberglass Structure with Piping & Accessories	4	set

Code	Model	Descriptions	Retail Price	Code✖
2090050125	CPS-02 ✖	Suitable With Pool Volume 60m <sup>3</sup> : Turnover 6 Hours/day Size : Width 1.50 x Length 1.00 x Height 1.00 meter	กรุณาติดต่อเจ้าหน้าที่ / Please Check with Sales Assistance	

✖ สินค้าไม่มีสต็อก กรุณาสั่งล่วงหน้า 15-30 วัน / No Stock, Delivery Time 15-30 Days

หมายเหตุ : ราคายังไม่รวมภาษี 7% บริษัทฯ ขอสงวนสิทธิ์ในการเปลี่ยนแปลงราคาโดยไม่ต้องแจ้งให้ทราบล่วงหน้า  
Remarks : Excluded VAT 7%. The Company reserves the right to change the prices without announcement.



# Fiberglass Machine Rooms

## FEATURES

- Suggested Installation : Domestic swimming pool
- Easy Installation & Access
- Waterproof & UV resistance material



ROOM - 01

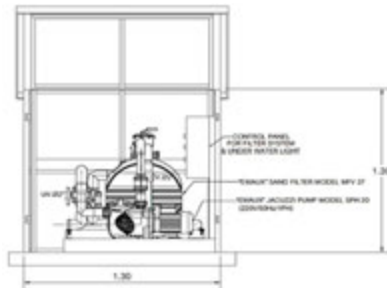

ROOM - 02

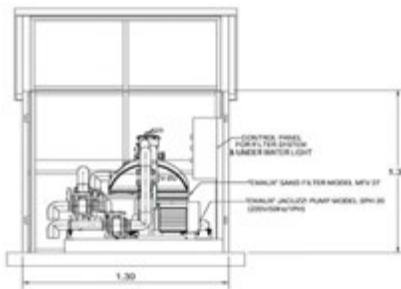

Code	Model	Descriptions	Retail Price	Code✘
22201610005	ROOM-01 ✘	Fiber Glass Room Size W 1.30 x L 1.30 x H 1.30 meters	55,000.00	A
22201610010	ROOM-02 ✘	Fiber Glass Room Size W 1.30 x L 1.70 x H 1.30 meters	72,000.00	

✘ สินค้าไม่มีสต็อก กรุณาสั่งซื้อล่วงหน้า / No Stock, Delivery Time : 15 - 30 Days



# Premium Heavy Duty Trolleys

Code	Model	Description	Size	Retail Price	Code✘
20551610005	Trolley – A	Fiberglass & Stainless Steel Tory Inc. Piping + Control Box + Accessories (Exc. Filter & Pump)	0.60 x 0.75 cm	32,000.00	A
20551610010	Trolley – B		0.60 x 1.00 cm	35,000.00	

หมายเหตุ : ราคายังไม่รวมภาษี 7% บริษัทฯ ขอสงวนสิทธิ์ในการเปลี่ยนแปลงราคาโดยไม่ต้องแจ้งให้ทราบล่วงหน้า  
Remarks : Excluded VAT 7%. The Company reserves the right to change the prices without announcement.



# PUMPS





# “SPECK” BADU Resort Series Commercial Pool Pumps Complete Set With Unions Made In Germany

## DESIGN

Monoblock-type pump with integrated strainer tank. The bellows-type mechanical seal is mounted on a plastic shaft protector sleeve. Motor/pump shaft has no contact with the pool water providing complete electrical separation.

Strainer capacity : approx. . 10 l

Strainer basket mesh size : approx. 3.4 x 3.2 mm

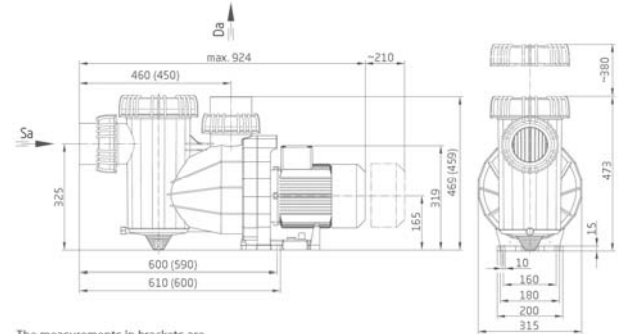

The measurements in brackets are for BADU Resort 30 to BADU Resort 45.



Model	BADU Resort 70	BADU Resort 80	BADU Resort 110
In/Outlet (inches)	4" / 4"	4" / 4"	4" / 4"
Flowrate (gpm)	286	361	462
Flowrate (m³/h)	65	82	106
Head (m)	10	10	10
Pool Volume (m3)			
Turnover 6 hr/day	390	492	636
Turnover 8 hr/day	520	656	848
KW	3.0	4.0	5.5
Amp	7.5	10.0	13.7

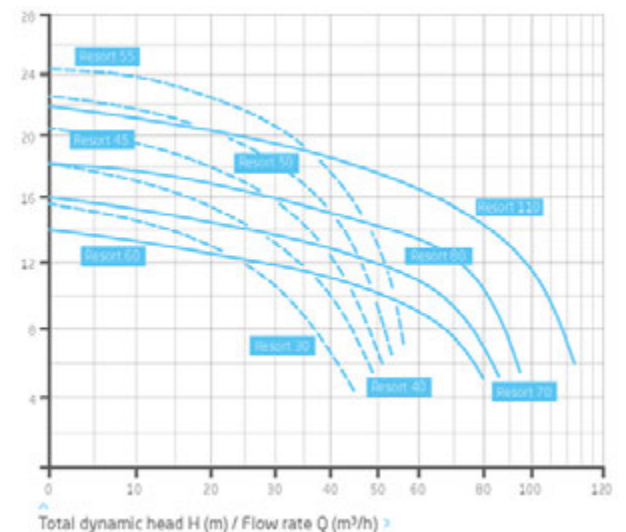

Code	Model	H.P.	Voltage	Phase	Retail Price	Code✖
20701930015	BADU Resort 70 ✖	4.0	380	3	109,000.00	B
20701930005	BADU Resort 80 ✖	5.5	380	3	119,000.00	
20701930010	BADU Resort 110 ✖	7.5	380	3	139,000.00	

✖ สินค้าไม่มีสต็อก กรุณาสั่งซื้อล่วงหน้า / No Stock, Delivery Time : 60 – 90 Days

หมายเหตุ : ราคายังไม่รวมภาษี 7% บริษัทฯ ขอสงวนสิทธิ์ในการเปลี่ยนแปลงราคาโดยไม่ต้องแจ้งให้ทราบล่วงหน้า  
Remarks : Excluded VAT 7%. The Company reserves the right to change the prices without announcement.



# “EMAUX” SWP Series Corrosion Resistant FRP Pump



**FEATURES**

1. Complies with European DIN Standard
2. Smooth hydraulic passages to increase pump efficiency
3. Tapered polygon impeller provides good capacity and greater efficiency
4. Externally adjustable impeller clearance provides ease of maintenance and maximum efficiency
5. All wetted parts in either Vinyl Ester Epoxy Resin provide better chemical resistance
6. Casting through bolts maintain casing o-ring seal integrity under all hydraulic operating conditions
7. Integral Shaft Sleeve Design protects the pump Shaft from exposure to the process fluid
8. Large capacity Swedish made SKF bearing ensure long operation life
9. Heavy-duty shaft minimizes deflection to maximize mechanical seal life
10. External type AISI-316L mechanical seal for highly corrosive fluids, static and rotating ring in SiC and Spring
11. Polyester thermosetting powder coated power frame construction to prevent external corrosion
12. Coupled to ABB Motor. Optional earthing rings or insulated bearings to prevent bearing erosion when installing with VFD.

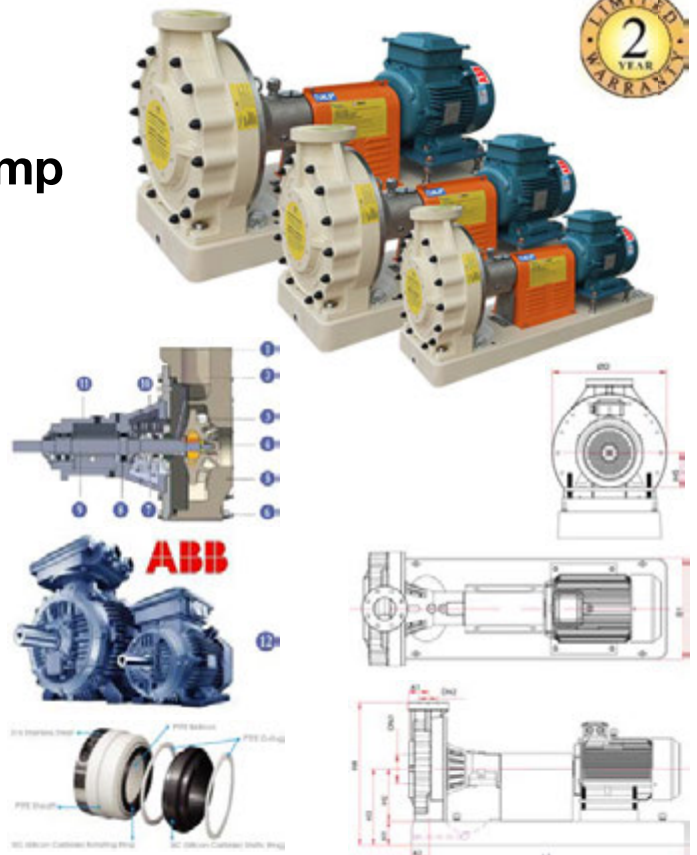

**Product Dimensions**

Model (Inlet x Outlet)	L1	L2	H1	H2	H3	H4	H5	DB1	DB2	DB3	DB4	
	[mm]							[inch / mm]				
100 x 80	1200	420	100	210	310	590	112	4'11/8"	3'8"	458	182	78
150 x 80	1200	420	100	210	310	590	132	4'11/8"	3'8"	458	182	78
150 x 100	1450	480	100	254	354	697	132	6'1/50"	4'11/100"	540	102	78
150 x 100	1450	480	100	254	354	697	160	6'1/50"	4'11/100"	540	102	78
200 x 150	1530	570	100	368	468	874	160	8'2/200"	6'1/150"	700	152	93
200 x 150	1530	570	100	368	468	874	180	8'2/200"	6'1/150"	700	152	93
300 x 250	2032	600	100	457	557	1217	280	12'3/100"	10'2/250"	1003	197	203

Code	Model	Inlet x Outlet x Impeller Dia (mm)	RMP	H.P.	Voltage	Phase	Retail Price	Code✕
20700510350	SWP550-6P✕	150 x 100 x 250	950	5.5	380	3	กรุณาติดต่อเจ้าหน้าที่ / Please Check with Sales Assistance	
20700510355	SWP750-6P✕	150 x 100 x 270mm	950	7.5	380	3		
20700510360	SWP1000-6P✕	200 x 150 x 270mm	950	10.0	380	3		
20700510365	SWP1500-6P✕	200 x 150 x 300mm	950	15.0	380	3		
20700510370	SWP6000-6P✕	300 x 250 x 405mm	950	60.0	380	3		
20700510375	SWP550-4P✕	100 x 80 x 205mm	1450	5.5	380	3		
20700510380	SWP750-4P✕	100 x 80 x 220mm	1450	7.5	380	3		
20700510385	SWP1000-4P✕	150 x 100 x 225mm	1450	10.0	380	3		
20700510390	SWP1500-4P✕	150 x 100 x 250mm	1450	15.0	380	3		
20700510395	SWP2000-4P✕	200 x 150 x 250mm	1450	20.0	380	3		
20700510400	SWP2500-4P✕	200 x 150 x 265mm	1450	25.0	380	3		
20700510405	SWP3000-4P✕	200 x 150 x 280mm	1450	30.0	380	3		
20700510410	SWP4000-4P✕	200 x 150 x 295mm	1450	40.0	380	3		
20700510415	SWP5000-4P✕	200 x 150 x 310mm	1450	50.0	380	3		
20700510420	SWP6000-4P✕	200 x 150 x 325mm	1450	60.0	380	3		
20700510425	SWP1000-2P✕	100 x 80 x 155mm	2900	10.0	380	3		
20700510430	SWP1500-2P✕	100 x 80 x 170mm	2900	15.0	380	3		
20700510435	SWP2000-2P✕	100 x 80 x 190mm	2900	20.0	380	3		
20700510440	SWP2500-2P✕	100 x 80 x 200mm	2900	25.0	380	3		
20700510445	SWP3000-2P✕	100 x 80 x 215mm	2900	30.0	380	3		

✕ สินค้าไม่มีสต็อก กรุณาสั่งล่วงหน้า 90 วัน / No Stock, Delivery Time 90 Days

หมายเหตุ : ราคายังไม่รวมภาษี 7% บริษัทฯ ขอสงวนสิทธิ์ในการเปลี่ยนแปลงราคาโดยไม่ต้องแจ้งให้ทราบล่วงหน้า

Remarks : Excluded VAT 7%. The Company reserves the right to change the prices without announcement.



# “EMAUX” MER Series Basket Strainer

## A ROBUST AND DURABLE PREFILTER

For swimming pool, aquatic park, aquarium & zoo, and water treatment. Commercial basket strainer is designed to install with Emaux SWP series FRP pump to give the best performance of the water circulation system. The basket strainers are applicable in both saltwater and freshwater system.

## STOPS LARGE SOLIDS

The basket strainer comes with a heavy-duty PVC basket that perform as a pre-filter for the pump. It is typically installed prior to the pump to filter the relatively big solid impurities to protect the pumps, meters, and valves.

## FEATURES

- Molded FRP body for structural strength and corrosion resistance.
- Engineered for low-pressure drops making it an excellent choice for pump suction applications.
- Heavy-duty hardware and components.
- Transparent sight-glass window installed on lid
- Max operating pressure 36 psi (2.5 bar)

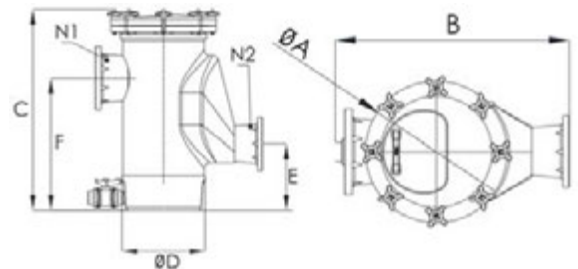

## Product Information and Dimension:

Code	Model	Diameter A (mm)	Length B (mm)	Height C (mm)	Diameter D (mm)	Length E (mm)	Length F (mm)	Inlet Flange N1 GB (mm)	Outlet Flange N2 GB (mm)	Capacity (m <sup>3</sup> /h)
9210414	MER100-100S	445	830	851	360	310	523	100	100	58
9210413	MER150-100S	565	965	981	440	310	593	150	100	123
9210412	MER200-150S	565	985	1113	440	354	705	200	150	192
9210411	MER250-200S	615	990	1260	490	468	837	250	200	301
9210410	MER300-200S	615	990	1260	490	468	837	300	200	447

Code	Model	Inlet (mm)	Outlet (mm)	Retail Price	Code✘
20700510450	MER100-100P✘	100	100	กรุณาติดต่อเจ้าหน้าที่ / Please Check with Sales Assistance	
20700510455	MER150-100S✘	150	100		
20700510460	MER200-150S✘	200	150		
20700510465	MER250-200S✘	250	200		
20700510485	MER300-200S✘	300	200		

✘ สินค้าไม่มีสต็อก กรุณาสั่งซื้อล่วงหน้า / No Stock, Delivery Time : 60 - 90 Days

หมายเหตุ : ราคายังไม่รวมภาษี 7% บริษัทฯ ขอสงวนสิทธิ์ในการเปลี่ยนแปลงราคาโดยไม่ต้องแจ้งให้ทราบล่วงหน้า  
Remarks : Excluded VAT 7%. The Company reserves the right to change the prices without announcement.



# “EMAUX” C-SE Series Commercial Pool Pumps With Stainless Steel Impeller

### HEAVY DUTY APPLICATIONS

SE Series Commercial Iron Pump build to cater commercial usage (e.g. Large size swimming pool, spa pool, water feature, etc). Cast iron body with easy to clean large strainer basket. Stainless steel or Metal impellers options are available to match your need, range from 5.5 HP to 15 HP.

### FEATURES

- Cast iron body with AISI-304 S.S. basket
- AISI 304 Stainless steel Impeller
- Available with ABB motor
- Asynchronous, Two Poles
- Class insulation: 130 (B)
- IP55 Waterproof Standard
- Built-in thermal protection
- Overload protection
- Testing Pressure 50 PSI (3.5 Bar)
- Basket Volume 5 litres

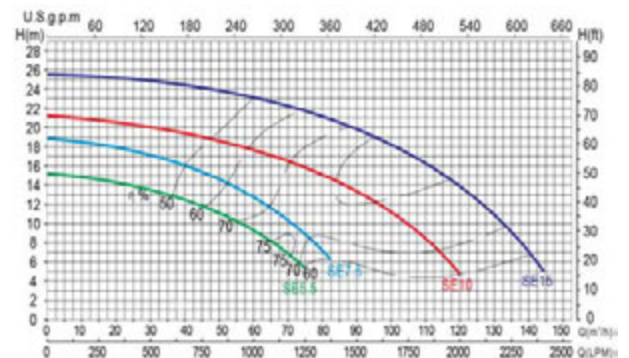

Remark: The performance curve above is for 50Hz models.

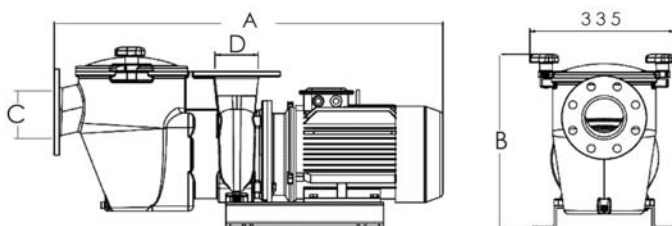

Model 50Hz	Input (kW)	Current (AMP)	Noise (dB)	Head (m)					
				8	10	12	14	16	18
SE5.5	4.70	7	72	65	55	42.5	25	--	--
SE7.5	6.40	9	76	77.5	71	62.5	52.5	40	20
SE10	8.60	14	75	111.5	104	97	85	75	55
SE15	12.40	18	78	137.5	132.5	126.5	120	110	101

Model	Connection Size	Horsepower	Output power (kW)	Voltage	Weight (kg)	A mm	B mm	C mm	D mm
SE5.5	3" / 90mm	5.5hp	4.0	380-420	95	860	415	DN80	DN80
SE7.5	3" / 90mm	7.5hp	5.5	380-420	100	860	415	DN80	DN80
SE10	4" / 110mm	10hp	7.5	380-420	118	915	445	DN100	DN100
SE15	4" / 110mm	15hp	11.0	380-420	130	945	445	DN100	DN100





AISI-304 Stainless Steel Impeller

SE Commercial Pump is designed for large swimming pools, spa pools and water features

Code	Model	H.P.	Voltage	Phase	In/Outlet (inches)	Flowrate (gpm)	Flowrate (m <sup>3</sup> /h)	Head (m)	Noise (dB)	Amp	Retail Price	Code✖
20700510075	C-SE5.5-SS✖	5.5	380	3	3	242.00	55.00	10	72	10.5	70,900.00	B
20700510085	C-SE7.5-SS✖	7.5	380	3	3	308.00	70.00	10	76	14.4	79,900.00	
20700510095	C-SE10-SS✖	10.0	380	3	4	458.00	104.00	10	76	19.7	91,900.00	
20700510105	C-SE15-SS✖	15.0	380	3	4	585.00	133.00	10	78	18.3	109,900.00	

✖ สินค้าไม่มีสต็อก กรุณาสั่งซื้อล่วงหน้า / No Stock, Delivery Time : 60 - 90 Days

หมายเหตุ : ราคายังไม่รวมภาษี 7% บริษัทฯ ขอสงวนสิทธิ์ในการเปลี่ยนแปลงราคาโดยไม่ต้องแจ้งให้ทราบล่วงหน้า  
 Remarks : Excluded VAT 7%. The Company reserves the right to change the prices without announcement.



# “EMAUX” APS Series Hydrau-Power Commercial Pump

## EXCELLENT RESISTANCE TO SEAWATER CORROSION

The Emaux Hydrau-Power pump is a series of powerful and robust pumps engineered for applications requiring high flow capability and efficiency. The pump is constructed with high strength and corrosion resistant thermoplastic materials and equipped with a large capacity strainer. The Hydrau- Power pump is suitable for a variety of different applications includes all types of commercial pools, aquatic parks and seawater facilities

## FEATURES

- High volume self-priming plastic pump ideal for large filtration system
- Smooth throat volute design provides high hydraulic efficiency of 85%
- Fiber reinforced plastic casing provides substantial temperature, pressure, vibration and impact performance
- Secondary seal chamber as water leakage and vaporize blocker to the motor
- Large suction-side detachable strainer capacity in 13 and 30 Liter
- Premium Efficiency IE3 Class Motor (compliance IEC 60034-30)
- Francis-vane impeller allows for broad-band efficiency and large flow region
- Low noise level up to 68 dB

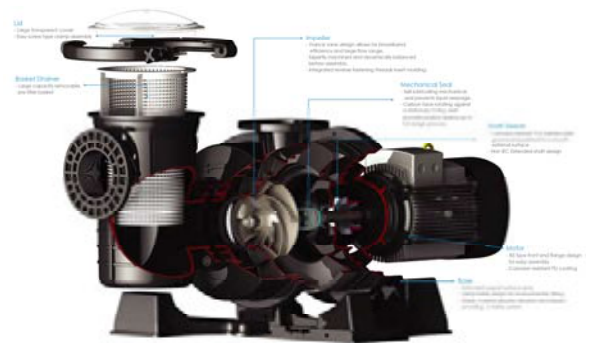

13L/30L  
Strainer Basket



Francis-Vane  
Impeller



IE 3 Class  
Motor

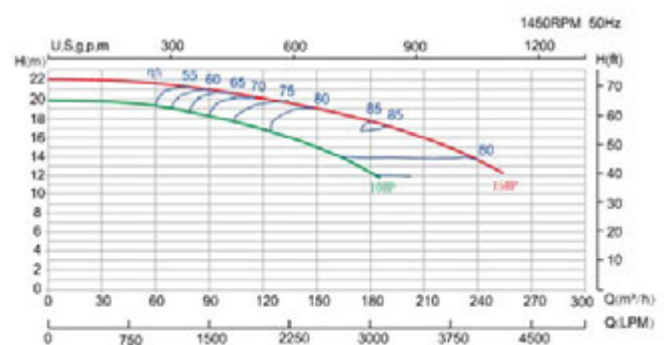
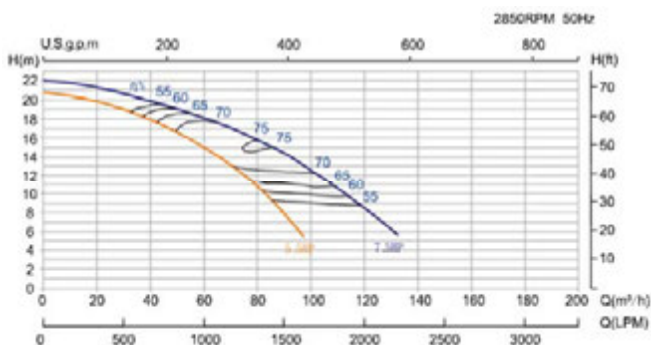

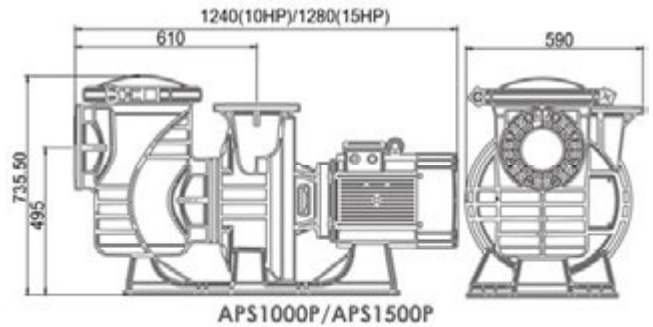
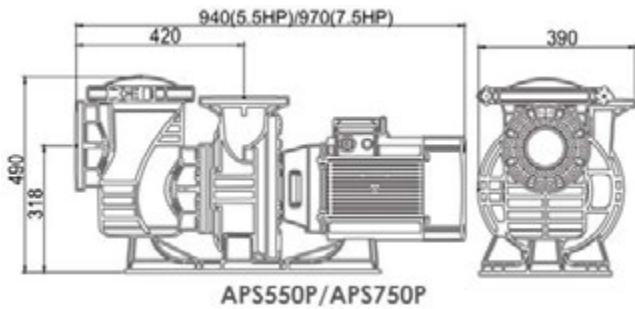

Model	Connection Size ANSI / DIN	Horsepower (hp)	Strainer Vol (L)	RPM	Power (kW)	Noise (dB)	Head (m)					
							6	8	10	12	14	16
APS550P	4"/DN100	5.5	13	2850	4	72	95	90	82	75	65	50
APS750P	4"/DN100	7.5	13	2850	5.5	72	130	120	110	105	90	80
APS1000P	6"/DN150	10	30	1450	7.5	68	--	210	185	180	160	135
APS1500P	6"/DN150	15	30	1450	11	68	--	270	260	250	240	210

Motor	Premium Efficiency IE3 Class Motor	Water Proof	IP55
Working Voltage	380Vac 50Hz, 3 Phase 400/690Vac 50Hz, 3 phase* 400/690Vac 60Hz, 3 phase*	Flow Rate	Up to 280m <sup>3</sup> /h
Design Methodology	Advanced computer 3D design modeling for CFD analysis	Differential Head	Up to 22m
Design Reference (Applicable only)	ISO 5199 : 2002	Speed	2 pole up to 2850 rpm 4 pole up to 1450 rpm
Operating Pressure	0-2 bar 25°C to 35°C	Insulation System	Class F
Temperature Range	0°C to 45°C (Water) 0°C to 45°C (Ambient)	Flange Standard	DIN (PN10) ANSI (Class150)

\* Under development

Code	Model	In/Outlet (inches)	Flowrate (m <sup>3</sup> /h)	Head (m)	Noise (dB)	H.P.	V	Phase	Amp	Retail Price	Code✕
20700510320	APS550P✕	4	82	10	72	5.5	380	3	10.5	72,000.00	B
20700510325	APS750P✕	4	110	10	72	7.5	380	3	14.4	83,000.00	
20700510330	APS1000P✕	6	185	10	68	10.0	380	3	19.7	131,000.00	
20700510335	APS1500P✕	6	260	10	68	15.0	380	3	18.3	149,000.00	

✕ สินค้าไม่มีสต็อก กรุณาสั่งซื้อล่วงหน้า / No Stock. Delivery Time : 60 - 90 Days

หมายเหตุ : ราคายังไม่รวมภาษี 7% บริษัทฯ ขอสงวนสิทธิ์ในการเปลี่ยนแปลงราคาโดยไม่ต้องแจ้งให้ทราบล่วงหน้า  
Remarks : Excluded VAT 7%. The Company reserves the right to change the prices without announcement.



# “EMAUX” UPH Series Ultra-Power Commercial Pump

## Supreme Performance Self-priming pump

Ultra-Power is a series of high-performance pumps designed to achieve the highest flows among similar pumps on the market. By utilizing state-of-the-art engineering, the one-piece molded pump body with a large capacity 8-liter strainer basket makes it unique among all comparable pumps. Built with corrosion and chemical resistant glass-reinforced thermoplastic and superior seawater graded mechanical seal guarantee a long working life.



## Outstanding Hydraulic Performance

- The Ultra-Power pump is Emaux's first commercial pump
- with a 3" union to achieve the hydraulic performance of
- more than 45m<sup>3</sup>/h at 18m of head (7hp model). With a
- wide selection of power options (from 4, 5.5, 7hp)
- available in 3-phase motors, it becomes one of the most
- efficient and energy-saving solutions for various ranges
- of the commercial pool and seawater facilities.

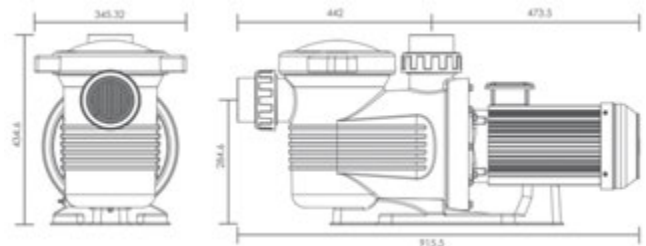

## Specification

1. Water Proof: IPX5
2. Self Priming: 3 m
3. Flow rate: Up to 110 m<sup>3</sup>/h
4. Working Voltage: 380-400Vac
5. Premium Efficiency IE3 Class Motor
6. Bearing: High temperature resistant up to 160°C

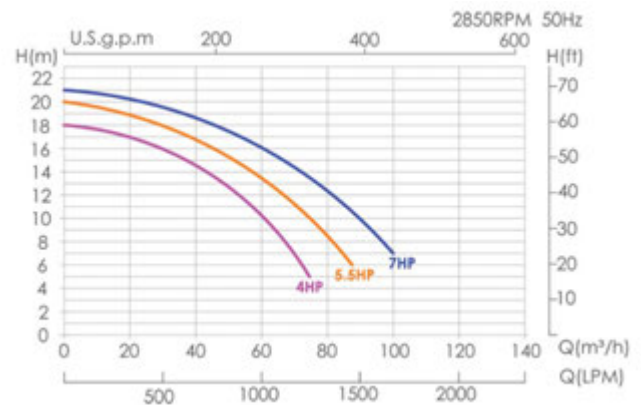

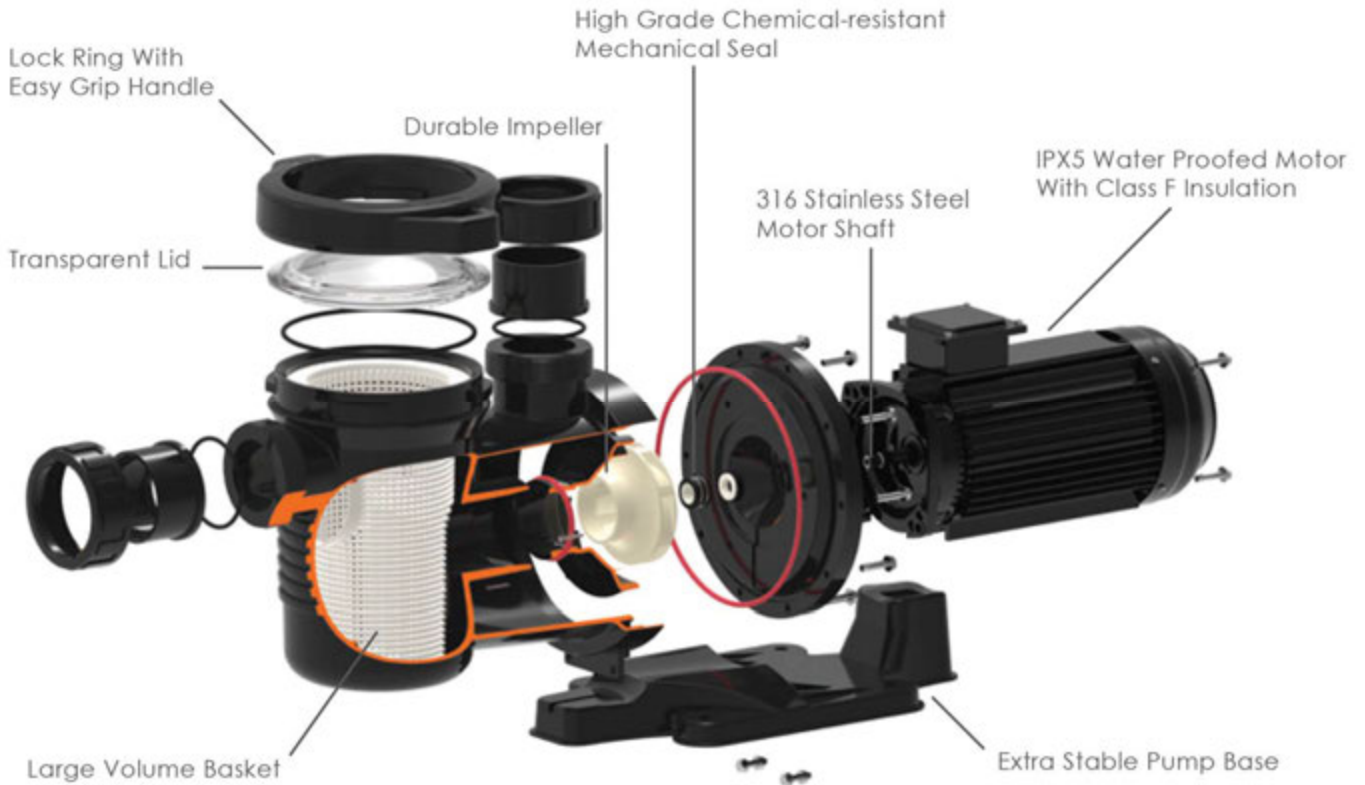

Product Information:

Model	Connection Size	Horsepower (hp)	Strainer Vol (L)	RPM	Input Power (kw)	Noise (dB)	Current (AMP)	Head (m)					
								8	10	12	14	16	18
								Flow Rate(m <sup>3</sup> /h)					
UPH400	3"/90mm	4	8	2850	3	70	5.5	64	62	53	42	30	---
UPH550	3"/90mm	5.5	8	2850	4	72	8	82	75	66	58	43	28
UPH700	3"/90mm	7	8	2850	5	72	10	96	90	82	72	60	45

Code	Model	In/Outlet (inches)	Flowrate (m <sup>3</sup> /h)	Head (m)	Noise (dB)	H.P.	V	Phase	Amp	Retail Price	Code✖
20700510495	UPH400	3	62	10	70	4.0	380	3	5.5	46,000.00	B ★
20700510500	UPH550	3	75	10	72	5.5	380	3	8.0	49,000.00	
20700510505	UPH700	3	90	10	72	7.0	380	3	10.0	54,000.00	

หมายเหตุ : ราคายังไม่รวมภาษี 7% บริษัทฯ ขอสงวนสิทธิ์ในการเปลี่ยนแปลงราคาโดยไม่ต้องแจ้งให้ทราบล่วงหน้า  
 Remarks : Excluded VAT 7%. The Company reserves the right to change the prices without announcement.



# “EMAUX” EPV Series Variable Speed Pumps Complete Set With Unions

## ROBUST AND RELIABLE LATEST HYDRAULIC DESIGN

Traditional single speed pump runs at maximum load continuously, inefficient and high running cost compared to the EMAUX EPV range. Reduced speed provides slower water circulation rates puts less strain on the complete installation such as filter, sanitization and plumbing. It reduces the wear and tear factor ending in saving to the home owner.

## FEATURES

- Energy Saving Pump, the power consumption of the pump is reduced 85%
- Advanced hydraulic design, water moves much more efficiently and the operation is whisper quite with the E-Power Variable speed pump operating at lower speeds
- One touch Controller
- Permanent Magnet Motor (PMM)
- Totally Enclosed Fan Cooled (TEFC)
- 5L Strainer Basket
- S.S. 316 Shaft
- S.S. 316 Mechanical Seal
- 2” / 2.5” Union Connection
- IPX5 Waterproof Standard
- Product Testing : 30,000 times cycling testing on high head in 50C water



- Super Quiet Operation
- Energy Saving
- User – Friendly Controller

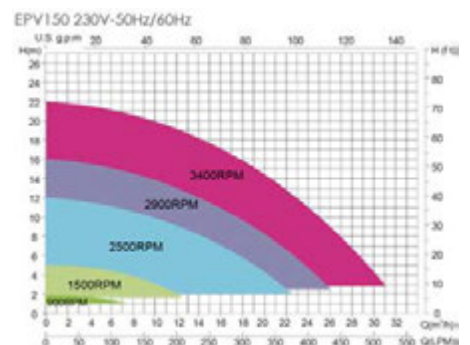
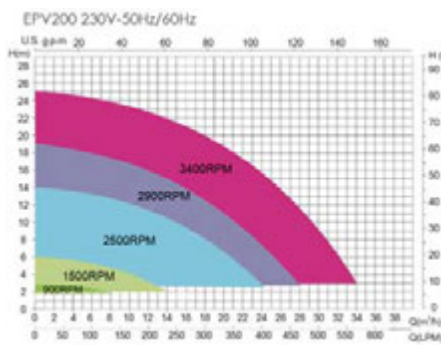
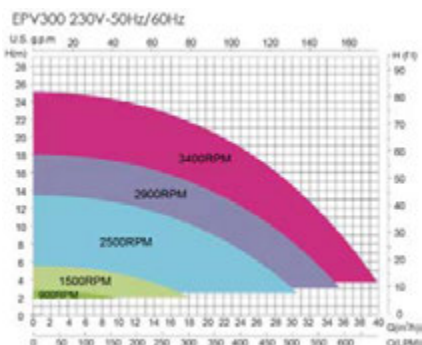
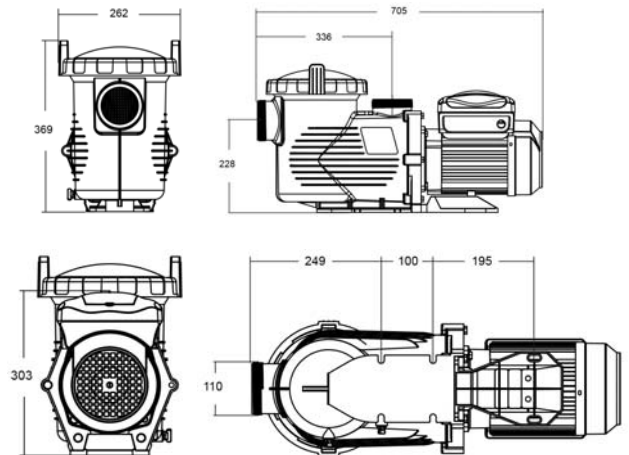



Model	In/Outlet (inches)	Flowrate (m3/h)				Head (m)			
		900rpm	1500rpm	2500rpm	2900rpm	900	1500	2500	2900
		(at 1m head)	(at 3m head)	(at 8m head)	(at 11m head)	rpm	rpm	rpm	rpm
EPV150	2/2.5	7.5m3 /hr	11m3 / hr	15m3 / hr	18m3 / hr	2m	5m	12m	16m

Model	In/Outlet (inches)	Flowrate (m3/h)				Head (m)			
		900rpm	1500rpm	2500rpm	2900rpm	900	1500	2500	2900
		(at 2m head)	(at 4m head)	(at 10m head)	(at 12m head)	rpm	rpm	rpm	rpm
EPV200	2/2.5	8m3 / hr	11m3 / hr	15m3 / hr	20m3 / hr	3m	6m	14m	19m
EPV300	2/2.5	9.5m3 / hr	13m3 / hr	20m3 / hr	25m3 / hr	3m	6m	14m	20m



**MODBUS**

- 1. RTU over RS-485
- 2. Support all standard Modbus protocol equipment
- 3. Isolated AB data bus
- 4. Max Baud Rate 9600bps

**EPV Series Variable Speed Pumps**

Code	Model	H.P.	Voltage	Phase	Noise (dB)	Weight (kg)	Retail Price	Code✕
20700510250	EPV150	1.5	220	1	52	23	50,500.00	B ★
20700510255	EPV200	2.0	220	1	53	24	57,900.00	
20700510260	EPV300	3.0	220	1	54	25	60,200.00	



**WI-FI CONNECTIVITY**

- 1. IEEE802.11, 2.4GHz, b/g/n
- 2. Internal antenna, open area 25m
- 3. Data throughput 300Mbits

**EPV Series Variable Speed Pumps with Wi-Fi**

Code	Model	H.P.	Voltage	Phase	Retail Price	Code✕
20700510470	EPV150-WIFI + RS485	1.5	220	1	55,700.00	B ★
20700510475	EPV200-WIFI + RS485	2.0	220	1	63,700.00	
20700510480	EPV300-WIFI + RS485	3.0	220	1	66,300.00	

หมายเหตุ : ราคายังไม่รวมภาษี 7% บริษัทฯ ขอสงวนสิทธิ์ในการเปลี่ยนแปลงราคาโดยไม่ต้องแจ้งให้ทราบล่วงหน้า  
 Remarks : Excluded VAT 7%. The Company reserves the right to change the prices without announcement.



# “EMAUX” SPV Series Variable Speed Pumps Complete Set With Unions

## ULTRA ENERGY EFFICIENCY

Emaux Super-Power Series Variable Speed Pump provides the best energy saving solution from over-usage and to increase efficiency and reduce maintenance cost

## FEATURES

- Permanent Magnet Motor (PMM)
- Totally Enclosed Fan Cooled (TEFC)
- Pump casing ABS + % glass filled, Impeller PPO (SABIC) Strainer basket and base in PP + % glass filled
- Motor shaft AISI316, Seals bellows-EPDM Stationary face-SIC rotating face-Graphite Spring ASIS316
- Super quite operation when running at the low RPM mode
- Designed and constructed to maximize the pump’s hydraulic performance

## WITH ADVANCED MENU

- One touch controller, the total control in your finger, pre-set speed programs, schedules, to have the most efficient pool, spa or any water feature connected
- Compatible with the future, LMCnet (EMAUX wireless management system)



RoHS COMPLIANT 2011/65/EU



SAA

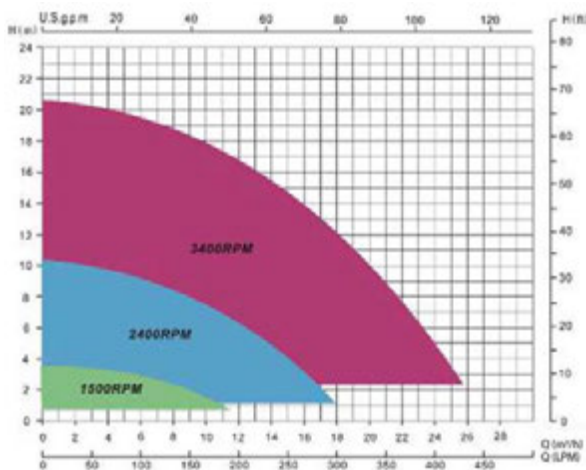
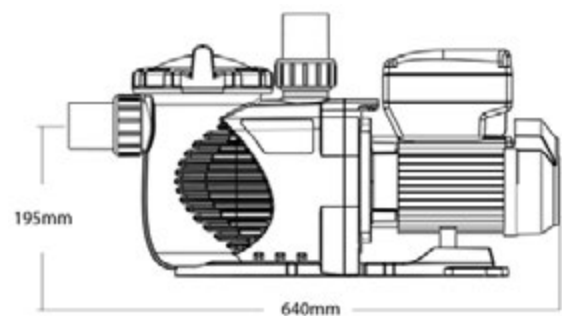
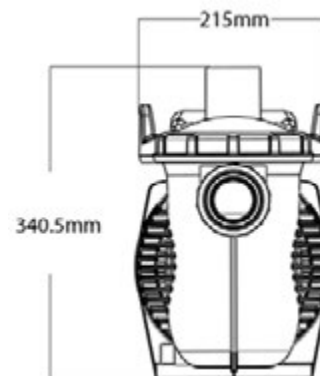





**PRODUCT FEATURES**

1. External control of Wi-Fi Direct (AP mode) or Home Network STA Mode
2. Permanent Magnet Motor (PMM), Totally Enclosed Fan Cooled (TEFC)
3. Pump casing ABS + glass fiber, Impeller PPO,
4. Strainer basket and base in PP + Glass fiber
5. Motor shaft - SS316, Seals bellows - EPDM, stationary face
6. SIC, rotating face - Graphite, Spring - SS316
7. Super quiet operation when running at low RPM mode
8. IPX Waterproof Standard



**MODBUS**

- |   |                          |
|---|--------------------------|
| 1. RTU over RS-485                                | 3. Isolated AB data bus  |
| 2. Support all standard Modbus protocol equipment | 4. Max Baud Rate 9600bps |

**SPV Series Variable Speed Pumps**

Code	Model	H.P.	V	Phase	In/Outlet (inches)	Flowrate (gpm)	Flowrate (m <sup>3</sup> /h)	Head (m)	Noise (dB)	Amp	Retail Price	Code ✖
20700510265	SPV150	1.5	220	1	1.5 & 2	88	20	10	53	5.0	36,000.00	B ★



**WI-FI CONNECTIVITY**

1. IEEE802.11, 2.4GHz, b/g/n
2. Internal antenna, open area 25m
3. Data throughput 300Mbits

**NEW CONNECTIVITY AND EXTERNAL CONTROL**

1. Wi-Fi Direct (AP mode) or Home Network STA Mode
2. RS485 communication port

**SPV Series Variable Speed Pumps with Wi-Fi**

Code	Model	H.P.	V	Phase	In/Outlet (inches)	Flowrate (gpm)	Flowrate (m <sup>3</sup> /h)	Head (m)	Noise (dB)	Amp	Retail Price	Code ✖
20700510490	SPV150- WIFI + RS485	1.5	220	1	1.5 & 2	88	20	10	53	5.0	39,900.00	B ★

หมายเหตุ : ราคายังไม่รวมภาษี 7% บริษัทฯ ขอสงวนสิทธิ์ในการเปลี่ยนแปลงราคาโดยไม่ต้องแจ้งให้ทราบล่วงหน้า  
 Remarks : Excluded VAT 7%. The Company reserves the right to change the prices without announcement.



# “EMAUX” SPH-2 Speed Series Residential Pool Pumps Complete Set With Unions

## ENGINEERED AND BUILT FOR POOL PROFESSIONALS

Known for its reputation for innovation and based on market feedback, Emaux has developed the SPH Series by answering a call from pool professionals for a reliable, economical pump for new installations and retrofits.

### FEATURES

1. Asynchronous, two-pole motor
2. Class insulation 155(F)
3. Thermal over current protection
4. Pump casing glass fiber reinforced ABS + Impeller PPO, Strainer basket and base in PP + glass fiber
5. Motor shaft - 316 stainless steel, seal bellows - EPDM, stationary face - SiC, rotating face - Graphite, Spring - 316 stainless steel
6. Self-Priming up to 3.3m above water level
7. Testing pressure 50 PSI (3.5 Bar)
8. Basket Volume 2 litres
9. IPX5 Waterproof Standard
10. Ring lock seal design eliminates leaks and maximizes suction efficiency

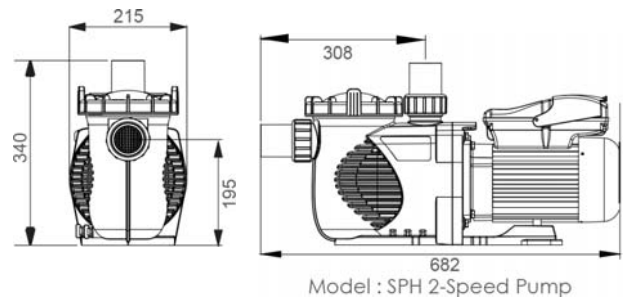
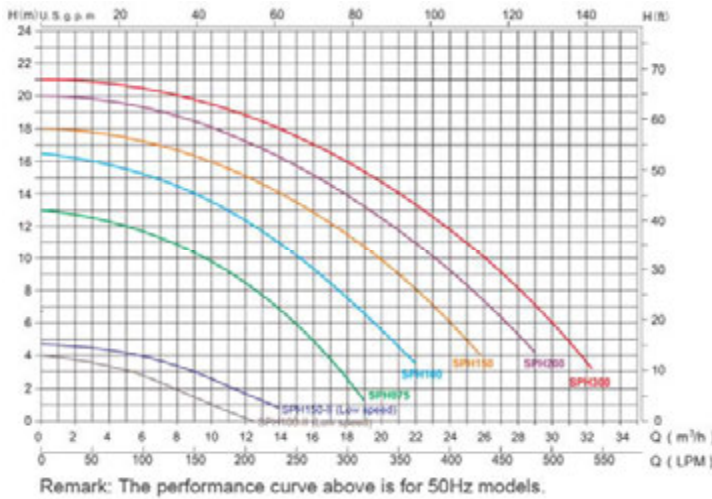

Model 50Hz	Input (kW)	Current (AMP)	Noise (dB)	Head (m)					
				6	8	10	12	14	16
SPH100-II (High Speed)	1.10	5	65	19.5	17.5	15.2	12.5	9	3
SPH100-II (Low Speed)	0.3	1.3	52	--	--	--	--	--	--
SPH150-II (High Speed)	1.50	6.8	65	24	22	19.9	17.5	14	10
SPH150-II (Low Speed)	0.35	1.5	52	--	--	--	--	--	--

Code	Model	In/Outlet (inches)	Flowrate (m³/h)	Head (m)	Noise (dB)	H.P.	Voltage	Phase	Retail Price	Code ✖
20700510510	SPH100-II	1.5 / 2	15.00	10	65	1.0	220	1	26,000.00	B ★
20700510515	SPH150-II	1.5 / 2	20.00	10	65	1.5	220	1	29,000.00	

หมายเหตุ : ราคายังไม่รวมภาษี 7% บริษัทฯ ขอสงวนสิทธิ์ในการเปลี่ยนแปลงราคาโดยไม่ต้องแจ้งให้ทราบล่วงหน้า  
 Remarks : Excluded VAT 7%. The Company reserves the right to change the prices without announcement.



# “EMAUX” EPH Series Commercial Pool Pumps Complete Set With Unions

## HIGH PERFORMANCE & HEAVY DUTY

For Residential & Semi-Commercial Pools

E-Power heavy duty pump delivers high flow and energy efficiency ultra performance. It is suitable for commercial swimming pool. 2 inch suction and discharge port with transparent lid. Ring lock seal design to eliminate suction leaks and to maximize suction efficiency



## AN EXCELLENT SELF-PRIMING PUMP

Ring lock seal design eliminate suction leaks and maximize suction efficiency

## FEATURES

- Asynchronous, Two Poles
- Class insulation: 130 (B)
- IPX5 Waterproof Standard
- Built-in thermal protection
- Overload protection
- S.S. 316 Shaft & Mechanical Seal
- Special design union compatible for both imperial and metric measurement standard
- Self-Priming up to 2.5 meters above water level
- Testing pressure 50 PSI (3.5 bar)
- Basket volume 5 litres

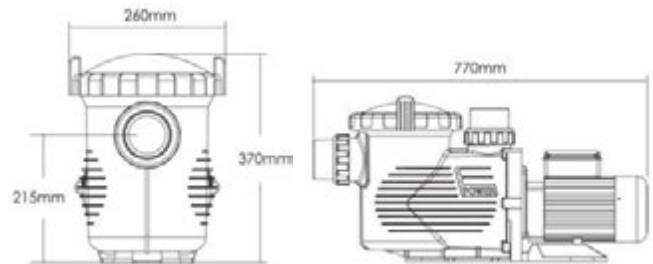
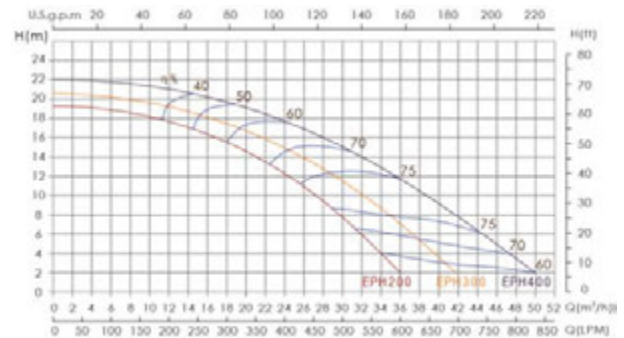

Code	Model	In/Outlet (inches)	Flowrate (gpm)	Flowrate (m³/h)	Head (m)	Noise (dB)	H.P.	V	Ph	KW	Amp	Weight (kg)	Retail Price	Code ✖
2024047061	EPH200-220	2 / 2.5	119	27.04	10	68	2.0	220	1	1.8	6.8	23.0	35,000.00	
20700510110	EPH200-380	2 / 2.5	119	27.04	10	68	2.0	380	3	1.8	3.9	23.0	35,000.00	
2024047062	EPH300-220	2 / 2.5	141	32.04	10	69	3.0	220	1	2.2	10.0	24.0	38,000.00	H★
20700510115	EPH300-380	2 / 2.5	141	32.04	10	69	3.0	380	3	2.2	5.7	24.0	38,000.00	
20700510120	EPH400-380	2 / 2.5	167	37.95	10	71	4.0	380	3	2.8	7.8	25.0	46,000.00	

หมายเหตุ : ราคายังไม่รวมภาษี 7% บริษัทฯ ขอสงวนสิทธิ์ในการเปลี่ยนแปลงราคาโดยไม่ต้องแจ้งให้ทราบล่วงหน้า  
Remarks : Excluded VAT 7%. The Company reserves the right to change the prices without announcement.



# “EMAUX” SB Series Semi-Commercial Pool Pumps Complete Set With Unions

## PROVEN THE MOST LONG-TERM DURABILITY PUMP

The SB Series pump delivers high flow and energy efficiency ultra performance. 2-inch suction and discharge port with transparent lid. Ring lock seal design to eliminate suction leaks and to maximize suction efficiency



## HIGHLIGHT FEATURES

- 2 inch suction and discharge port with transparent lid
- Ring lock lid design to eliminate suction leaks and maximize suction efficiency
- Asynchronous, Two Poles motor
- Class insulation: 130 (B)
- IPX5 Waterproof Standard
- Built-in thermal protection
- Overload protection
- Testing pressure 50 PSI (3.5 Bar)
- S.S. 316 Shaft & Mechanical Seal

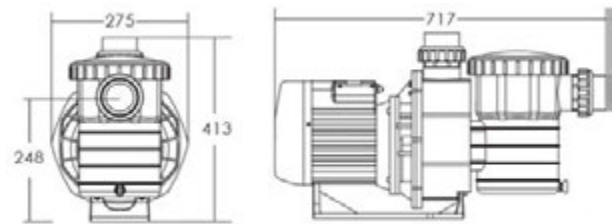

Model 50Hz	Input (kW)	Current (AMP)	Noise (dB)	Head (m)					
				6	8	10	12	14	16
SB10	0.97	4.7	67	16.4	14	11	7	--	--
SB15	1.30	5.9	67	24	22	19.5	16	12	2
SB20	1.80	8.2	69	31	28	25.2	22	18	12
SB30	2.18	10.5	69	34	32	28.4	26	23	19.2

Model	Connection Size	Horsepower	Weight(kg)	Capacitance 220V
SB10	2" / 63mm	1.0hp	16.0	25µF
SB15	2" / 63mm	1.5hp	17.0	25µF
SB20	2" / 63mm	2.0hp	23.0	30µF
SB30	2" / 63mm	3.0hp	24.0	35µF

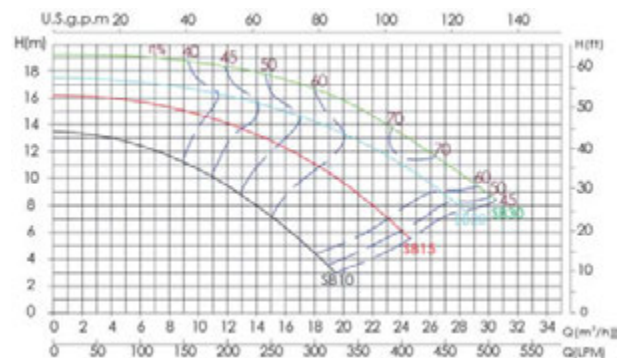

Code	Model	In/Outlet (inches)	Flowrate (gpm)	Flowrate (m³/h)	Head (m)	Noise (dB)	H.P.	V	Ph	Amp	Retail Price	Code ✳
20700510150	SB10	2	48.40	11.00	10	67	1.0	220	1	3.4	22,300.00	
20700510155	SB15	2	85.80	19.50	10	67	1.5	220	1	5.0	23,900.00	
20700510160	SB20	2	110.90	25.20	10	69	2.0	220	1	6.8	26,500.00	H★
20700510165	SB30-220	2	124.08	28.20	10	69	3.0	220	1	10.0	29,200.00	
20700510170	SB30-380	2	124.08	28.20	10	69	3.0	380	3	5.7	29,200.00	

หมายเหตุ : ราคายังไม่รวมภาษี 7% บริษัทฯ ขอสงวนสิทธิ์ในการเปลี่ยนแปลงราคาโดยไม่ต้องแจ้งให้ทราบล่วงหน้า  
Remarks : Excluded VAT 7%. The Company reserves the right to change the prices without announcement.



# “EMAUX” SPH Series Residential Pool Pumps Complete Set With Unions

## ENGINEERED AND BUILT FOR POOL PROFESSIONALS

Known for its reputation for innovation and based on market feedback, Emaux has developed the SPH Series by answering a call from pool professionals for a reliable, economical pump for new installations and retrofits.

### FEATURES

1. Asynchronous, two-pole motor
2. Class insulation 155(F)
3. Thermal over current protection
4. Pump casing glass fiber reinforced ABS + Impeller PPO, Strainer basket and base in PP + glass fiber
5. Motor shaft - 316 stainless steel, seal bellows - EPDM, stationary face - SIC, rotating face - Graphite, Spring - 316 stainless steel
6. Self-Priming up to 3.3m above water level
7. Testing pressure 50 PSI (3.5 Bar)
8. Basket Volume 2 litres
9. IPX5 Waterproof Standard
10. Ring lock seal design eliminates leaks and maximizes suction efficiency

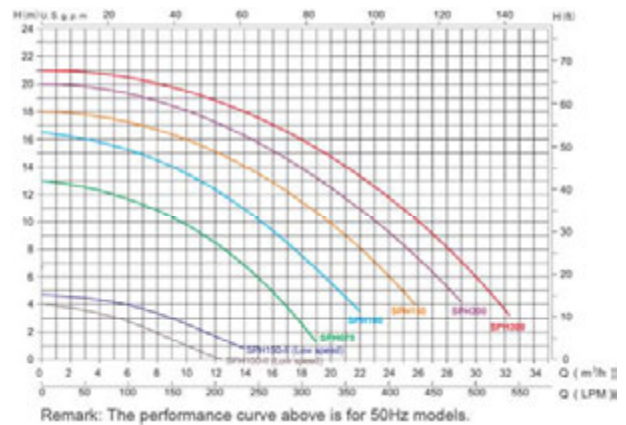
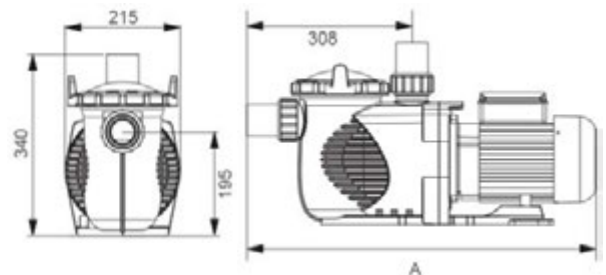

Model	Input (kW)	Current (AMP)	Noise (dB)	Head (m)					A (mm)	
				6	8	10	12	14		16
SPH075	0.75	3.5	65	15	12.5	9.5	5	--	--	652
SPH100	1.10	5	65	19.5	17.5	15.2	12.5	9	3	652
SPH150	1.50	6.8	67	24	22	19.9	17.5	14	10	652
SPH200	1.80	8.2	67	27.5	25.5	23	21.7	18	14.5	652
SPH300	2.20	10	68	30	28.5	26	23.8	21	18	682

Code	Model	In/Outlet (inches)	Flowrate (gpm)	Flowrate (m³/h)	Head (m)	Noise (dB)	H.P.	V	Ph	Amp	Retail Price	Code ✖
20700510125	SPH075	1.5 / 2	42	9.60	10	65	0.75	220	1	2.5	18,500.00	
20700510130	SPH100	1.5 / 2	66	15.00	10	65	1.0	220	1	3.4	19,800.00	
20700510135	SPH150	1.5 / 2	88	20.00	10	67	1.5	220	1	5.0	21,100.00	H ★
20700510140	SPH200	1.5 / 2	102	23.20	10	67	2.0	220	1	6.8	22,400.00	
20700510145	SPH300	1.5 / 2	114	26.00	10	68	3.0	220	1	10.0	23,800.00	

หมายเหตุ : ราคายังไม่รวมภาษี 7% บริษัทฯ ขอสงวนสิทธิ์ในการเปลี่ยนแปลงราคาโดยไม่ต้องแจ้งให้ทราบล่วงหน้า  
 Remarks : Excluded VAT 7%. The Company reserves the right to change the prices without announcement.



# “EMAUX” SC Series Residential Pool Pumps Complete Set With Unions

## FOR THE MEDIUM SIZE RESIDENTIAL POOLS

The SC pump is quiet running and energy efficient. 1.5-inch suction and discharge port with a transparent lid. It operates at a low decibel and energy consumption which requires minimal maintenance.



### HIGHLIGHT FEATURES

- 1.5 inch suction and discharge port with transparent lid
- Asynchronous, Two poles motor
- Class insulation: 130(B)
- IPX5 Waterproof standard
- Built-in thermal protection
- Overload protection
- External heat sink
- Available in 50Hz or 60Hz with 220V/110V
- Special design union compatible with both Imperial and Metric measurement standard
- Self-Priming up to 2m above water level
- Testing Pressure 50PSI (3.5 Bar)
- Basket Volume 2.5 litres
- S.S. 316 Shaft
- S.S. 316 Mechanical seal

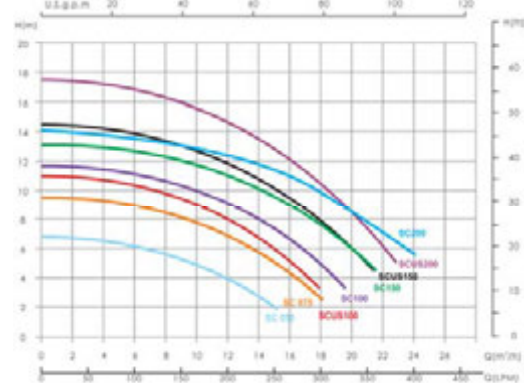
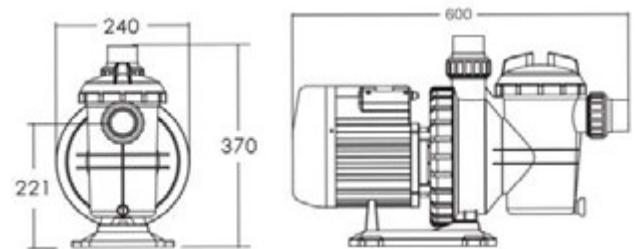

Code	Model	In/Outlet (inches)	Flowrate (gpm)	Flowrate (m <sup>3</sup> /h)	Head (m)	Noise (dB)	Amp	H.P.	V	Ph	Retail Price	Code ✖
20700510175	SC050	1.5	52.83	12.00	4	60	1.69	0.5	220	1	15,900.00	
20700510180	SC075	1.5	39.63	9.00	8	65	2.5	0.75	220	1	17,700.00	
20700510185	SC100	1.5	44.03	10.00	10	67	3.4	1.0	220	1	18,600.00	H ★
20700510190	SC150	1.5	61.64	14.00	10	68	5.0	1.5	220	1	19,900.00	
20700510195	SC200	1.5	79.25	18.00	10	69	6.8	2.0	220	1	21,200.00	

หมายเหตุ : ราคายังไม่รวมภาษี 7% บริษัทฯ ขอสงวนสิทธิ์ในการเปลี่ยนแปลงราคาโดยไม่ต้องแจ้งให้ทราบล่วงหน้า  
 Remarks : Excluded VAT 7%. The Company reserves the right to change the prices without announcement.



# “EMAUX” AMU Series Fountain Pumps With Timer & Complete Set With Unions

### FEATURES

- Attached with a –pre-filter with a transparent lid for easy maintenance
- Equipped with union connectors and flex hose adaptors
- Asynchronous, Two Poles
- Class insulation: 130 (B)
- IPX5 Waterproof Standard
- Built-in thermal protection
- External heat sink

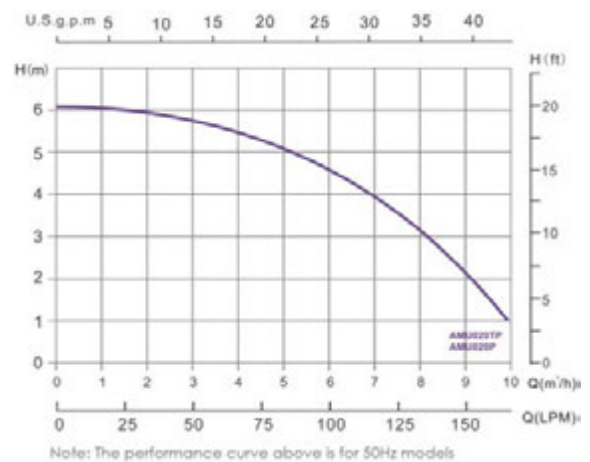
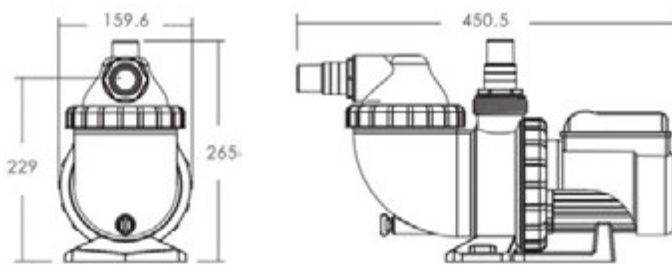

Model 50Hz	Input (kW)	Current (AMP)	Noise (dB)	Head (m)			
				2	3	4	5
AMU020TP	0.25	1.2	55	9.1	8.1	6.9	5.1

Model	Description	Horsepower	Connection Size	Adaptor	Weight (kg)
AMU020TP	0.20HP Aqua-Mini Pump (with timer & pre-filter)	0.2hp	1.5 inch 50mm	1 1/4" & 1 1/2" 32 & 38mm	4.2

Code	Model	In/Outlet (inches)	Flowrate (gpm)	Flowrate (m³/h)	Noise (dB)	H.P.	V	Ph	Amp	Retail Price	Code ✖
20700510240	AMU020TP	1.5	30	6.81	55	0.20	220	1	0.67	9,800.00	H★

หมายเหตุ : ราคายังไม่รวมภาษี 7% บริษัทฯ ขอสงวนสิทธิ์ในการเปลี่ยนแปลงราคาโดยไม่ต้องแจ้งให้ทราบล่วงหน้า

Remarks : Excluded VAT 7%. The Company reserves the right to change the prices without announcement.



# “ESPA” Silen I Series Complete Set With Unions Made In Spain

### APPLICATIONS

- Recirculation and filtering of water of small pools
- Very quiet-running (LWA 70-80dB)
- Self-priming up to 4m.

### MATERIALS

- Pump body, foot, impeller, seal mounting, diffuser, suction and discharge in techno polymer
- Pump shaft in AISI 431.
- ESPA mechanical seal
- Motor casing in aluminum
- O-ring in NBR



### MOTOR

- Asynchronous, 2 poles
- IP55 protection
- Class F insulation
- Thermal protection
- Continuous operation



### LIMITATIONS

- Maximum water temperature 40C

### EQUIPMENT

- No cable, no plug
- Imperial unions included 1.5”

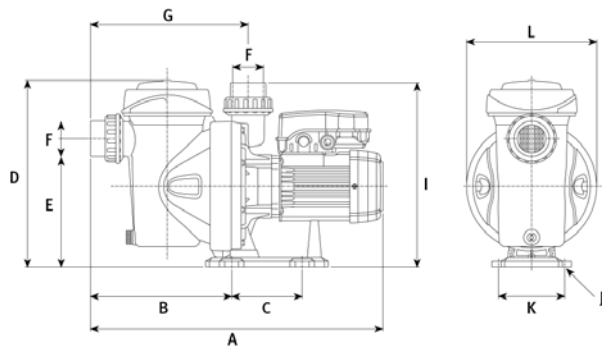

Performance curve at 2900 rpm

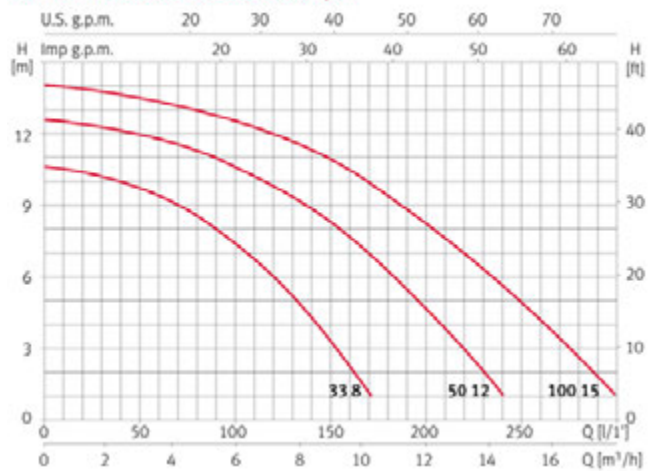

Dimension and weight

Model	A	B	C	D	E	F	G	I	J	K	L	Kg
Silen I 33	439	192	115	304	210	50	221	264	Ø9	108	212	8,9
Silen I 50	439	192	115	304	210	50	221	264	Ø9	108	212	10,2
Silen I 100	439	192	115	304	210	50	221	264	Ø9	108	212	10,9

Hydraulic performance table

Model	I [A]	P1 [kW]	P2		c [µF]	l/min	25	50	75	100	150	200	250	290	Code
	1~230V	1~	[kW]	[HP]			m³/h	1,5	3,0	4,5	6,0	9,0	12	15	
Silen I 33 8	2	0,45	0,25	0,33	12	m³/h	10,2	9,7	8,6	7,2	3,2	-	-	-	203144
Silen I 50 12	2,8	0,65	0,37	0,5	12	m³/h	12,3	11,9	11,3	10,5	8,1	4,6	-	-	203145
Silen I 100 15	3,8	0,85	0,75	1	12	m³/h	13,8	13,3	13	12,5	10,8	8,1	4,8	1,8	203146

Code	Model	In/Outlet (inches)	Flowrate (gpm)	Flowrate (m³/h)	Head (m)	Amp	H.P.	V	Ph	Retail Price	Code✳
20700530005	Silen I 33	1.5	11	2.5	10	1.11	0.33	220	1	16,900.00	K★
20700530010	Silen I 50	1.5	30.8	7	10	1.69	0.5	220	1	17,900.00	
20700530015	Silen I 100	1.5	46.2	10.5	10	3.4	1.0	220	1	19,200.00	

หมายเหตุ : ราคายังไม่รวมภาษี 7% บริษัทฯ ขอสงวนสิทธิ์ในการเปลี่ยนแปลงราคาโดยไม่ต้องแจ้งให้ทราบล่วงหน้า  
Remarks : Excluded VAT 7%. The Company reserves the right to change the prices without announcement.





# “ESPA” Silen S Series

## Complete Set With Unions Made In Spain

### APPLICATIONS

- Recirculation and filtering of water of medium pools
- Silent
- Self-priming up to 4m.

### MATERIALS

- Pump body, foot, impeller, seal mounting, diffuser, suction and discharge in techno polymer
- Pump shaft in AISI 431.
- ESPA mechanical seal
- Motor casing in aluminum
- O-ring in NBR.

### MOTOR

- Asynchronous, 2 poles
- IP55 protection
- Class F insulation
- Thermal protection
- Continuous operation

### LIMITATIONS

- Maximum water temperature 40°C

### EQUIPMENT

- No cable, no plug
- Imperial unions included 1.5”



Ultra-silent



Improved hydraulics



Self-priming up to 4m

## Dimension and weight

Model	A	B	C	D	E	F	G	H	I	J	L	Kg
Silen S 60	555	257	164	225	50	267	50	347	159	Ø9	238	8,9
Silen S 75	555	257	164	225	50	267	50	347	159	Ø9	238	10,2
Silen S 100	555	257	164	225	50	267	50	347	159	Ø9	238	10,9
Silen S 150	577	257	164	225	50	267	50	347	159	Ø9	238	13,5



Performance curve at 2900 rpm

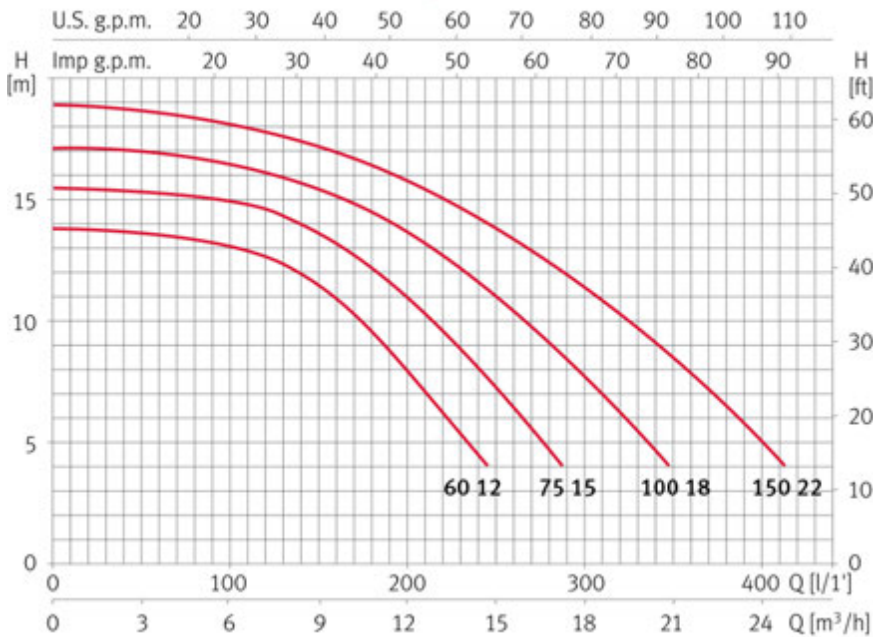

Hydraulic performance table

Model	I [A]			P1 [kW]		P2		ε [μF]	l/min	40	80	120	160	215	265	325	400	Code	
	1-230V	3-230V	3-400V	1-	3-	[kW]	[HP]											1-230V	3-230V/400V
Silen S 60 12	3.7	2.4	1.4	0.8	0.8	0.44	0.6	16	mwc	13.6	13.2	12.6	10.9	6.7	-	-	-	203147	203151
Silen S 75 15	5.5	3.3	1.9	1.2	1	0.55	0.75	16		15.2	15	14.5	13.1	9.9	6	-	-	203148	203152
Silen S 100 18	6	3.8	2.2	1.4	1.2	0.75	1	16		16.9	16.5	16	15	12.9	10	5.9	-	203149	203153
Silen S 150 22	7.1	4.8	2.8	1.6	1.6	1.1	1.5	25		18.6	18.2	17.7	16.9	15.1	13	10	5.1	203150	203154

Code	Model	In/Outlet (inches)	Flowrate (gpm)	Flowrate (m³/h)	Head (m)	Amp	H.P.	V	Ph	Retail Price	Code✳
20700530020	Silen S 60 (12M)	In 2 Out 1.5	46.2	10.5	10	2.0	0.6	220	1	21,900.00	K★
20700530140	Silen S 60 (12)	In 2 Out 1.5	46.2	10.5	10	1.17	0.6	380	3	21,900.00	
20700530025	Silen S 75 (15M)	In 2 Out 1.5	57.2	13	10	2.54	0.75	220	1	23,900.00	
20700530160	Silen S 75 (15)	In 2 Out 1.5	57.2	13	10	1.47	0.75	380	3	23,900.00	
20700530030	Silen S 100 (18M)	In 2 Out 1.5	70.4	16	10	3.39	1.0	220	1	26,900.00	
20700530170	Silen S 100 (18)	In 2 Out 1.5	70.4	16	10	1.96	1.0	380	3	26,900.00	
20700530035	Silen S 150 (22M)	In 2 Out 1.5	88	20	10	5.0	1.5	220	1	29,000.00	
20700530155	Silen S 150 (22)	In 2 Out 1.5	88	20	10	2.8	1.5	380	3	29,000.00	

หมายเหตุ : ราคายังไม่รวมภาษี 7% บริษัทฯ ขอสงวนสิทธิ์ในการเปลี่ยนแปลงราคาโดยไม่ต้องแจ้งให้ทราบล่วงหน้า  
 Remarks : Excluded VAT 7%. The Company reserves the right to change the prices without announcement.



# “ESPA” Silen S2 Series

## Complete Set With Unions Made In Spain

### APPLICATIONS

- Recirculation and filtering of water of large swimming pools
- Silent
- Self-priming up to 4m.

### MATERIALS

- Pump body, foot, impeller, seal mounting, diffuser, suction and discharge in techno polymer
- Pump shaft in AISI 431.
- ESPA mechanical seal
- Motor casing in aluminum
- O-ring in NBR.



Ultra-silent



Self-priming up to 4m

### MOTOR

- Asynchronous, 2 poles
- IP55 protection
- Class F insulation
- Thermal protection
- Continuous operation

### LIMITATIONS

- Maximum water temperature 40°C

### EQUIPMENT

- No cable, no plug
- Imperial unions included 1.5”

## Dimension and weight

Model	A	B	C	D	E	F	G	H	I	Kg
Silen S2 75	624	222	272	285	188	268	Ø13	63	327	14
Silen S2 100	624	222	272	285	188	268	Ø13	63	327	15
Silen S2 150	624	222	272	285	188	268	Ø13	63	327	18
Silen S2 200	624	222	272	285	188	268	Ø13	63	327	21
Silen S2 300	624	222	272	285	188	268	Ø13	63	327	23



Performance curve at 2900 rpm

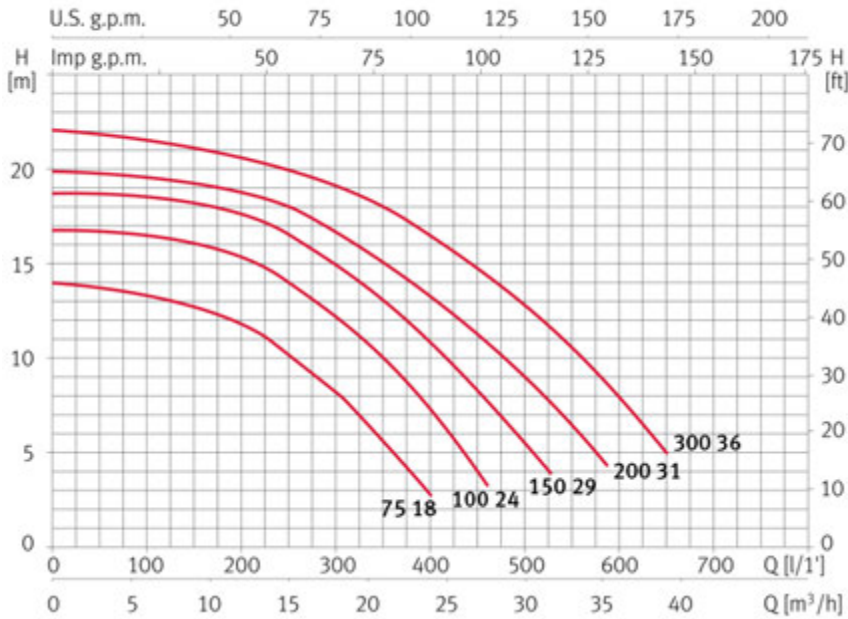

Hydraulic performance table

Model	I [A]			P1 [kW]		P2		c [µF]	l/ min m³/h	100	150	250	350	450	500	550	650	Code	
	1- 230V	3- 230V	3- 400V	1- 3-	3- [kW]	[HP]	6,0			9,0	15	21	27	30	33	39	1-230V	3-230V/400V	
Silen S2 75 18	4,5	3,8	2,2	1	1	0,55	0,75	25	mmHg	13,2	12,8	10	5,5	-	-	-	-	203155	203160
Silen S2 100 24	7	4,8	2,8	1,5	1,6	0,9	1,2	25		16,5	16	14,2	10	4	-	-	-	203156	203161
Silen S2 150 29	8,5	5,3	3,1	1,9	1,9	1,1	1,5	25		18,5	18,2	16,5	13	8,2	5,5	-	-	203157	203162
Silen S2 200 31	9,7	6,5	3,8	2,2	2,2	1,5	2	30		19,5	19,1	18	15	11,1	9	6,3	-	203158	203163
Silen S2 300 36	12,5	8,6	5	2,8	2,6	2,2	3	60		21,5	21	19,9	18	14,9	12,9	10,3	5	203159	203164

Code	Model	In/Outlet (inches)	Flowrate (gpm)	Flowrate (m³/h)	Head (m)	Amp	H.P.	V	Ph	Retail Price	Code✳
20700530040	Silen S2 75 (18m)	2	66	15	10	2.5	0.75	220	1	29,900.00	K★
20700530045	Silen S2 75 (18)	2	66	15	10	1.47	0.75	380	3	29,900.00	
20700530050	Silen S2 100 (24m)	2	92.4	21	10	3.39	1.0	220	1	31,900.00	
20700530055	Silen S2 100 (24)	2	92.4	21	10	1.96	1.0	380	3	31,900.00	
20700530060	Silen S2 150 (29m)	2	114.4	26	10	5.0	1.5	220	1	33,900.00	
20700530065	Silen S2 150 (29)	2	114.4	26	10	2.89	1.5	380	3	33,900.00	
20700530070	Silen S2 200 (31m)	2	123.3	28	10	6.8	2.0	220	1	35,900.00	
20700530075	Silen S2 200 (31)	2	123.3	28	10	3.94	2.0	380	3	35,900.00	
20700530080	Silen S2 300 (36m)	2	149.6	34	10	10.0	3.0	220	1	39,900.00	
20700530085	Silen S2 300 (36)	2	149.6	34	10	5.7	3.0	380	3	39,900.00	

หมายเหตุ : ราคายังไม่รวมภาษี 7% บริษัทฯ ขอสงวนสิทธิ์ในการเปลี่ยนแปลงราคาโดยไม่ต้องแจ้งให้ทราบล่วงหน้า  
 Remarks : Excluded VAT 7%. The Company reserves the right to change the prices without announcement.



# “ESPA” Nadorsel Series

## Swim Jet Pumps Complete Set With Unions Made In Spain

### APPLICATIONS

- Generate a strong stream of water and transform swimming pools into places for sport and leisure
- Silent
- Self-priming up to 4m.

### MATERIALS

- Pump body, foot, impeller, seal mounting, diffuser, suction and discharge in techno polymer
- Pump shaft in AISI 431.
- ESPA mechanical seal
- Motor casing in aluminum
- O-ring in NBR.

### MOTOR

- Asynchronous, 2 poles
- IP55 protection
- Class F insulation
- Thermal protection
- Continuous operation

### LIMITATIONS

- Maximum water temperature 40°C

### EQUIPMENT

- No cable, no plug
- Imperial unions included 1.5”



Performance curve at 2900 rpm

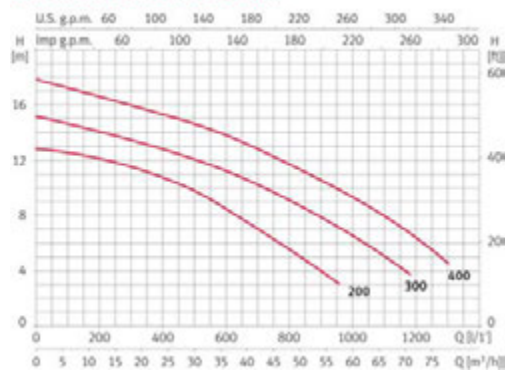

Dimension and weight

Model	A	B	C	D	E	F	G	H	I	Kg
Nadorsel 200	416	335	615	130	249	419	70	210"	47	25.1/23.1
Nadorsel 300	416	335	615	130	249	419	70	210"	47	26.1/25.8
Nadorsel 400	416	335	615	130	249	419	70	210"	47	28

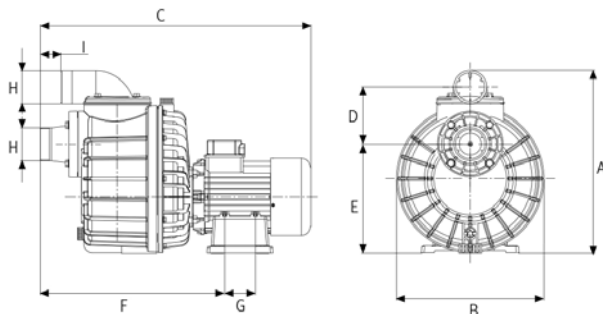

### Hydraulic performance table

Model	I [A]			P1 [kW]		P2		c [µF]	l/min m³/h	100	200	400	600	800	1000	1200	1300	Code	
	1-230V	3-230V	3-400V	1-	3-	[kW]	[HP]			6.0	12	24	36	48	60	72	78	1-230V	3-230V/400V
Nadorsel 200	10,2	7	4,1	2,2	2,2	1,5	2	40	12,9	12,2	10,6	8,5	6	-	-	-	-	203165	203167
Nadorsel 300	13,4	8,6	5	3	3	2,2	3	60	14,6	14	12,8	11,3	9	6,5	-	-	-	203166	203168
Nadorsel 400	-	11,8	6,8	-	3,4	3	4	-	17,2	16,6	15,3	13,8	11,6	9,4	6,3	4,5	-	-	203169

Code	Model	In/Outlet (inches)	Flowrate (gpm)	Flowrate (m³/h)	Head (m)	Amp	H.P.	V	Ph	Retail Price	Code✘
20700530120	Nadorsel 200 M	2.5	128	29	10	6.8	2.0	220	1	53,000.00	K★
20700530125	Nadorsel 200	2.5	128	29	10	3.9	2.0	380	3	53,000.00	
20700530130	Nadorsel 300	2.5	194	44	10	5.7	3.0	380	3	54,000.00	
20700530135	Nadorsel 400	2.5	251	57	10	7.8	4.0	380	3	56,000.00	

หมายเหตุ : ราคายังไม่รวมภาษี 7% บริษัทฯ ขอสงวนสิทธิ์ในการเปลี่ยนแปลงราคาโดยไม่ต้องแจ้งให้ทราบล่วงหน้า

Remarks : Excluded VAT 7%. The Company reserves the right to change the prices without announcement.



# “EMAUX” ST Series Jet Pumps Complete Set With Unions

**FOR THE ABOVE-GROUND POOLS OR PORTABLE SPAS**

ST Series Pump has the option to have the pre-filter disassembled which allows users a greater degree of applications. 1.5-inch suction and discharge port with a transparent lid. It operates at a low decibel and energy consumption which requires minimal maintenance.

**FEATURES**

- Asynchronous, Two poles motor
- Class insulation: 130(B)
- IPX5 Waterproof standard
- Built-in thermal protection
- External heat sink
- Available in 50Hz or 60Hz with 220V/110V
- Special design union compatible for both Imperial and Metric measurement standard
- S.S. 316 Shaft & Mechanical Seal

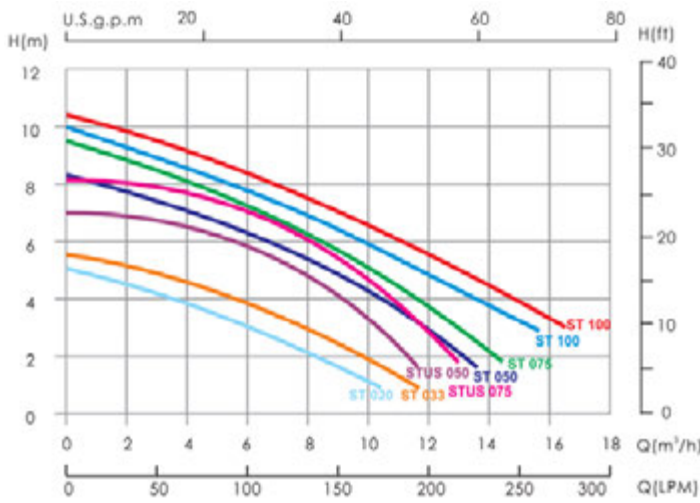

Remark: The performance curve above is for 50Hz models

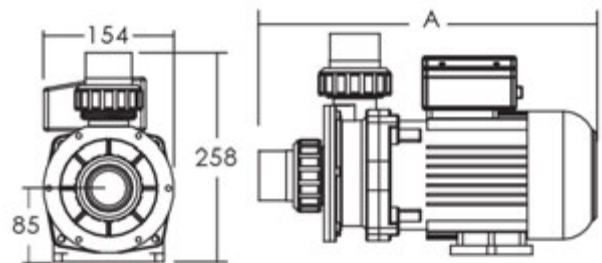

Model	Input (kW)	Current (AMP)	Noise (dB)	Head (m)			
				2	4	6	8
ST050	0.55	2.5	60	13.2	10.3	6.6	1
ST075	0.75	3.5	60	14.4	11.3	8.6	4
ST100	0.90	4.7	65	17	13.6	9.8	5.1

Code 220V/50Hz	Code 220V/60Hz	Code 110V/60Hz	Code 115V/60Hz	Model	Connection Size	Horsepower	Weight (kg)	Capacitance 220V	Capacitance 110V	Capacitance 115V	A mm
88023003	88023103	88023203	/	ST050	1.5" / 50mm	0.5hp	7.3	8µF	30µF	/	375
88023004	88023104	88023204	/	ST075	1.5" / 50mm	0.75hp	8.2	14µF	40µF	/	375
88023005	88023105	88023205	/	ST100	1.5" / 50mm	1.0hp	9.1	20µF	60µF	/	375

Code	Model	In/Outlet (inches)	Flowrate (gpm)	Flowrate (m³/h)	Head (m)	Noise (dB)	H.P.	V	Ph	Amp	Retail Price	Code✘
20700510305	ST050	1	40	9.09	5	65	0.5	220	1	2.5	12,700.00	H★
20700510310	ST075	1	50	11.36	5	65	0.75	220	1	3.4	14,000.00	
20700510315	ST100	1	58	13.18	5	65	1.0	220	1	4.0	15,200.00	

หมายเหตุ : ราคายังไม่รวมภาษี 7% บริษัทฯ ขอสงวนสิทธิ์ในการเปลี่ยนแปลงราคาโดยไม่ต้องแจ้งให้ทราบล่วงหน้า  
Remarks : Excluded VAT 7%. The Company reserves the right to change the prices without announcement.



# “EMAUX” SR Series Jet Pumps Complete Set With Unions

## FOR THE ABOVE-GROUND POOLS OR PORTABLE SPAS

The SR Series pump is the right choice for both high and medium head installation in commercial spa pools. The seal and bearing used are imported from trustable suppliers to ensure reliable quality. It delivers high flow and energy efficiency ultra performance.

### FEATURES

- Asynchronous, Two poles motor
- Class insulation: 130(B)
- IPX5 Waterproof standard
- Built-in thermal protection
- External heat sink
- Available in 50Hz or 60Hz with 220V/380V
- Special design union compatible for both Imperial and Metric measurement standard
- S.S. 316 Shaft & Mechanical Seal

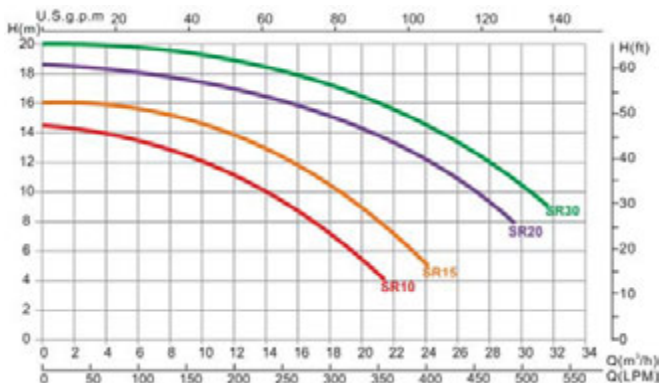
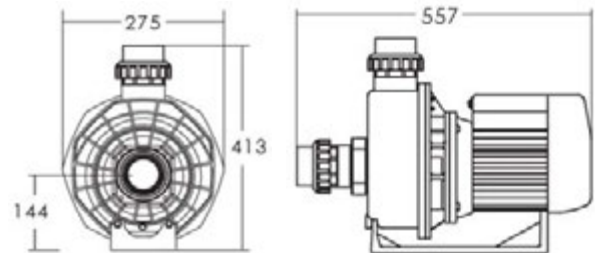

Model	Input (kW)	Current (AMP)	Noise (dB)	Head (m)					
				6	8	10	12	14	16
SR10	0.97	4.7	67	19.6	17	14	10	4	--
SR15	1.30	5.9	67	23.2	21	18.8	14.8	11.6	2
SR20	1.80	8.2	69	31	29.2	27	24	20.5	16
SR30	2.18	10.5	69	34	32	30.5	28	25	21

Model	Connection Size	Horsepower	Weight (kg)	Capacitance 220V
SR10	2" / 63mm	1.0hp	14.70	25µF
SR15	2" / 63mm	1.5hp	16.30	25µF
SR20	2" / 63mm	2.0hp	19.70	30µF
SR30	2" / 63mm	3.0hp	22.10	35µF

Code	Model	In/Outlet (inches)	Flowrate (gpm)	Flowrate (m³/h)	Head (m)	Noise (dB)	H.P.	V	Ph	Amp	Retail Price	Code✘
20700510280	SR10	2	61.60	14.00	10	67	1.0	220	1	3.39	20,900.00	H★
20700510285	SR15	2	81.40	18.50	10	67	1.5	220	1	5.0	22,300.00	
20700510290	SR20	2	121.00	27.50	10	69	2.0	220	1	6.8	24,900.00	
20700510295	SR30-220	2	135.52	30.80	10	69	3.0	220	1	10.0	27,900.00	
20700510300	SR30-380	2	135.52	30.80	10	69	3.0	380	3	5.7	27,900.00	

หมายเหตุ : ราคายังไม่รวมภาษี 7% บริษัทฯ ขอสงวนสิทธิ์ในการเปลี่ยนแปลงราคาโดยไม่ต้องแจ้งให้ทราบล่วงหน้า  
 Remarks : Excluded VAT 7%. The Company reserves the right to change the prices without announcement.



# “EMAUX” AB Series Economy Air Blower

## CREATE BUBBLE STREAM TO YOUR POOL

For both commercial and portable spa

With low energy consumption, AB Series Economy Air Blower offers high-efficiency operation in a compact design that fits for limited space installation.



### FEATURES

- Air blower is applicable in bath tub or spa tub, with 350W motors

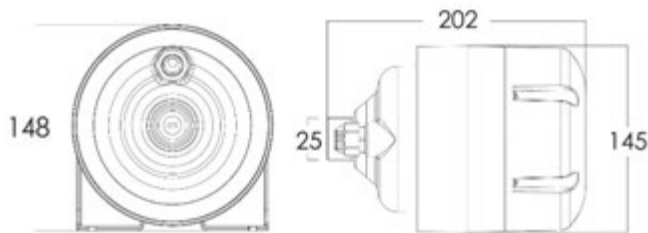

Code	Model	Description	Retail Price	Code✖
20360510095	AB550	500W	4,900.00	H★



หมายเหตุ : ราคายังไม่รวมภาษี 7% บริษัทฯ ขอสงวนสิทธิ์ในการเปลี่ยนแปลงราคาโดยไม่ต้องแจ้งให้ทราบล่วงหน้า  
Remarks : Excluded VAT 7%. The Company reserves the right to change the prices without announcement.





# “GREENCO” Commercial Air Blowers Complete Set With Unions

## FEATURES

- All 2RB achieve the standards and norms of the low voltage directive (LVD) 2006/95/EC, rotating electro technical motor EN 60034-1-2004, electromagnetic compatibility (EMC) EN55014-1/2, EN61000-2/-3/-4/-6
- For standard UL for ELECTRIC MOTOR UL 1004-1
- Relief-valve are available for limiting differential pressure
- Measuring-surface sound-pressure level ac. To DIN EN 21680, measured at a distance of 1 m. the pump is throttled to an average suction pressure, a hose is connected to the discharge side (compressor) / suction side (vacuum pump), but is not fitted with relief valves.
- The motor are designed according to the DIN EN 60 034 / DIN IEC 34-1 and temperature class F



Code	Model	In/Outlet (inches)	Max Flowrate (m <sup>3</sup> /hr)	Sound Pressure Level (dB)	Amp	In/Outlet (inches)	H.P.	V	Ph	Retail Price	Code✳
20800700005	2RB 410-7AA11	1.5	145	63	3.39	1.5	1.0	220	1	26,500.00	
20800700010	2RB 510-7AA11	2	210	64	5.0	2	1.5	220	1	27,700.00	
20800700015	2RB 510-7AA21	2	210	64	6.8	2	2.0	220	1	31,100.00	
20800700020	2RB 610-7AH16	2	220	69	5.7	2	3.0	380	3	41,500.00	H★
20800700025	2RB 710-7AH26	2	318	69	7.8	2	4.0	380	3	55,400.00	
20800700030	2RB710-7AH37	2	318	69	9.7	2	5.0	380	3	91,200.00	
20800700035	2RB 810-7AH17✳	2.5	530	70	14.4	2.5	7.5	380	3	112,000.00	
20800700040	2RB 810-7AH27✳	2.5	530	70	19.7	2.5	10.0	380	3	137,000.00	

✳ สินค้าไม่มีสต็อก กรุณาสั่งล่วงหน้า 60-90 วัน / No Stock, Delivery Time 60-90 Days

หมายเหตุ : ราคายังไม่รวมภาษี 7% บริษัทฯ ขอสงวนสิทธิ์ในการเปลี่ยนแปลงราคาโดยไม่ต้องแจ้งให้ทราบล่วงหน้า  
Remarks : Excluded VAT 7%. The Company reserves the right to change the prices without announcement.



“HAYWARD” Pumps



Super II Series Complete Set With Unions

Code	Model	In/Outlet (inches)	Flowrate (gpm)	Flowrate (m <sup>3</sup> /h)	Head (m)	H.P.	V	Ph	Amp	Retail Price	Code✳
20700800035	SP3007X1051	1.5	65	14.77	10	1.0	220	1	3.39	42,900.00	I
20700800040	SP3010X1551	2	85	19.32	10	1.5	220	1	5.0	44,900.00	
20700800045	SP3015X2051	2	103	23.41	10	2.0	220	1	6.8	53,900.00	
20700800050	SP3025X30G51	2	150	34.09	10	3.0	220	1	10.0	66,200.00	
20700800055	SP303053	2	150	34.09	10	3.0	380	3	5.78	77,900.00	



Super Pump Series Complete Set With Unions

Code	Model	In/Outlet (inches)	Flowrate (gpm)	Flowrate (m <sup>3</sup> /h)	Head (m)	H.P.	V	Ph	Amp	Retail Price	Code✳
20700800060	SP2605X751	1.5	50	11.36	10	3/4	220	1	2.54	34,950.00	I
20700800065	SP2607X1051	1.5	62	14.09	10	1.0	220	1	3.39	37,900.00	
20700800070	SP2610X1551	1.5	72	16.36	10	1.5	220	1	5.0	41,950.00	
20700800075	SP2616X2051	2	107	24.32	10	2.0	220	1	6.8	49,550.00	

หมายเหตุ : ราคายังไม่รวมภาษี 7% บริษัทฯ ขอสงวนสิทธิ์ในการเปลี่ยนแปลงราคาโดยไม่ต้องแจ้งให้ทราบล่วงหน้า  
 Remarks : Excluded VAT 7%. The Company reserves the right to change the prices without announcement.



# DISINFECTION SYSTEMS





# “NAKED” Freshwater Pool Systems Made In Australia

- ระบบเฟรชวอเตอร์พูล** เป็นระบบไฮบริดที่แท้จริงที่ทำให้น้ำในสระใสสะอาดเหมือนน้ำดื่ม ซึ่งมีข้อดีมากมายและมีคุณภาพน้ำดีที่สุดในตอนนี้

The Naked System is a TRUE Hybrid Freshwater System offering plenty of benefits and the best possible water quality
- ให้น้ำใส สดชื่น เหมาะแก่การออกกำลังกาย และบำบัดร่างกาย**

Delivers rejuvenating & refreshing crystal clear fresh water.
- ลูกค้ามีตัวเลือกใหม่ที่เพิ่มขึ้น** นอกจากคลอรีน น้ำเกลือ และน้ำแร่

Consumers are becoming more aware that there are alternatives on the market to chlorine and that salt or mineral pools are actually chlorinated pools.
- เหมาะแก่ผู้ที่ผิวแพ้ง่ายและเป็นหอบหืด**

Skin and asthma allergies are increasingly important to families.
- การใช้ระบบเฟรชวอเตอร์พูลนั้นเหมาะสำหรับผู้ตระหนักถึงปัญหาสิ่งแวดล้อมเพราะน้ำที่ผ่านระบบสะอาดไม่มีผลกระทบต่อธรรมชาติ**

Environmental concerns are equally as important.



Most awarded system



## Typical Equipment Installation

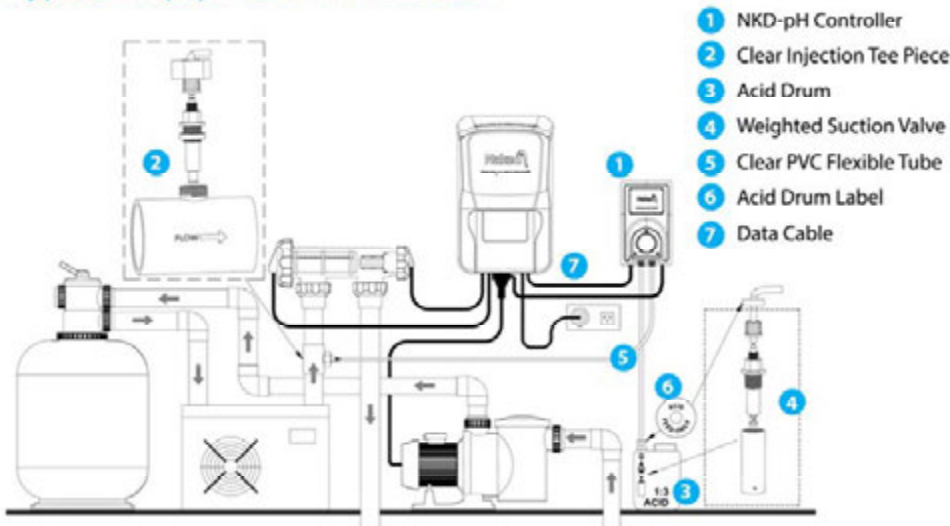

Option : Naked pH Controller



Pool Size (Litres)

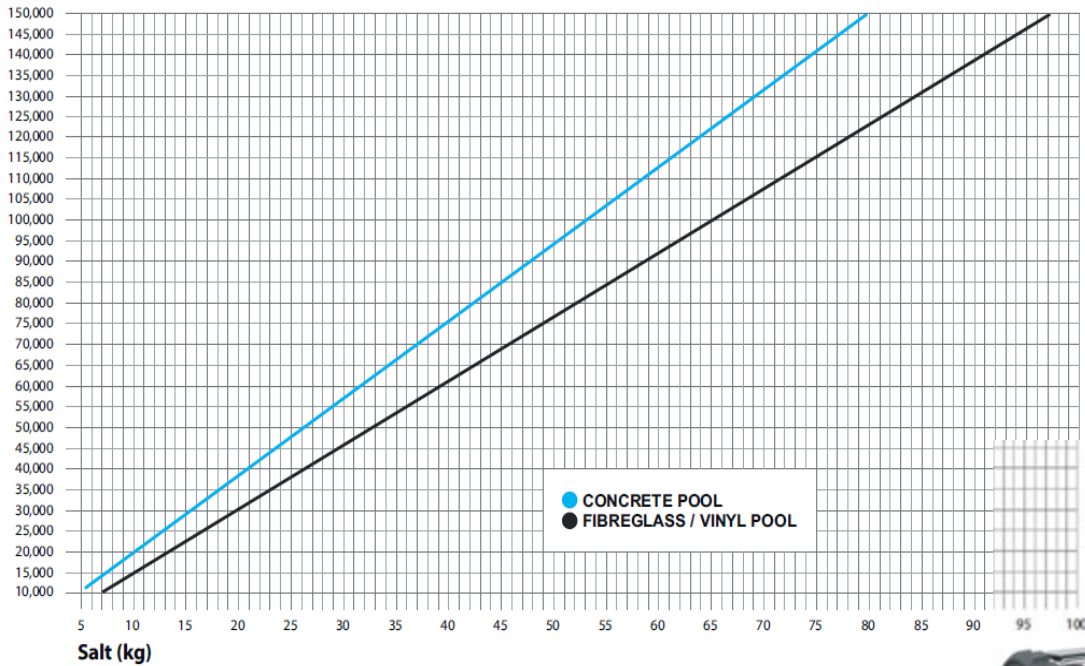

Table above for start up salt quantity for pool volume



NKD – Naked Freshwater System

Code	Model	Gram/Hour	Pool Volume (m <sup>3</sup> )	Pool Type	Warranty (Except Copper Rod)	Retail Price	Code✳
20701420005	NKD-R	15	5 – 150	Residential Pool	3 Years	111,000.00	B ★
20701420010	NKD-C	30	5 – 150	Commercial Pool	2 Years	199,000.00	

Specifications

Volts Input (Vac)	220-245
Amps Input - Max. (Aac)	1.00
Total Power Consumption (W)	13W Motor - 20W Total
Frequency (Hz)	50
pH Controller Dimensions (mm)	135W x 225H x 123D
Output Controlled by Sanitiser (LPH)	0-1.0
Rated Pressure (kPa)	350
Squeeze Tube	Tygon® Norprene® (Commercial spec)
Motor Speed (RPM)	10
Non-Return Injector Valve	PVC with viton sleeve
Tubing	6m x 6mm Clear PVC Flexible Tube
Roller Block	Heavy-duty PVC
Power Cord	Approved piggy-back type
Water Connection	40/50mm
Water Flow Rate (L/min)	80-650
IP Rating	34
Net Weight (kg)	2.5



NKD-pH Controller

Code	Model	Retail Price	Code✳
20711420440	NKD-pH Controller	29,900.00	B ★

หมายเหตุ : ราคายังไม่รวมภาษี 7% บริษัทฯ ขอสงวนสิทธิ์ในการเปลี่ยนแปลงราคาโดยไม่ต้องแจ้งให้ทราบล่วงหน้า  
 Remarks : Excluded VAT 7%. The Company reserves the right to change the prices without announcement.



# “OZONESWIM” Salt Chlorinator With Ozone Made In Australia

คำถาม ... โอโซนกับคลอรีน ฆ่าไวรัสต่างกันยังไง ? ...

พวกเขาสามารถฆ่าไวรัสตัวเดียวกัน แต่โอโซนทำเร็วกว่า 3000 เท่า นั่นหมายความว่าคนว่ายน้ำมีโอกาสน้อยมากที่จะได้สัมผัสกับไวรัสเพราะมันถูกฆ่าตายเร็วกว่า 3000 เท่าของความสามารถในการเอาชีวิตรอดในน้ำ และสัมผัสกับ คนว่ายน้ำ

### ABOUT THE SYSTEM

Ozone is a naturally occurring oxidiser that is a powerful sanitising agent and is used throughout many industries to purify air and water. Ozone Swim combines patented corona discharge technology with a premium mineral/salt chlorination system. Therefore it effectively sanitises, purifies and reduces maintenance - resulting in therapeutic, healthy and crystal clear water.



Proudly Australian Made with Environment and Innovation Awards

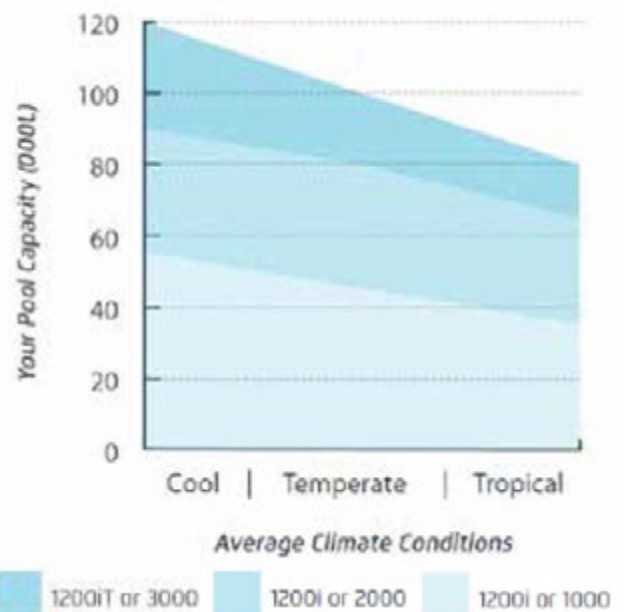



## OZONE SYSTEM

### Mineral/Salt + Ozone = Total Solution

The 1000, 2000 & 3000 Series is designed to replace existing sanitisation systems. These units have the benefit of both salt/mineral Chlorination and Ozone purification.

<b>BR-500.07</b>	<b>Ozone Swim 1000 Series</b>
Salt/Mineral Level:	3,500ppm
<b>BR-500.08</b>	<b>Ozone Swim 2000 Series</b>
Salt/Mineral Level:	3,500ppm
<b>BR-500.09</b>	<b>Ozone Swim 3000 Series</b>
Salt/Mineral Level:	3,500ppm

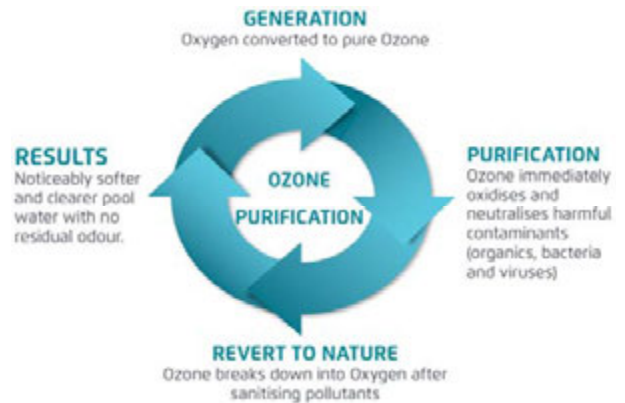

## A New Benchmark in Reliability, Convenience & Control



### Ultimate Dual Sanitation & Purification

Combining Ozone & Chlorine delivers the total solution.



### Self-Cleaning Cell Technology

Keeps your system clean and reduces maintenance.



### Multi-Flow Ozone Injection Manifold

Automatic, safe and consistent Ozone dosing.



### Mineral, Salt or Fresh Water Compatible

Compliments any residual sanitisation system.

Ozone Production 1.0 – 1.2 grams per hour

Start up salt quantity is 4 kgs per 1 m<sup>3</sup> volume of water

Code	Model	Gram/Hour	Power Consumption (Watt)	Pool Volume (m <sup>3</sup> )	Retail Price	Code✖
20901510005	Ozone Swim 1000	15	216	30 - 50	86,900.00	B ★
20901510010	Ozone Swim 2000	25	265	50 - 70	91,900.00	
20901510015	Ozone Swim 3000	35	315	70 - 90	99,900.00	

หมายเหตุ : ราคายังไม่รวมภาษี 7% บริษัทฯ ขอสงวนสิทธิ์ในการเปลี่ยนแปลงราคาโดยไม่ต้องแจ้งให้ทราบล่วงหน้า  
 Remarks : Excluded VAT 7%. The Company reserves the right to change the prices without announcement.





# “EMAUX” SSC-mini Series Residential Salt Chlorinator

## SIMPLY RELIABLE

New Salt Chlorinator engineered for residential pools up to 90,000 liters

The new SSCmini salt chlorinator incorporates the latest technology, and intuitive interface and robust components to create the most reliable, user friendly and maintenance free chlorinator with the best value for money in the market.

## ADVANTAGE

- User friendly: Easy operations with few buttons
- Clear indications and alerts: End cell lifetime, No flow, General problems alarm
- Easy installation: Minimum piping modifications for existing installations.
- Cell wiring already fixed in the cell the avoid connection trouble
- Long cell lifetime and economic spare part available
- Less handling of chemicals and better quality of water

## THE CELL

The cell is composed by:

- Titanium plates for a maximum chlorine production of 25 gram/hour
- Self-cleaning reverse polarity
- Flow switch
- Temperature sensor
- Translucent casing with two different connections: 50 mm / 1 1/2" or 63 mm / 2"
- Maximum working pressure: 2.5 bar
- Perfect suited for magnesium salted pools



## CONTROL PANEL

Intuitive control panel allows you to control:

- The time production
- Super-chlorinator It also indicates:
- End of the expected cell life
- No flow
- Chlorine generation
- Stand-by model
- General problem alarm



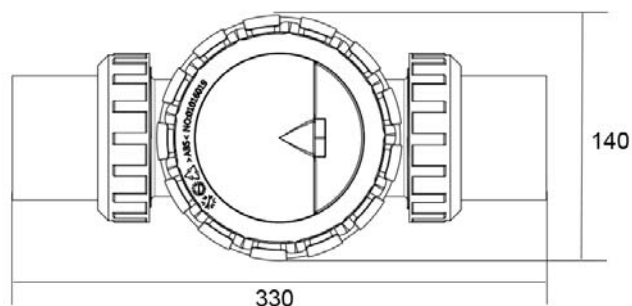
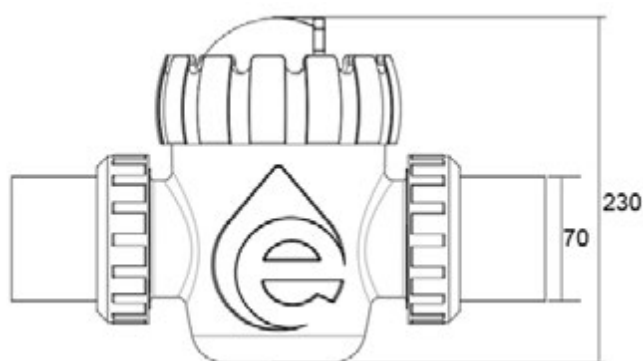
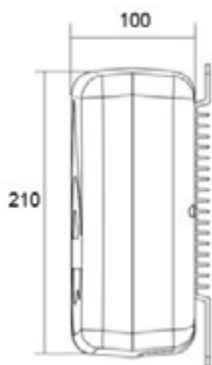
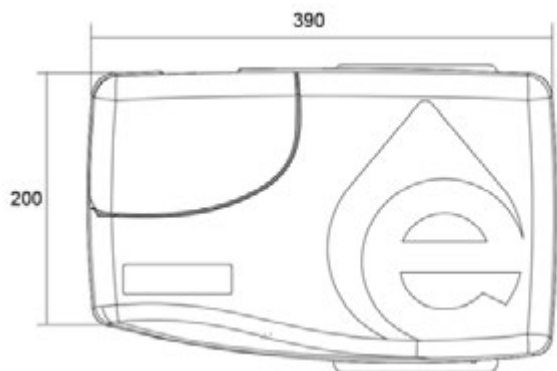

Model	Input Voltage/ Frequency	Salt Level	Cell Output	Maximum Pool Size	Cell Connections
SSCmini	220-240V / 50-60Hz	3000ppm	20gr/hr	90,000 Liters	1.5" / 50mm or 2" / 63mm

Standard Range of Salt Level in the Pool : 3500 – 4000 ppm

Commissioning Pool : Salt quantity is 3.5 - 4 Kg/m<sup>3</sup>

Maintenance Pool to maintain CL level at 1.5-2 ppm: Salt quantity is 3.5 – 4 Kg/m<sup>3</sup>

Code	Model	Water Capacity (m <sup>3</sup> )	Gram/Hour	Power Consumption (Watts)	Retail Price	Code✖
20900510095	SSC-mini	90	20	150	42,000.00	H★

หมายเหตุ : ราคายังไม่รวมภาษี 7% บริษัทฯ ขอสงวนสิทธิ์ในการเปลี่ยนแปลงราคาโดยไม่ต้องแจ้งให้ทราบล่วงหน้า  
Remarks : Excluded VAT 7%. The Company reserves the right to change the prices without announcement.



# “EMAUX” SSC Series Semi-Commercial Salt Chlorinators

Salt Chlorinators, are an alternative means of sanitizing your pool with chlorine using the process of electrolysis. The electrolysis is achieved by passing the salt water solution through an electrolytic cell which converts sodium chloride (salt) into the water into chlorine gas which, when dissolved in water become sodium hypochlorite (liquid chlorine)

### SAFE AND RESPECTING THE ENVIRONMENT, THIS TECHNOLOGY BRINGS YOU

- Relaxation : Your pool is automatically disinfected
- Safety : Reduction in chlorine storage and handling
- Comfort : Clean, safe and crystal-clear water
- Health and well-being : therapeutic, salt water does not irritate eyes and dry out skin

### HIGHLIGHT FEATURES

- Self cleaning reverse polarity
- Quality Titanium cells
- Light Transformer models
- Cell life time 5000 – 8000 hours
- Maximum working pressure: 250kPa / 36psi / 2.5 bar



## Technical Information

Model	Description	Salt Level (ppm)	Cell Output (gram/h)	Fiberglass Pool (L)	Concrete Pool (L)	Pool Light Voltage	Input Voltage /Freq	IP Rating	Weight (kg)
SSC15-E	Standard Version	4000	15	50,000	45,000	N/A	240V 50/60Hz	IPX4	6.5
SSC25-E			25	75,000	70,000				7.4
SSC50-E			45	120,000	110,000				9.7
SSC15-T	With Time Clock	4000	15	50,000	45,000	N/A	240V 50/60Hz	IPX4	6.6
SSC25-T			25	75,000	70,000				7.5
SSC50-T			45	120,000	110,000				9.8

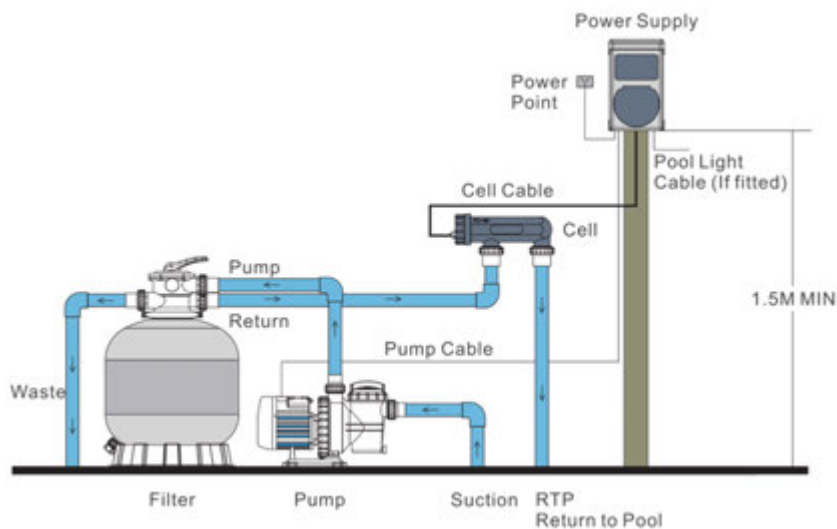

Standard Range of Salt Level in the Pool : 3500 – 4000 ppm

Commissioning Pool : Salt quantity is 3.5 - 4 Kg/m<sup>3</sup>

Maintenance Pool to maintain CL level at 1.5-2 ppm: Salt quantity is 3.5 – 4 Kg/m<sup>3</sup>

Code	Model	Type	Gram/Hour	Max. Pool Volume (m <sup>3</sup> )		Power Consumption (Watts)	Retail Price	Code✕
				Turnover Time 6 hr/day	Turnover Time 8 hr/day			
20900510080	SSC15-E	Standard Version (No Timer)	15	45	55	140	46,000.00	H★
20900510085	SSC25-E		25	75	95	240	57,500.00	
20900510090	SSC50-E		45	120	160	480	63,000.00	
20900510005	SSC15-T	With Timer Clock	15	45	55	140	51,800.00	
20900510010	SSC25-T		25	75	95	240	60,500.00	
20900510015	SSC50-T		45	120	160	480	66,900.00	

หมายเหตุ : ราคายังไม่รวมภาษี 7% บริษัทฯ ขอสงวนสิทธิ์ในการเปลี่ยนแปลงราคาโดยไม่ต้องแจ้งให้ทราบล่วงหน้า  
 Remarks : Excluded VAT 7%. The Company reserves the right to change the prices without announcement.



# “EMAUX” SSC-One Series Salt Chlorinators With Automatic pH Feeder

## ONE-TOUCH MULTI-FUNCTIONAL CHLORINATOR

For residential and semi-commercial pools Salt chlorinated pools are among the best to enjoy a comfortable bath, but such systems tend to raise pH. With SSCone you get the right solution: its automatic dosing pump injects acid to achieve the proper pH balance, obtaining the most efficient chlorine generated by the Emaux cell. No harmful by-products. It is programmed automatically.



### HIGHLIGHT FEATURES

- Timer for pump and cell programmable control.
- Direct power function
- Boost button, sets the system in super chlorination, 100% power for 24 hours.
- Visual pH reading, and easy set-up.
- Capacitive touch buttons control panel.
- Switch reverse polarity to the needed time depending on water hardness to minimize cell scaling. Every 4 or 8 or 12 hours.
- Fully automatic or manual.
- Winter mode reduce power to 30%



### Product Dimensions and Technical Information

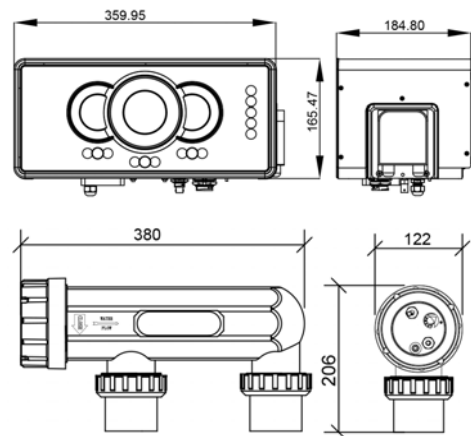

### ACCESSORIES



Model	Input Voltage/ Frequency	Salt Level	Cell Output	Maximum Pool Size	Cell Connections
SSCone	110-230V / 50-60Hz	2500ppm	Up to 50gr/hr	Up to 150,000 Liters	1.5" / 50mm or 2" / 63mm

Standard Range of Salt Level in the Pool : 2500 ppm

Commissioning Pool : Salt quantity is 2.5 Kg/m<sup>3</sup>

Maintenance Pool to maintain CL level at 1.5-2 ppm: Salt quantity is 2.5 Kg/m<sup>3</sup>

Code	Model	Water Capacity (m <sup>3</sup> )	Gram/Hour	Power Consumption (Watts)	Retail Price	Code✳
20900510115	SSC-One	150	Up to 50	260	110,000.00	H

หมายเหตุ : ราคายังไม่รวมภาษี 7% บริษัทฯ ขอสงวนสิทธิ์ในการเปลี่ยนแปลงราคาโดยไม่ต้องแจ้งให้ทราบล่วงหน้า  
Remarks : Excluded VAT 7%. The Company reserves the right to change the prices without announcement.



# “BSV” BS Series Residential Salt Chlorinators Made In Spain

COMPACT SALT WATER CHLORINATOR IN IP65 BOX WITH DIGITAL DISPLAY AND PRODUCTION FROM 10 TO 35 GRAMS FOR PRIVATE POOLS

- ✓ Lower electrical consumption
- ✓ Lower weight
- ✓ IP65 Waterproof Index
- ✓ Lower operating temperature.
- ✓ More compact, easily adaptable to any installation.
- ✓ Switch mode power supply improves importantly the unit performance.
- ✓ Longer durability of the electrolysis cell.
- ✓ Internal microprocessor control that determines the device operating hours



5K 5.000Hours    Low weightt    IP65 Box    Low Consumption

	N-Bssalt-10	N-Bssalt-15	N-Bssalt-20	N-Bssalt-25	N-Bssalt- 35
Tensión de alimentación Power Supply	230Vac – 50/60Hz				
Corriente máxima de la célula Max cell current	10A	15A	20A	25A	35A
Producción gr/hora Gr/hour production	10gr/h	15gr/h	20gr/h	25gr/h	35gr/h
Potencia máxima Max Power	75W	112,5W	150W	187,5W	263W
Tensión máxima de la célula Max cell voltage	7,5Vcc				
Sal necesaria* Salt required*	4gr/l				

Start up salt quantity is 5kg per 1 m<sup>3</sup> volume of water

Code	Model	Gram/Hour	Recommended Pool Volume (m <sup>3</sup> ) at Turnover 8 Hours/Day	In & Outlet (Inches)	Retail Price	Code✘
20900210120	N-Bsalt-10	10	25	2	46,200.00	H ★
20900210125	N-Bsalt-15	15	50	2	50,400.00	
20900210130	N-Bsalt-20	20	75	2	60,900.00	
20900210135	N-Bsalt-25	25	100	2	64,800.00	
20900210140	N-Bsalt-35	35	125	2	74,200.00	

หมายเหตุ : ราคายังไม่รวมภาษี 7% บริษัทฯ ขอสงวนสิทธิ์ในการเปลี่ยนแปลงราคาโดยไม่ต้องแจ้งให้ทราบล่วงหน้า  
Remarks : Excluded VAT 7%. The Company reserves the right to change the prices without announcement.



# “BSV” Pro 50 - 150 Series Commercial Salt Chlorinators Made In Spain

**SALT WATER CHLORINATOR WITH PRODUCTIONS FROM 50 TO 150 GRAMS PER HOUR. FOR BIG DOMESTIC POOLS AND SMALL PROFESSIONAL POOLS.**

- ✓ Lower electrical consumption
- ✓ Lower weight
- ✓ Suitable in hot and humid environments.
- ✓ Lower operating temperature.
- ✓ More compact, easily adaptable to any installation.
- ✓ Switch mode power supply improves importantly the unit performance.
- ✓ Longer durability of the electrolysis cell.
- ✓ Kit flow switch already included
- ✓ Upgraded at any time by adding the optional kits.
- ✓ Digital Display, easy and intuitive control
- ✓ Cell Life Time 10,000 Hours



Cell For  
50 / 70



Cell For  
100 / 150

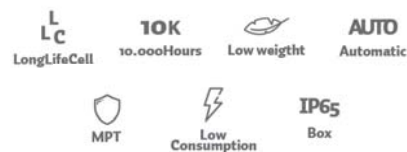

- When the water in the pool exceeds a temperature of 28°C regularly, select the production immediately higher than indicated by the table.
- The number of bathers per day is very important value in Semi-Public Swimming pools. If this parameter is bigger than above, the Salt Chlorinator system needs to be calculated again.

grams / hour =	$2 \text{ ppm} \times \text{Volume of Pool (m}^3\text{)}$ $+ (14 \times \text{Bading load per day})$
กรัม / ชั่วโมง =	$2 \text{ ppm} \times \text{ปริมาณน้ำในสระ (m}^3\text{)}$ $+ (14 \times \text{จำนวนคนลงสระต่อวัน})$ จำนวนชั่วโมงของระบบกรอง/วัน

**Start up salt quantity is 5kgs per 1 m<sup>3</sup> volume of water**

Code	Model	Gram/Hour	Recommended Pool Volume (m <sup>3</sup> ) at Turnover 8 Hours/Day	In & Outlet (Inches)	Retail Price	Code✳
20900210055	Pro-50 ✳	50	Up to 175 m <sup>3</sup>	2.5	169,000.00	B
20900210060	Pro-70 ✳	70	Up to 225 m <sup>3</sup>	2.5	199,000.00	
20900210065	Pro-100 ✳	100	Up to 300 m <sup>3</sup>	3	249,000.00	
20900210070	Pro-150 ✳	150	Up to 375 m <sup>3</sup>	3	319,000.00	

✳ สินค้าไม่มีสต็อก กรุณาสั่งล่วงหน้า 30-60 วัน / No Stock, Delivery Time 30-60 Days

หมายเหตุ : ราคายังไม่รวมภาษี 7% บริษัทฯ ขอสงวนสิทธิ์ในการเปลี่ยนแปลงราคาโดยไม่ต้องแจ้งให้ทราบล่วงหน้า  
 Remarks : Excluded VAT 7%. The Company reserves the right to change the prices without announcement.



# “BSV” Pro 200 Series Commercial Salt Chlorinator Made In Spain

SALT WATER CHLORINATOR WITH PRODUCTIONS 200 GRAMS PER HOUR FOR MEDIUM SIZE POOLS WITH AN IMPORTANT CHARGE OF USERS.



- ✓ Lower electrical consumption
- ✓ IP-21 Index Protection
- ✓ Lower operating temperature.
- ✓ Internal microprocessor control, that determines the device operating hours
- ✓ Longer durability of the electrolysis cell.
- ✓ Digital display, easy and intuitive control



- When the water in the pool exceeds a temperature of 28°C regularly, select the production immediately higher than indicated by the table.
- The number of bathers per day is very important value in Semi-Public Swimming pools. If this parameter is bigger than above, the Salt Chlorinator system needs to be calculated again.

grams / hour =	2 ppm x Volume of Pool (m <sup>3</sup> ) + (14 x Bading load per day)
	Filtration Turnover / day (hour)
กรัม / ชั่วโมง =	2 ppm x ปริมาณน้ำในสระ (ม <sup>3</sup> ) + (14 x จำนวนคนลงสระต่อวัน)
	จำนวนชั่วโมงของระบบกรองต่อวัน

Start up salt quantity is 5kgs per 1 m<sup>3</sup> volume of water

Code	Model	Gram/Hour	Recommended Pool Volume (m <sup>3</sup> ) at Turnover 8 Hours / Day	Number of Bathers / Day	In & Outlet (Inches)	Retail Price	Code✳
20900210075	Pro-200-V2 ✳	200	Up to 450 m <sup>3</sup>	50	3	479,000.00	B

หมายเหตุ : ราคายังไม่รวมภาษี 7% บริษัทฯ ขอสงวนสิทธิ์ในการเปลี่ยนแปลงราคาโดยไม่ต้องแจ้งให้ทราบล่วงหน้า  
Remarks : Excluded VAT 7%. The Company reserves the right to change the prices without announcement.





# “BSV” Pro 250 - 1000 Series Commercial Salt Chlorinators Made In Spain

**MODULAR SALT WATER CHLORINATOR.  
PRODUCTIONS FROM 250 TO 1000 GRAMS /  
HOUR. USEFUL ON COMMERCIAL AND  
PROFESSIONAL POOLS.**

- ✓ Lower electrical consumption
- ✓ (IP21) Index protection
- ✓ Lower operating temperature
- ✓ Better output of the salt water chlorination by using a last generation switch mode power supply
- ✓ Longer durability of the electrolysis cell
- ✓ Internal microprocessor control, that determines the device operating hours
- ✓ Digital display, easy and intuitive use control

- When the water in the pool exceeds a temperature of 28°C regularly, select the production immediately higher than indicated by the table.
- The number of bathers per day is very important value in Semi-Public Swimming pools. If this parameter is bigger than above, the Salt Chlorinator system needs to be calculated again.



**12K** **AUTO** **Low Consumption**  
 LongLifeCell 12.000 Hours Low weight Automatic MPT Low Consumption

grams / hour =	2 ppm x Volume of Pool (m <sup>3</sup> ) + (14 x Bading load per day) Filtration Turnover / day (hour)
กรัม / ชั่วโมง =	2 ppm x ปริมาณน้ำในสระ (ม <sup>3</sup> ) + (14 x จำนวนคนลงสระต่อวัน) จำนวนชั่วโมงของระบบกรองต่อวัน

**Start up salt quantity is 5kgs per 1 m<sup>3</sup> volume of water**

Code	Model	Gram/Hour	In & Outlet (Inches)	Retail Price	Code✳
20900210080	Pro-250-V2 ✳	250	3	649,000.00	B
20900210085	Pro-500 ✳	500	3	กรุณาติดต่อเจ้าหน้าที่ / Please Check with Sales Assistance	
20900210090	Pro-750 ✳	750	3		
20900210095	Pro-1000 ✳	1000	3		

✳ สินค้าไม่มีสต็อก กรุณาสั่งล่วงหน้า 30-60 วัน / No Stock, Delivery Time 30-60 Days

หมายเหตุ : ราคายังไม่รวมภาษี 7% บริษัทฯ ขอสงวนสิทธิ์ในการเปลี่ยนแปลงราคาโดยไม่ต้องแจ้งให้ทราบล่วงหน้า  
 Remarks : Excluded VAT 7%. The Company reserves the right to change the prices without announcement.



## “BSV” Accessories For Pro Series

Code	Model	Description	Retail Price	Code✘
20910210010	Kit Advanced✘	Kit ORP (Redox sensor + Installation Accessories)		กรุณาติดต่อเจ้าหน้าที่ / Please Check with Sales Assistance



Code	Model	Description	Suitable	Retail Price	Code✘
20910210015	Kit Auto✘	Kit Domestic Pool pH Sensor (pH Sensor + Peristaltic Dosing Pump of 1.5 L/h + Installation Accessories)	Domestic Pool		กรุณาติดต่อเจ้าหน้าที่ / Please Check with Sales Assistance
20910210135	Kit Auto PRO✘	Kit Public Pool pH Sensor (pH Sensor + Peristaltic Dosing Pump of 4 L/h + Installation Accessories)	Public Pool		



Code	Model	Description	Retail Price	Code✘
20910210030	Kit PRO CL✘	Kit Free Chlorine (PPM)		กรุณาติดต่อเจ้าหน้าที่ / Please Check with Sales Assistance



Code	Model	Description	Retail Price	Code✘
20910210035	Kit Sondaagua✘	Kit External Flow Sensor		กรุณาติดต่อเจ้าหน้าที่ / Please Check with Sales Assistance



Code	Model	Description	Retail Price	Code✘
20910210040	Kit Sondaagua Pro✘	Kit External Flow Sensor Pro		กรุณาติดต่อเจ้าหน้าที่ / Please Check with Sales Assistance



Code	Model	Description	Retail Price	Code✘
20900210100	Kit NTC/1✘	Kit Temperature		กรุณาติดต่อเจ้าหน้าที่ / Please Check with Sales Assistance



Code	Model	Description	Retail Price	Code✘
20910210045	Kit Tierra/1✘	Kit Earth Connection		กรุณาติดต่อเจ้าหน้าที่ / Please Check with Sales Assistance



Code	Model	Description	Retail Price	Code✘
20900210115	Kit PRO pHRX✘	Kit PH - Redox Pro Panel (Panel Inc. The Redox & pH Sensors, With An Acrylic Probe Holder And Cartridge Filter, Inc. A Magnetic Dosing Pump of 5L/h And 7.5 Bars For pH Dosing)		กรุณาติดต่อเจ้าหน้าที่ / Please Check with Sales Assistance



Code	Model	Description	Retail Price	Code✘
20900210110	Kit PRO pHCL✘	Kit Free Chlorine Pro Panel (Panel Inc. The Free Chlorine & pH Sensors, With An Acrylic Probe Holder And Cartridge Filter, Inc. A Magnetic Dosing Pump of 5L/h And 7.5 Bars For pH Dosing)		กรุณาติดต่อเจ้าหน้าที่ / Please Check with Sales Assistance



✘ สินค้าไม่มีสต็อก กรุณาสั่งล่วงหน้า 30-60 วัน / No Stock, Delivery Time 30-60 Days

หมายเหตุ : ราคายังไม่รวมภาษี 7% บริษัทฯ ขอสงวนสิทธิ์ในการเปลี่ยนแปลงราคาโดยไม่ต้องแจ้งให้ทราบล่วงหน้า  
Remarks : Excluded VAT 7%. The Company reserves the right to change the prices without announcement.



# “EMAUX” MPUV Series Nano Tech UV-C Systems

## LOW COST HIGH UV EFFICIENCY

For commercial water disinfection and chloramine reduction

No Harmful Chemical, A Non-Toxic Alternative The NT-MPUV series of medium pressure ultraviolet units is designed to be an easy to install system giving a cost effective solution for commercial disinfection and chloramine reduction.

Medium pressure UV systems are very effective against highly infectious *Cryptosporidium parvum* and *Giardia lamblia* species which can exist in swimming pool water. These are virtually unaffected by the levels of chlorine used to sanitize swimming pools. The use of chlorine in swimming pools results in the formation of chloramines as a direct result of its interaction with pollutants and it is these that result in eye and skin irritation combined with unpleasant odors.



## ADVANTAGE

- Substantial reduction in chloramines
- Medium pressure UV lamps for maximum oxidation
- Microprocessor control with data logging
- Connects to building management systems
- Automatic "Smartdrive" wiper system as standard
- Simple lamp replacement
- CE approved
- 316 L Stainless steel reactor vessel

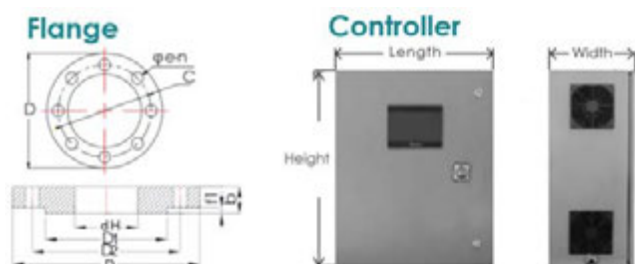

HG-20592 PN 1.0 Mpa Standard flange size

DN	Model	D (mm)	D2 (mm)	ipe-n	Bolt Specification	D1 (mm)	dH (mm)	f1 (mm)	b (mm)
DN80	3"	200	160	18-8	M16	132	90.5	2	20
DN100	4"	220	180	19-8	M16	156	116	2	22
DN150	6"	285	240	22-8	M20	211	170.5	2	24
DN200	8"	340	295	22-8	M20	266	221.5	2	24
DN250	10"	395	350	22-12	M20	319	276.5	2	26

## MAIN CHARACTERISTICS

- Easy to install with in-line vessel design
- Higher UV efficiency
- Typical UVT is 90% at 60 mJ/cm<sup>2</sup>
- Input power cost
- Lower power consumption

Reactor

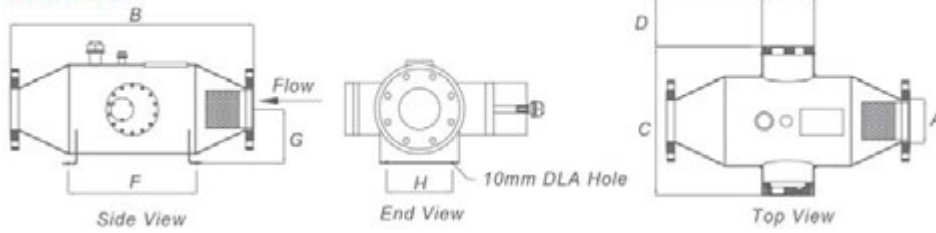

Controller



Reactor

Technical Information and Dimensions:

Model	Connection	Flow Rate		Lamp Power (kW)	Supply Rating (V/psi/Hz)	Control Panel Dimension mm (LxWxH)	Reactor Dimensions (mm/inch)						
		m <sup>3</sup> /h	US gpm				A	B	C	D	F	G	H
NT-MPUV40	DN80	40	175	1.0	200-240/1/50-60 360-380/3/50-60	600x300x600	80/3.0	740/29.1	422/16.6	195/7.7	300/11.8	2007.9	170/6.7
NT-MPUV60	DN100	60	264	1.5	200-240/1/50-60 360-380/3/50-60	600x300x700	100/4.0	740/29.1	422/16.6	195/7.7	300/11.8	2007.9	170/6.7
NT-MPUV105	DN150	105	460	2.0	200-240/1/50-60 360-380/3/50-60	600x300x700	150/6.0	800/31.5	422/16.6	195/7.7	400/15.7	2007.9	170/6.7
NT-MPUV145	DN150	145	640	2.5	200-240/1/50-60 360-380/3/50-60	600x300x700	150/6.0	820/32.3	585/23	195/7.7	400/15.7	275/10.8	250/9.8
NT-MPUV170	DN150	170	750	3.0	200-240/1/50-60 360-380/3/50-60	600x300x700	150/6.0	820/32.3	585/23	195/7.7	400/15.7	275/10.8	250/9.8
NT-MPUV220	DN200	220	970	2x2.0=4.0	200-240/1/50-60 360-380/3/50-60	700x300x1100	200/8.0	890/35.0	422/16.6	195/7.7	450/17.7	225/8.8	250/9.8
NT-MPUV300	DN200	300	1320	2x2.5=5.0	200-240/1/50-60 360-380/3/50-60	700x300x1100	200/8.0	890/35.0	585/23	195/7.7	450/17.7	275/10.8	330/13
NT-MPUV355	DN250	355	1560	2x3.0=6.0	200-240/1/50-60 360-380/3/50-60	700x300x1100	250/10.0	890/35.0	585/23	195/7.7	450/17.7	275/10.8	330/13
NT-MPUV415	DN250	415	1825	2x3.5=7.0	200-240/1/50-60 360-380/3/50-60	700x300x1100	250/10.0	890/35.0	585/23	195/7.7	450/17.7	275/10.8	330/13

MP vs LP UV Lamp Comparison:

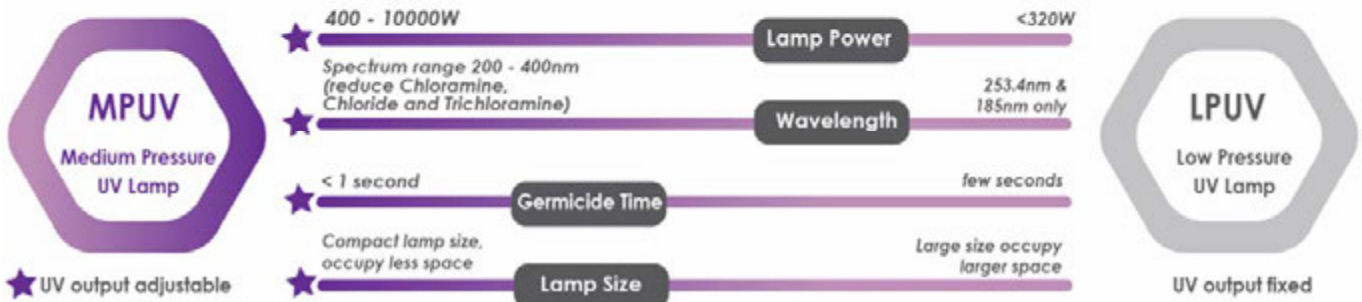

Code	Model	Flowrate (m <sup>3</sup> /h)	Input Power (W)	Connection (Inches)	Retail Price	Code✖
20310510215	NT-MPUV40✖	40	1000	3	กรุณาติดต่อเจ้าหน้าที่ / Please Check with Sales Assistance	
20310510220	NT-MPUV60✖	60	1500	4		
20310510225	NT-MPUV105✖	105	2000	6		
20310510230	NT-MPUV145✖	145	2500	6		
20310510235	NT-MPUV170✖	170	3000	6		
20310510240	NT-MPUV220✖	220	4000	8		
20310510245	NT-MPUV300✖	300	5000	8		
20310510250	NT-MPUV355✖	355	6000	10		
20310510255	NT-MPUV415✖	415	7000	10		

✖ สินค้าไม่มีสต็อก กรุณาสั่งล่วงหน้า 60-90 วัน / No Stock, Delivery Time 60-90 Days

หมายเหตุ : ราคายังไม่รวมภาษี 7% บริษัทฯ ขอสงวนสิทธิ์ในการเปลี่ยนแปลงราคาโดยไม่ต้องแจ้งให้ทราบล่วงหน้า  
Remarks : Excluded VAT 7%. The Company reserves the right to change the prices without announcement.



# “EMAUX” NT-UV-T Series Nano Tech UV-C Systems With Timer

### NANOTECH UV-C TIMER

Emaux Nano-Tech UVC Timer includes an integrated TIMER which is accurately monitors the operating hours of the UV-C lamp. You will be reminded when the lamp must be replaces

### ADVANTAGE OF COMPRISING A TIMER

- User-friendly control pad with time clock and time meter display
- Integrated adjustable time meter for the UV-C lamp
- Digital indication when the lamp needs replacing



Note : "T" stands for Timer

Model	Max Flow Rate (m <sup>3</sup> /h)	Pool Vol (m <sup>3</sup> )	Input Power	Maximum Pressure	Connections	Electric Ballast	Maximum Current (A)	UV Lamp lifetime (hr.)
NT-UV40-T	20	40	40W	3 bar	1.5"/50mm or 2"/63mm	120-240V AC	0.44(120V) 0.2(240V)	9,000
NT-UV75-T	25	75	75W	3 bar	1.5"/50mm or 2"/63mm	120-240V AC	0.82(120V) 0.38(240V)	9,000

Code	Model	Flowrate (m <sup>3</sup> /h)	Volume of Water (m <sup>3</sup> )	Input Power (W)	Connection (Inches)	Retail Price	Code✳
21000510025	NT-UV40-T	20	40	40	2"	23,900.00	H★
21000510030	NT-UV75-T	25	75	75	2"	26,900.00	

หมายเหตุ : ราคายังไม่รวมภาษี 7% บริษัทฯ ขอสงวนสิทธิ์ในการเปลี่ยนแปลงราคาโดยไม่ต้องแจ้งให้ทราบล่วงหน้า  
Remarks : Excluded VAT 7%. The Company reserves the right to change the prices without announcement.



# “EMAUX” NT-UV130-TF Series Nano Tech UV-C Systems With Amalgam Lamps & Flow Switch Version

The amalgam lamps set between the low pressure and medium pressure UV applications, by combining high efficiencies with relative high power densities operating in a broad temperature range.

The amalgam includes a flow switch which will cut-off the lamp power to protect the system from over-heating when the water flow is lower than required version.

By applying a special coating technology, we are able to guarantee a maintenance to 85% after 9,000 hours operating in a broad temperature range.

Optional Timer version is included

### MAIN APPLICATIONS

- Drinking water treatment systems
- Waste water treatment systems
- Process water treatment units
- Swimming pool treatment systems



Note : "F" stands for Flowswitch, "T" stands for Timer

Model	Max Flow Rate (m <sup>3</sup> /h)	Pool Vol (m <sup>3</sup> )	Input Power	Maximum Pressure	Connections	Electric Ballast	Maximum Current (A)	UV Lamp lifetime (hr.)
NT-UV130TF	30	130	130W	3 bar	1.5"/50mm or 2"/63mm	240V AC	0.95	12,000

Code	Model	Flowrate (m <sup>3</sup> /h)	Volume of Water (m <sup>3</sup> )	Input Power (W)	Connection (Inches)	Retail Price	Code✳
21000510035	NT-UV130-TF	30	130	130	2"	47,900.00	H★

หมายเหตุ : ราคายังไม่รวมภาษี 7% บริษัทฯ ขอสงวนสิทธิ์ในการเปลี่ยนแปลงราคาโดยไม่ต้องแจ้งให้ทราบล่วงหน้า  
Remarks : Excluded VAT 7%. The Company reserves the right to change the prices without announcement.



# “EMAUX” NT-UV87-TO Series Nano Tech UV-C Systems With Ozone Version

## Nano Tech UV-C Ozone

Emaux Nano Tech UV-C Ozone combines the ozone and UV-C technology which ensure fresh and healthy pool water with the minimum use of chlorine



## ADVANTAGE OF THE NANO TECH UV-C OZONE

- Built-in electronics pre-selector to ensure a smooth power supply
- Up to 35% more UV-C yield as a result of reflection
- Reduces the chlorine consumption up to 95%
- Ozone UV-C lamp last for 9,000 hours
- Integrated adjustable time meter for the UV-C lamp
- Digital indication with the lamp needs replacing

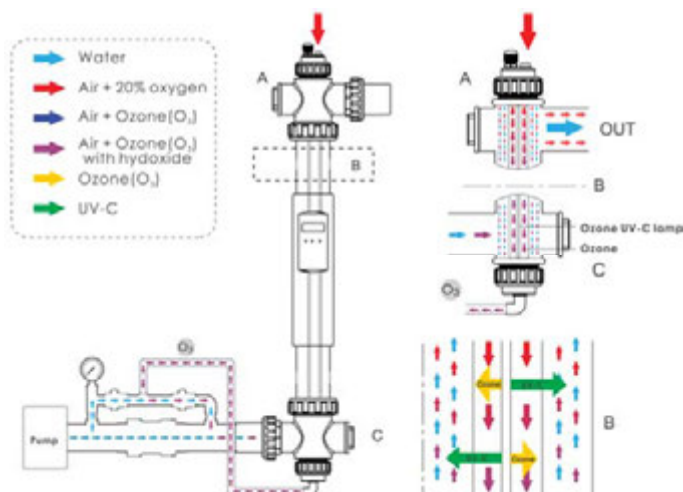

## UV-C OZONE OPERATION

The water is pumped into the unit through the reactor. Air is sucked through the venture system into the unit via the air injector and flows through the quartz glass and the ozone UV-C lamp. The air enters the lamp and loaded with ozone particles, the pass the ball valve and the mixed with the water in the reactor

for Ozone, "T" stands for Timer

Model	Max Flow Rate (m <sup>3</sup> /h)	Pool Vol (m <sup>3</sup> )	Input Power	Maximum Pressure	Cell Connections	Electric Ballast	Max Current (A)	UV Lamp lifetime (hr.)
NT-UV87-TO	25	90	87W	3 bar	1.5"/50mm or 2"/63mm	240V AC 50-60Hz	0.5	9000

Code	Model	Flowrate (m <sup>3</sup> /h)	Volume of Water (m <sup>3</sup> )	Input Power (W)	Connection (Inches)	Retail Price	Code✳
21000510040	NT-UV87-TO	25	90	87	2"	38,900.00	H★

หมายเหตุ : ราคายังไม่รวมภาษี 7% บริษัทฯ ขอสงวนสิทธิ์ในการเปลี่ยนแปลงราคาโดยไม่ต้องแจ้งให้ทราบล่วงหน้า  
Remarks : Excluded VAT 7%. The Company reserves the right to change the prices without announcement.



# “EMAUX” FOS Series UV-C Systems For Fish Pon

Achieve up to 98% Sterilization rate  
Specialized for fish ponds and aquaculture

### CONTROL FISH POND INFECTION AND DISEASES

FOS series UV-C disinfection system is an effective product to kill bacteria and other microbes that pass through from the tube as a result to maintain bacteria-free and purified water in your fish pond

- High quality UV-C lamp that achieve 98% Sterilization Rate
- Durable UV-C lamp has Long Life Span, more than 10,000 hours.
- High quality Quarts tube provides more than 99% Transmittance Rate
- Adjustable brackets for simpler and flexible installation
- Suitable for fish pond sized up to 14m<sup>3</sup>
- UV for fish pond – UV lamp 5W / 1 m<sup>3</sup> of water

### TYPICAL INSTALLATION

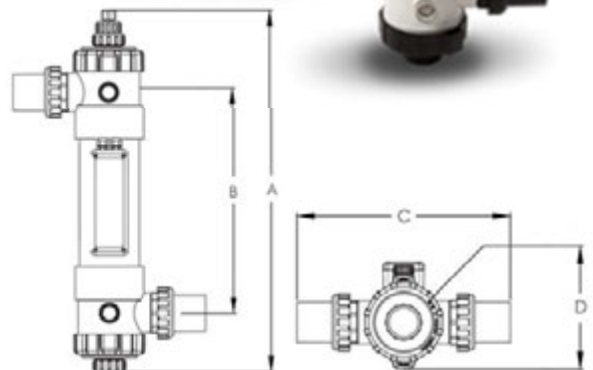
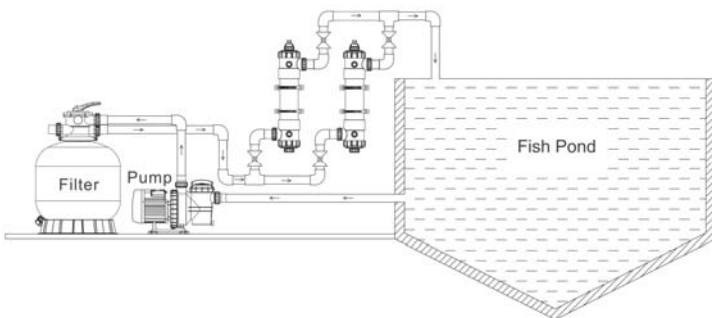

### Product Dimensions

Model	A (mm)	B (mm)	C (mm)	D (mm)
FOS-UV-5T	694	431	180	166
FOS-UV-7T	694	431	180	166
FOS-UV-8T	1144	881	180	166
FOS-UV-14T	1144	881	180	166

Code	Model	Flowrate (m <sup>3</sup> /h)	Volume of Water (m <sup>3</sup> )	Input Power (W)	Connection (Inches)	Retail Price	Code✳
21000510005	FOS-UV-5T	14.4	5	15	1.5" / 2"	12,000.00	H★
21000510010	FOS-UV-7T	14.4	7	25	1.5" / 2"	13,900.00	
21000510015	FOS-UV-8T	14.4	8	30	1.5" / 2"	16,500.00	
21000510020	FOS-UV-14T	14.4	14	55	1.5" / 2"	17,900.00	

หมายเหตุ : ราคายังไม่รวมภาษี 7% บริษัทฯ ขอสงวนสิทธิ์ในการเปลี่ยนแปลงราคาโดยไม่ต้องแจ้งให้ทราบล่วงหน้า  
Remarks : Excluded VAT 7%. The Company reserves the right to change the prices without announcement.





# “EMAUX” CL Series Chlorine Feeders

## HIGH CAPACITY CHEMICAL FEEDERS

Emaux high capacity feeders offer user-friendly solution for sanitizing large residential and commercial swimming pool using either chlorine and bromine tablets. They are heavy duty and able to provide automatic sanitization for pools up to 608000 liters. Both in-line and off-line plumbing installations are available in 2 sizes.

## PRODUCT FEATURES

1. Provide a very economical, user-friendly solution for sanitizing large residential and commercial swimming pools using either chlorine or bromine tablets.
2. Heavy duty, different models to provide automatic sanitization for pools up to 608,000 litres.
3. In-line and off-line plumbing installations are available in 2 sizes.



**MODEL: CL-01 & CL-02 (In-line)**

MODEL: CL-01 (In-line)  
 10 ppm ----- 25000L pool  
 5 ppm ----- 50000L pool  
 2.5ppm ----- 100000L pool

MODEL: CL-02 (In-line)  
 10 ppm ----- 27000L pool  
 5 ppm ----- 54000L pool  
 2.5ppm ----- 108000L pool



**MODEL: CL-01A & CL-02A (Off-line)**

MODEL: CL-01 A (Off-line)  
 10 ppm ----- 45000L pool  
 5 ppm ----- 90000L pool  
 2.5ppm ----- 180000L pool

MODEL: CL-02A (Off-line)  
 10 ppm ----- 49000L pool  
 5 ppm ----- 98000L pool  
 2.5ppm ----- 196000L pool



**MODEL: CLL-50 & CLL-75**

MODEL: CLL-50 (In-line)  
 10 ppm ----- 95000L pool  
 5 ppm ----- 190000L pool  
 2.5ppm ----- 380000L pool

MODEL: CLL-75 (In-line)  
 10 ppm ----- 152000L pool  
 5 ppm ----- 304000L pool  
 2.5ppm ----- 608000L pool



Technical Information

Model	Chlorine Tablet Specification	Quantity (pc)	Total Weight (kg)	Valve Connection	A (mm)	B (mm)	C (mm)
CL-01	Ø30x16mm/pc	102	2	1.5" 50mm	420	330	110
	Ø76x26mm/pc	11					
CL-02	Ø30x16mm/pc	198	4	1.5" 50mm	705	330	110
	Ø76x26mm/pc	22					
CL-01A	Ø30x16mm/pc	102	2	- 10mm	420	230	110
	Ø76x26mm/pc	11					
CL-02A	Ø30x16mm/pc	198	4	- 10mm	705	230	110
	Ø76x26mm/pc	22					
CLL-50	Ø30x16mm/pc	300	6	1.5" 50mm	580	440	225
	Ø76x26mm/pc	32					
CLL-75	Ø30x16mm/pc	550	11	1.5" 50mm	780	440	225
	Ø76x26mm/pc	50					

This feeder can ONLY be used with slow-dissolving Tri-Chlor. Do NOT mix with other type of chlorine or chemical, otherwise, it may cause an explosion or fire.

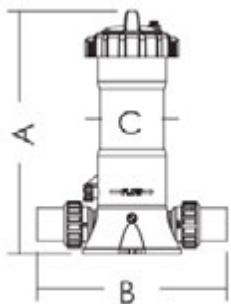
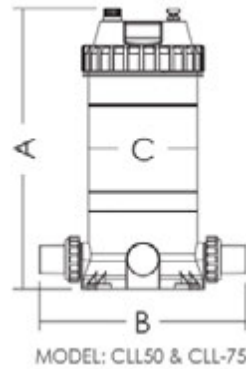

MODEL: CL-01 & CL-02 (In-line)

1.Model: CL-01/CL-02/CLL-50/CLL-75 (In-line)

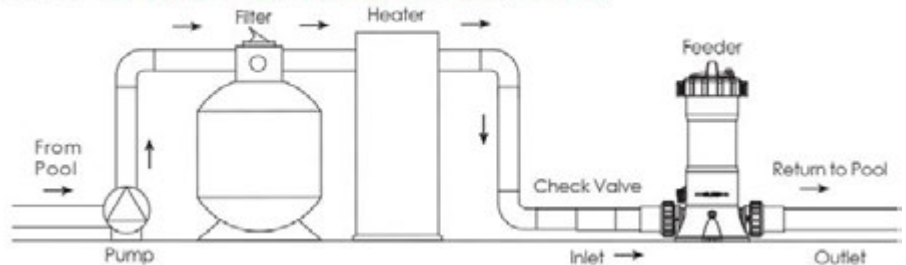

Code	Model	Chlorine (kgs)	Type	Retail Price	Code✖
21030510005	CL-01	2	In-line	3,800.00	H★
21030510015	CL-02	4	In-line	5,100.00	
21030510025	CLL-50	6	In-line	11,400.00	
21030510030	CLL-75	11	In-line	14,000.00	

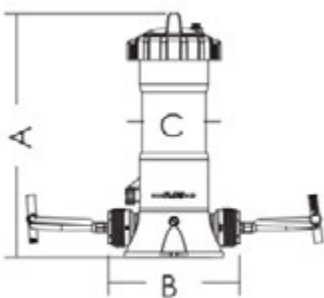

MODEL: CL-01A & CL-02A (Off-line)

2.Model: CL-01A/CL-02A (Off-line)

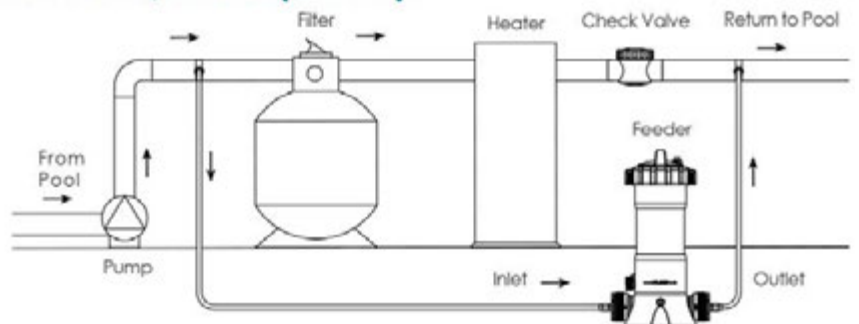

Code	Model	Chlorine (kgs)	Type	Retail Price	Code✖
21030510010	CL-01A	2	Off-line	5,100.00	H★
21030510020	CL-02A	4	Off-line	6,400.00	

หมายเหตุ : ราคายังไม่รวมภาษี 7% บริษัทฯ ขอสงวนสิทธิ์ในการเปลี่ยนแปลงราคาโดยไม่ต้องแจ้งให้ทราบล่วงหน้า  
 Remarks : Excluded VAT 7%. The Company reserves the right to change the prices without announcement.



# “EMAUX” CTRL Series Solenoid Driven Metering Pumps Complete Set With Accessories

## HIGH-TECH MICROCONTROLLER

The automatic monitoring system measures the PH value and Redox / ORP value of water through the relative voltage of probes. Total control & dosing through the desired set-point. With a compact structure, nice design, professional recognition, easy to install and operate. Digital metering pump with pH/Redox control meter on board. Adjustable manual control with proportional dosing flow rate, for the right pH & Redox management.

## MAIN FEATURES

- Significant number of metering pumps, 16 work dual-line LCD Screen, full working status display automatic recording and storage.
- Built-in pH / ORP monitor or dosing only
- Automatic pump flow control is determined in accordance with monitor pH / ORP value.
- pH, ORP, flow and other automatic / manual calibration.
- With level gauge input interface, low level alarm.
- Flow meter input, telematics control.
- Password Protection



Model	Pressure (bar)	Max Flow/ Hour (l/h)	Stroke capacity (cc/stroke)	Connection Size in/out (mm)	Frequency max (stroke/min)
CTRL4-PH	12	4	0.42	4 / 6	160
	10	5	0.52	4 / 6	160
CTRL4-ORP	8	6	0.63	4 / 6	160
	2	8	0.83	4 / 6	160
CTRL7-PH	12	7	0.36	4 / 6	320
	10	10	0.52	4 / 6	320
CTRL7-ORP	5	15	0.78	4 / 6	320
	1	18	0.99	4 / 6	320
CTRL20-PH	5	20	1.11	8 / 12	300
	4	25	1.39	8 / 12	300
CTRL20-ORP	2	38	2.11	8 / 12	300
	0.1	54	3	8 / 12	300

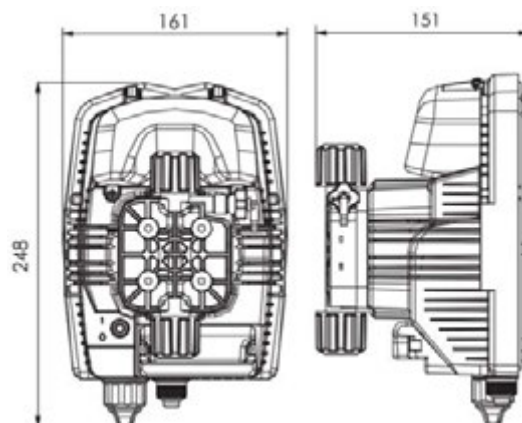



Probe and Accessories Specifications

Code	Product Name	Parameter	Photo
87990300	pH probe	Pressures 7bar Material: epoxy resin Measuring range: 0-14 (With 6m signal line) Electrode diameter: 12mm (Includes probe holder)	
87990301	ORP probe	Pressure: 7bar Material: epoxy resin Measuring range: 1200mV (With 6m signal line) Electrode diameter: ± 12mm (Includes probe holder)	
87990302	pH probe buffer solution	2 bottles of buffer solution of pH (pH4.00 and pH7.00) +1 bottle for buffering	
87990303	ORP probe buffer solution	1 bottle of ORP buffer solution (465mV) for 50ml bottle	
87990306	Dosing pipe fittings for CTRL4/ 7	Pressure: 7bar Material: PVC Screw size: 1/2"	
87990304	Dosing pipe fittings for CTRL20	The maximum resistance at: 60°C	
87990305	Fixing Accessories	Vertical base and wall-mounting accessories	

Installation Diagram

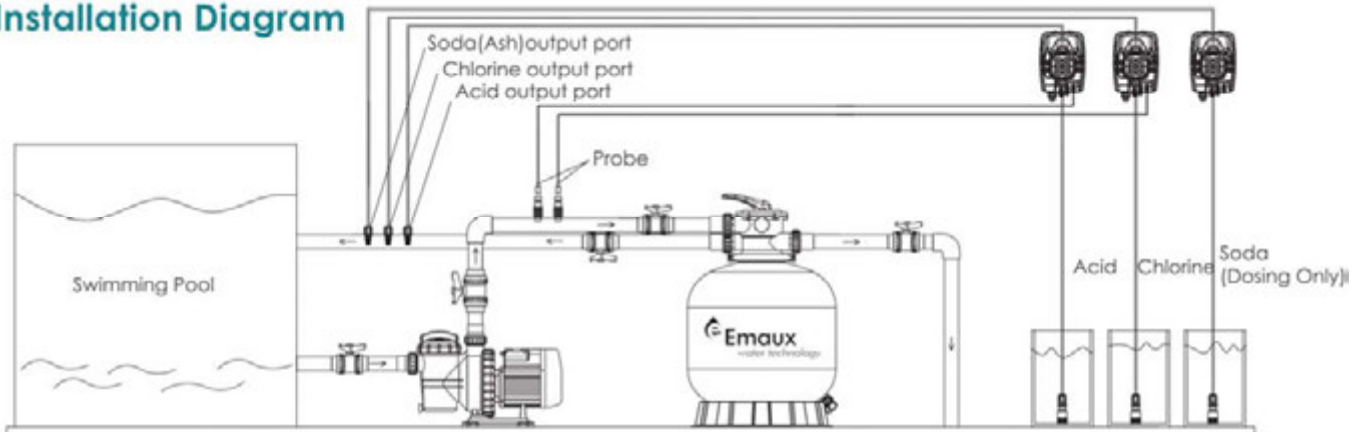

Code	Model	Pressure (bar)	Max Flow/ Hour (l/h)	Stroke Capacity (cc/stroke)	Connection Size In& Outlet (mm)	Frequency Max (stroke/ min)	Power Consumption (Watts)	Retail Price	Code✘
20900510020	CTRL4-PH	12	4	0.42	4 / 6	160	20	32,000.00	H★
20900510030	CTRL4-ORP	8	6	0.63					
20900510040	CTRL7-PH	12	7	0.36	8 / 12	320	40	35,000.00	
20900510050	CTRL7-ORP	5	15	0.78					
20900510060	CTRL20-PH	5	20	1.11	300	40	38,000.00		
20900510070	CTRL20-ORP	2	38	2.11				41,000.00	

หมายเหตุ : ราคายังไม่รวมภาษี 7% บริษัทฯ ขอสงวนสิทธิ์ในการเปลี่ยนแปลงราคาโดยไม่ต้องแจ้งให้ทราบล่วงหน้า  
Remarks : Excluded VAT 7%. The Company reserves the right to change the prices without announcement.



# “EMAUX” CTRL Series Spare Part Accessories

Code	Model	Parameter	Retail Price	Code✕
20910510005	pH Probe	Pressures : 7 bars Material : Epoxy Resin Measure Range : 0 – 14 (with 6 meters signal line) Electrode Diameter : 12 mm (Include probe holder)	14,200.00	B
20910510010	ORP Probe	Pressures : 7 bars Material : Epoxy Resin Measure Range : 1200mV (with 6 meters signal line) Electrode Diameter : 12 mm (Include probe holder)	14,200.00	
Code	Model	Parameter	Retail Price	Code✕
24001610115	pH Probe Buffer Solution	2 bottles of buffer solution of pH (pH4.00 and pH 7.00) + 1 bottle of buffering	3,700.00	B
Code	Model	Parameter	Retail Price	Code✕
20910510015	ORP Probe Buffer Solution	1 bottle of ORP buffer solution (465mV) for 50 ml bottle	2,900.00	B
Code	Model	Parameter	Retail Price	Code✕
20910510020	Dosing Pipe Fittings for CTRL4 / CTRL7	Pressures : 7 bars Material : PVC	3,900.00	B
20910510025	Dosing Pipe Fittings for CTRL20	Screw Size : 1/2" The maximum resistance at: 60C	3,900.00	
Code	Model	Parameter	Retail Price	Code✕
20910510030	Fixed Accessories	Vertical base and wall-mounted accessories	1,900.00	B



# Feeder Accessories

Code	Model	Product	Description	Retail Price	Code✕
21033000005	PZD-300-VTCF-HW	Chemical Feeder Pumps	5– 21 Liters / Hour	42,000.00	A
21033000010	PZD-500-VTCF-HW		27 – 32 Liters / Hour	40,000.00	
21033000015	0.18 kW / 900 RPM / 3PH	Chemical Stirrers	For Tank 200 liters	28,000.00	
21033000020	0.37 kW / 1400 RPM / 1PH		For Tank 500 liters	38,000.00	
21033000060	0.37 kW / 900 RPM / 3PH		For Tank 500 liters	28,000.00	
21033000065	0.37 kW / 300 RPM / 3PH		For Tank 1000 liters	93,000.00	
21033000030	PE-T-100	P.E. Tanks	100 Liters	3,360.00	
21033000035	PE-T-200		200 Liters	4,600.00	
21033000045	PE-T-500		500 Liters	9,200.00	
21033000055	PE-T-1000		1,000 Liters	17,400.00	

หมายเหตุ : ราคายังไม่รวมภาษี 7% บริษัทฯ ขอสงวนสิทธิ์ในการเปลี่ยนแปลงราคาโดยไม่ต้องแจ้งให้ทราบล่วงหน้า  
Remarks : Excluded VAT 7%. The Company reserves the right to change the prices without announcement.

# UNDERWATER LIGHTS





# e-Lumen X

## TRUE COLOR RGB WITH WARM WHITE AND COOL WHITE LED

Waterproof Standard

**IP68**

Cable

**2.5m**

Installation

**Concrete Wall Mount / Retrofit  
Concrete Niche / Fiberglass / Vinyl Pool**

Installation

**Plastic ABS/Stainless Steel/Transparent**

Color



RGB



LED Blue



LED Warm White



LED Cool White

1. The light incorporates five basic colors of LED chips: cool white, warm white, red-green-blue (RGB), with high power and constant color rendering over time and temperature.
2. Equipped with state-of-the-art LED technology, E-Lumen X ensures increased energy and luminous efficacy achieving 80 lumens per watt.
3. Bulb life exceeds 40,000 hours.
4. The innovative design of the diffusion lens and bulb matrix provides exceptional reflection, brightness, throw, and angle of illumination.
5. The perforations on the face ring contribute to the light intensity and angle of illumination by allowing a light penetration throughout.
6. Self determined operation mode with or without Color-Touch controller.
7. Automatic color synchronization among lights and zone.



# “EMAUX” E-Lum LED Underwater Light Wall Hang Type

ES

TRUE COLOR RGB WITH WARM WHITE AND COOL WHITE LED. QUICK, EASY AND DIRECT REPLACEMENT WITH A RETROFIT CONNECTOR

### Features

- High energy efficiency and lumen rate.
- Innovative designs of the diffusion lens and bulb matrix provide exception reflection, brightness and angle of illumination.
- Longevity lasts for more than 9,000 hours
- The drilled holes on the face ring also contribute to the light intensity and angle of illumination by allowing light penetration throughout.
- ColorTouch Light Control Box with Remote Controller provides direct light color change and two zones synchronized color control.

### LED PANEL LIFE TIME

- 0-9000 hrs at 95% efficiency,
- 9001 - 23000 hrs at 85% efficiency,
- after 23000 hrs, the efficiency will less than 85%

- Waterproof Standard** IP68
- Face Ring Material** ABS/Stainless Steel
- Cable** 2.5m
- Installation** Wall Hang

Pool Light Protection Rating : IP68 to 2m depth  
Power Consumption :25W

Color	Operation Voltage	illuminance (Lux)	Color Temperature
Cool White	12~32V AC 50/60Hz	350	6500K
Warm White	12~32V AC 50/60Hz	325	3000K

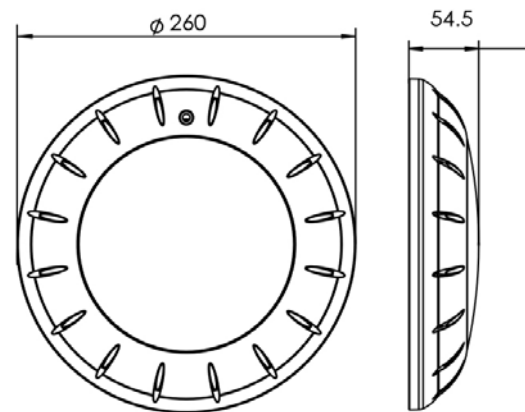
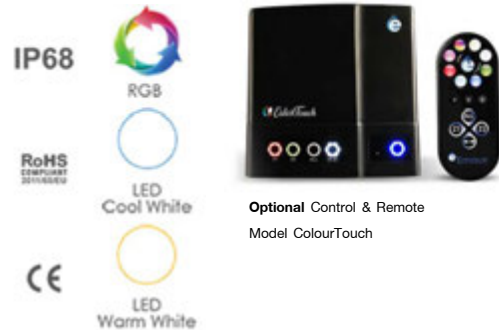



True Colour RGB with Warm White & Cool White LED  
Synchronize colour settings of 2 zone by ColourTouch control System



### Face Ring Color Options



Description	Face Ring
E-Lumen X Light 12~32V AC 50/60Hz	White
E-Lumen X Light 12~32V AC 50/60Hz	Grey
E-Lumen X Light 12~32V AC 50/60Hz	Blue
E-Lumen X Light 12~32V AC 50/60Hz	Stainless Steel

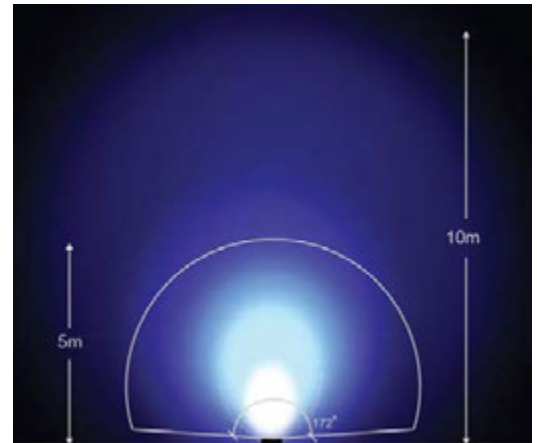

Angle and distance of illumination



Cable 2.5 Meter / Waterproof Standard: IP68

Code	Model	Watt/Voltage	Face Plate	Retail Price	Code✖
21100510426	E-LumenX-WF-L	RGB Warm White Cool White LED 25W/12V	White	11,900.00	H★
2110510430	E-LumenX-GF-L		Gray	11,900.00	
2110510436	E-LumenX-BF-L		Blue	11,900.00	
2110510441	E-LumenX-SS316-L		S.S.316	14,900.00	

หมายเหตุ : ราคายังไม่รวมภาษี 7% บริษัทฯ ขอสงวนสิทธิ์ในการเปลี่ยนแปลงราคาโดยไม่ต้องแจ้งให้ทราบล่วงหน้า  
Remarks : Excluded VAT 7%. The Company reserves the right to change the prices without announcement.



# “EMAUX” E-Lumen X ZIRC LED Underwater Lights Built-In Type

## HIGH ENERGY EFFICIENCY AND LUMINATION

ZIRCON is a powerful 25W LED light engineered for fiberglass pools. The niche or the locknut design provides a secure and flexibility enabling a quality installation.

## FEATURES

- High energy efficiency and lumen rate.
- Innovative designs of the diffusion lens and bulb matrix provide exception reflection, brightness and angle of illumination.
- Longevity lasts for more than 9,000 hours
- The drilled holes on the face ring also contribute to the light intensity and angle of illumination by allowing light penetration throughout.
- ColorTouch Light Control Box with Remote Controller provides direct light color change and two zones synchronized color control.



- Waterproof Standard** IP68
- Face Ring Material** ABS
- Cable** 2.5m
- Installation** Built-In

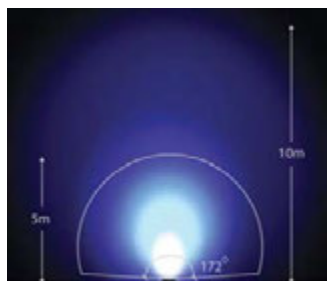

Angle and distance of illumination

Zircon Light 12Vac 50/60Hz, Power cord length with retrofit connector: 2.5m

Model	Maximum Power	illuminance (Lux)	Color Temperature
ZIR25-C	25W	325 (Warm White)	3000K
ZIR25-V	25W	350 (Cool White)	6500K

Cable 2.5 Meter / Waterproof Standard: IP68

Code	Model	Watt/Voltage	Face Plate	Retail Price	Code✖
21100510485	ZIR25-C	RGB Warm White	Transparent	9,000.00	H★
21100510490	ZIR25-V	Cool White LED 25W/12V	Transparent	9,000.00	



Optional Control & Remote Model ColourTouch

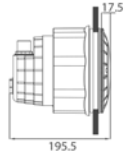
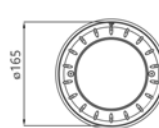

หมายเหตุ : ราคายังไม่รวมภาษี 7% บริษัทฯ ขอสงวนสิทธิ์ในการเปลี่ยนแปลงราคาโดยไม่ต้องแจ้งให้ทราบล่วงหน้า  
Remarks : Excluded VAT 7%. The Company reserves the right to change the prices without announcement.



# “EMAUX” E-Lumen X TOPAZ Series LED Underwater Lights Built-In Type

## SLIM FIT LED LIGHT FOR MULTI-INSTALLATION

TOPAZ is a compact and powerful 13W LED light. Its slim construction and multi-installation mechanisms allow it to be fitted into pools and spas of any dimensions, providing a superb lighting effect.

## FEATURES

- High energy efficiency and lumen rate.
- Innovative designs of the diffusion lens and bulb matrix provide exception reflection, brightness and angle of illumination.
- Longevity lasts for more than 9,000 hours
- The drilled holes on the face ring also contribute to the light intensity and angle of illumination by allowing light penetration throughout.
- ColorTouch Light Control Box with Remote Controller provides direct light color change and two zones synchronized color control.

- Waterproof Standard** IP68
- Face Ring Material** ABS
- Cable** 2.5m
- Installation** Built-in

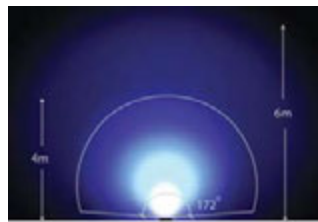

Angle and distance of illumination



Optional Control & Remote  
Model ColourTouch

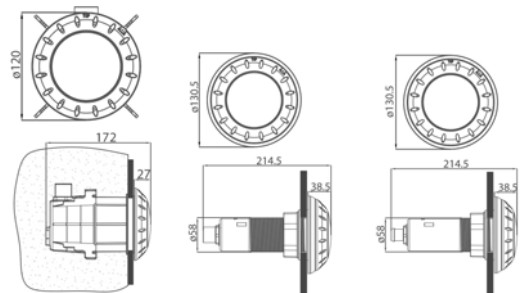

TOPAZ light 12Vac 50/60Hz, Power cord length with retrofit connector: 2.5m

Code	Model	Maximum Power	illuminance (Lux)	Color Temperature
9042701	TOP13-C	13W	220 (Warm White)	3000K
9042702	TOP13-VL	13W	200 (Cool White)	6500K
9042703	TOP13-VS	13W		

Cable 2.5 Meter / Waterproof Standard: IP68

Code	Model	Watt/Voltage	Face Plate	Retail Price	Code✳
21100510495	TOP13-C	RGB Warm White Cool White LED 13W-12V	Transparent	7,900.00	H★
21100510500	TOP13-VL		Transparent	7,900.00	
21100510505	TOP13-VS		Transparent	7,900.00	

หมายเหตุ : ราคายังไม่รวมภาษี 7% บริษัทฯ ขอสงวนสิทธิ์ในการเปลี่ยนแปลงราคาโดยไม่ต้องแจ้งให้ทราบล่วงหน้า  
Remarks : Excluded VAT 7%. The Company reserves the right to change the prices without announcement.



# “EMAUX” E-Lumen X EAGLE EYE Series LED Underwater Lights Built-In Type

## ULTRA SLIM FIT NICHELESS LED POOL LIGHT

EAGLE EYE is a slim, high efficiency LED light with a powerful 18W output. The nicheless design allows for installation in 1.5 inch/50mm PVC pipes, suction fittings, or wall conduits. An easy-change lens cover provides a handy option for switching lighting effects.

### ADVANTAGES

- Innovative convection design
- The flexibility of smaller size
- Long operational lifespan
- Ultimate glowing
- Multi-installation mechanisms
- Wireless color change
- Friendly accessories



Optional Control & Remote  
Model ColourTouch



RGB



LED Cool White



LED Warm White

<b>Waterproof Standard</b>	IP68
<b>Material</b>	PC + ABS
<b>Cable</b>	2 / 15 / 30 / 45 m.
<b>Installation</b>	Built-In

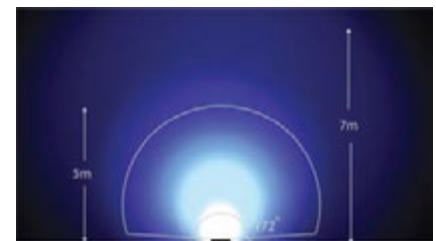

Angle and distance of illumination

### Product Information:

Code	Model	Cable Length	Description	Illuminance
9043001	EAG18	7/50/100/150 ft 2/15/30/45 m	Eagle Eye Nicheless LED Light 2White+RGB, 18W / 12V AC	278 Lux

### Installations:

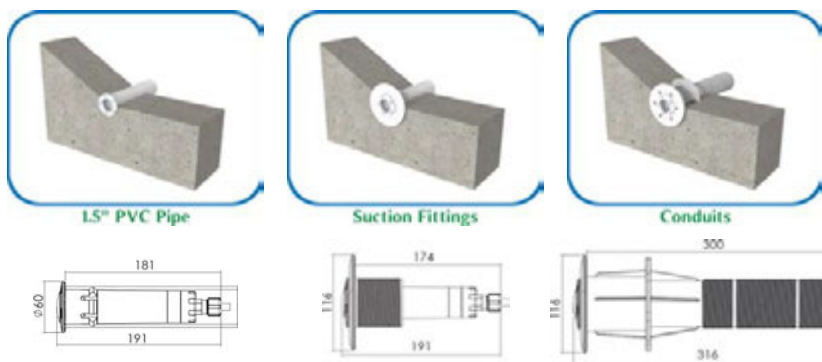

### Lens Covers



Cable 2, 15, 30, 45 m. / Waterproof Standard: IP68

Code	Model	Watt/Voltage	Face Plate	Retail Price	Code✖
21100510550	EAG18	RGB Warm White Cool White LED 18W/12V	White	5,900.00	H★

หมายเหตุ : ราคายังไม่รวมภาษี 7% บริษัทฯ ขอสงวนสิทธิ์ในการเปลี่ยนแปลงราคาโดยไม่ต้องแจ้งให้ทราบล่วงหน้า  
Remarks : Excluded VAT 7%. The Company reserves the right to change the prices without announcement.



# “EMAUX” E-LUMEN Series LED Underwater Lights Wall Hang Type

With the best LED technology, Nicheless E-Lumen mounts directly on the wall for simple installation. Only required few bolts, this is the most convenience choice of professional underwater light.

### TECHNOLOGY & FEATURE

- Direct wall-mount design for simple installation
- Concrete & Vinyl Pool Compatible
- Light-duty of power usage works well with any standard of your existing transformer

<b>Waterproof Standard</b>	IP68
<b>Face Ring Material</b>	ABS + UV stabilizer
<b>Cable</b>	2.5m
<b>Installation</b>	Wall hang

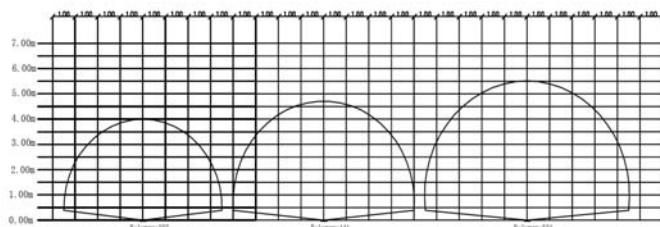

### Light Color:

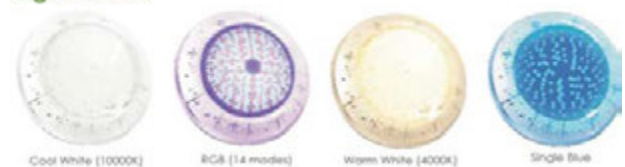

### Product Information

Model	LED Bulb	Watt/ Voltage	Illuminance (lux)	Color
E-Lumen-252	252 LEDs Bulb	20W/12V	346	Cool White (10000K)
E-Lumen-252	252 LEDs Bulb	20W/12V	415	Warm White (4000K)
E-Lumen-252	252 LEDs Bulb	20W/12V	52	Blue
E-Lumen-252	252 LEDs Bulb	20W/12V	166	RGB
E-Lumen-441	441 LEDs Bulb	35W/12V	550	Cool White (10000K)
E-Lumen-441	441 LEDs Bulb	35W/12V	613	Warm White (4000K)
E-Lumen-441	441 LEDs Bulb	35W/12V	78	Blue
E-Lumen-441	441 LEDs Bulb	35W/12V	273	RGB
E-Lumen-531	531 LEDs Bulb	50W/12V	608	Cool White (10000K)
E-Lumen-531	531 LEDs Bulb	50W/12V	634	Warm White (4000K)
E-Lumen-531	531 LEDs Bulb	50W/12V	158	Blue
E-Lumen-531	531 LEDs Bulb	50W/12V	316	RGB

### Simple installation

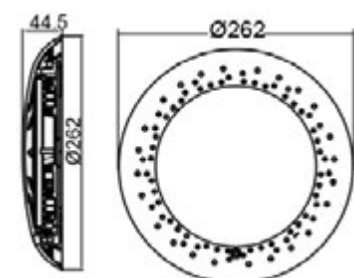

# PRICE LIST 2023

# UNDERWATER LIGHTS



### Cable 2.5 Meter / Waterproof Standard: IP68

Code	Model	Watt/Voltage	LED	LUX	Colour	Retail Price	Code✖
21100510005	E-Lumen-252-RGB-L	20W/12V	252	166	Multi Colour (14 Modes)	8,900.00	H★
21100510010	E-Lumen-252-WW-L			415	Warm White (4000K)	8,900.00	
21100510015	E-Lumen-252-CW-L			346	Cool White (20000K)	8,900.00	
21100510510	E-Lumen-252-BLUE-L			52	Blue	8,900.00	

### Cable 2.5 Meter / Waterproof Standard: IP68

Code	Model	Watt/Voltage	LED	LUX	Colour	Retail Price	Code✖
21100510020	E-Lumen-441-RGB-L	35W/12V	441	273	Multi Colour (14 Modes)	10,900.00	H★
21100510025	E-Lumen-441-WW-L			613	Warm White (4000K)	10,900.00	
21100510030	E-Lumen-441-CW-L			550	Cool White (20000K)	10,900.00	

### Cable 2.5 Meter / Waterproof Standard: IP68

Code	Model	Watt/Voltage	LED	LUX	Colour	Retail Price	Code✖
21100510035	E-Lumen-531-RGB-L	50W/12V	531	316	Multi Colour (14 Modes)	12,900.00	H★
21100510040	E-Lumen-531-WW-L			634	Warm White (4000K)	12,900.00	
21100510045	E-Lumen-531-CW-L			608	Cool White (20000K)	12,900.00	

### LED Panel Spare Parts

KEY NO.	POOLSPA CODES	PART NO.	DESCRIPTIONS	PIECE (S) REQUIRED	RETAIL PRICE 2023
4	21130510085	89045528	UltraThin LED Panel 20W/12V for 252 LED (Warm white)	1	5,900.00
4	21130510090	89045529	UltraThin LED Panel 20W/12V for 252 LED (Cool white)	1	5,900.00
4	21130510095	89045530	UltraThin LED Panel 20W/12V for 252 LED (RGB)	1	5,900.00
4	21100510435	89045531	UltraThin LED Panel 20W/12V for 252 LED (Single blue)	1	5,900.00
4	21130510100	89045522	UltraThin LED Panel 35W/12V for 441 LED (Warm white)	1	6,900.00
4	21130510105	89045513	UltraThin LED Panel 35W/12V for 441 LED (Cool white)	1	6,900.00
4	21130510110	89045514	UltraThin LED Panel 35W/12V for 441 LED (RGB)	1	6,900.00
4	21110510895	89045523	UltraThin LED Panel 35W/12V for 441 LED (Single blue)	1	6,900.00
4	21130510115	89045524	UltraThin LED Panel 50W/12V for 531 LED (Warm white)	1	8,500.00
4	21130510120	89045526	UltraThin LED Panel 50W/12V for 531 LED (Cool white)	1	8,500.00
4	21130510125	89045527	UltraThin LED Panel 50W/12V for 531 LED (RGB)	1	8,500.00
4	21110510900	89045525	UltraThin LED Panel 50W/12V for 531 LED (Single blue)	1	8,500.00

หมายเหตุ : ราคายังไม่รวมภาษี 7% บริษัทฯ ขอสงวนสิทธิ์ในการเปลี่ยนแปลงราคาโดยไม่ต้องแจ้งให้ทราบล่วงหน้า  
 Remarks : Excluded VAT 7%. The Company reserves the right to change the prices without announcement.



# “EMAUX” EL-COMP Series LED Underwater Lights Built-In Type

E-Lumen-Compact carries the latest resin-filled LED panel in the market. It has the most energy efficiency and luminous efficiency technology. The E-Lumen Compact has different setting. The nicheless version is designed for fiberglass pool or steel panel pool with liner. While the niche version is suitable for concrete installation

### FEATURES

- Resin-filled LED panel allows 100% water proofing
- Concrete, Vinyl Pool, Fiberglass Pool & Liner Pool Compatible
- Durable ABS structure with high quality PC transparent lid
- IP 68 waterproof standard



Optional  
Control & Remote  
Model 08040009

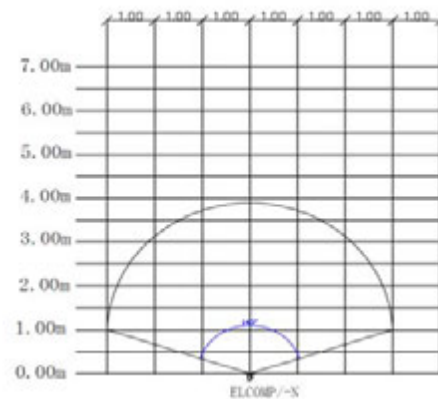
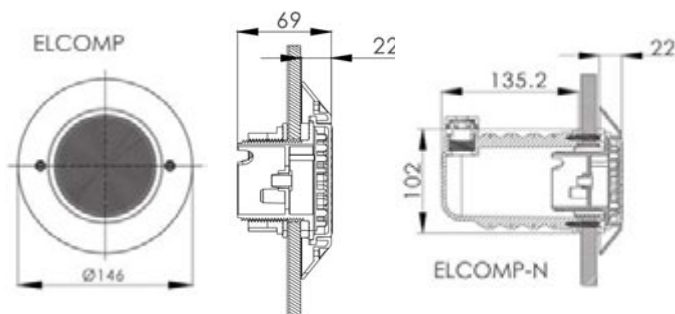

## Product Specifications

Model No.	Description	Watt/Voltage	Illuminance (lux)	Remarks
EL-COMP-N	Plastic Light with Housing, 99 LEDs RGB	10W/12V	90	RGB
EL-COMP-N	Plastic Light with Housing, 99 LEDs Cool White	10W/12V	200	Cool White
EL-COMP-N	Plastic Light with Housing, 99 LEDs Warm White	10W/12V	212	Warm White
EL-COMP-N	Plastic Light with Housing, 99 LEDs Single Blue	10W/12V	20	Single Blue
EL-COMP	Plastic Light Nicheless, 99 LEDs RGB	10W/12V	90	RGB
EL-COMP	Plastic Light Nicheless, 99 LEDs Cool White	10W/12V	200	Cool White
EL-COMP	Plastic Light Nicheless, 99 LEDs Warm White	10W/12V	212	Warm White
EL-COMP	Plastic Light Nicheless, 99 LEDs Single Blue	10W/12V	20	Single Blue



**Installation**

**1) NICHE VERSION**

a) Concrete Pool

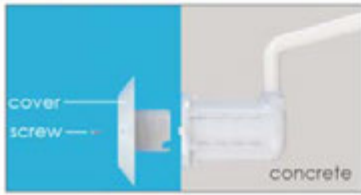

b) Concrete Pool with Liner

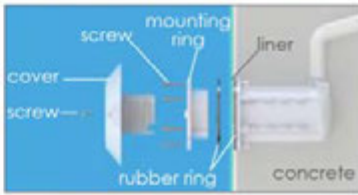

**Cable 2.5 Meter / Waterproof Standard: IP68**

Code	Model	Watt/Voltage	LED	LUX	Colour	Retail Price	Code✳
21100510050	EL-COMP-N-RGB-L	10W/12V Concrete Pool	99	90	Multi Colour (14 Modes)	7,500.00	H★
21100510055	EL-COMP-N-WW-L			212	Warm White (4000K)	7,500.00	
21100510060	EL-COMP-N-CW-L			200	Cool White (20000K)	7,500.00	
21100510515	EL-COMP-N-BLUE-L			20	Blue	7,500.00	

**2) NICHELESS VERSION**

a) Fiberglass Pool

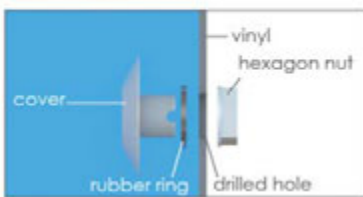

b) Steel Panel Pool with Liner

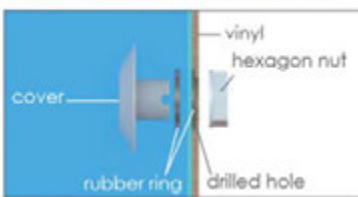

**Cable 2.5 Meter / Waterproof Standard: IP68**

Code	Model	Watt/Voltage	LED	LUX	Colour	Retail Price	Code✳
21100510065	EL-COMP-RGB-L	10W/12V Vinyl Pool	99	90	Multi Colour (14 Modes)	7,500.00	H★
21100510070	EL-COMP-WW-L			212	Warm White (4000K)	7,500.00	
21100510075	EL-COMP-CW-L			200	Cool White (20000K)	7,500.00	
21100510520	EL-COMP-BLUE-L			20	Blue	7,500.00	

**LED Panel Spare Parts**

KEY NO.	POOLSPA CODES	PART NO.	DESCRIPTIONS	PIECE (S) REQUIRED	RETAIL PRICE 2023
12	21110510905	04011137	LED panel (99 Bulbs) (Cool White) for E-Lumen Compact	1	4,900.00
12	21110510910	04011138	LED panel (99 Bulbs) (Automatic Colour change) for E-Lumen Compact	1	4,900.00
12	21110510915	04011139	LED panel (99 Bulbs) (Warm White) for E-Lumen Compact	1	4,900.00
12	21110510920	04011140	LED panel (99 Bulbs) (Blue colour) for E-Lumen Compact	1	4,900.00

หมายเหตุ : ราคายังไม่รวมภาษี 7% บริษัทฯ ขอสงวนสิทธิ์ในการเปลี่ยนแปลงราคาโดยไม่ต้องแจ้งให้ทราบล่วงหน้า  
 Remarks : Excluded VAT 7%. The Company reserves the right to change the prices without announcement.





# “EMAUX” EL-S300 Series LED Underwater Lights Built-in or Wall Mount Type

### TECHNOLOGY & FEATURES

- Resin-filled LED Panel
- Stainless steel 304 face ring
- Simple installation & durable
- Various colour options & Pre-programmed lighting effects
- IP 68 Waterproof Standard

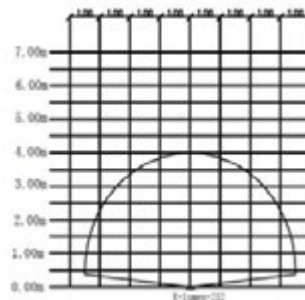

IP68

RoHS

CE



Optional  
Control & Remote  
Model 08040009

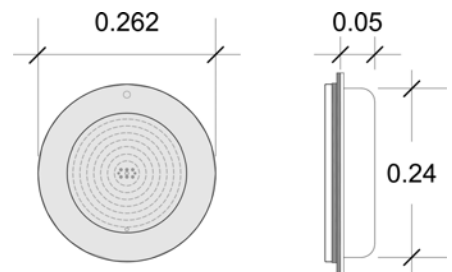

Cable 2.5 Meter / Waterproof Standard: IP68

Code	Model	Material	W/V	LED	LUX	Colour	Option	Retail Price	Code✘
21100510155	EL-S300L-252-304-RGB	S.S. 304	20W /12V	252	220	Multi Colour (14 Modes)	Light & Niche	11,200.00	H★
2174100011									
2170160317									
21100510160	EL-S300L-252-304-WW				535	Warm White (4000K)	Light & Niche	11,200.00	
2174100011									
2170160317									
21100510165	EL-S300L-252-304-CW				450	Cool White (20000K)	Light & Niche	11,200.00	
2174100011									
2170160317									
21100510170	EL-S300L-252-304-BLUE	64	Blue	Light & Niche	11,200.00				
2174100011									
2170160317									



Code	Model	Description	Retail Price	Code✘
2174100011	Ring Light-EL-S300	Plastic Ring for Light Model S300	350.00	B★
2170160317	Niche-EL-S300	Fiber Glass Niche Dia 29.00 cm x Depth 5.00 cm	1,200.00	
21121610010	FP-EL-S300	Fiber Glass Face Plate For EL-S300	1,500.00	

หมายเหตุ : ราคายังไม่รวมภาษี 7% บริษัทฯ ขอสงวนสิทธิ์ในการเปลี่ยนแปลงราคาโดยไม่ต้องแจ้งให้ทราบล่วงหน้า

Remarks : Excluded VAT 7%. The Company reserves the right to change the prices without announcement.



# “EMAUX” EL-S100 Series LED Underwater Lights Built-in or Wall Mount Type



IP68

RoHS

CE

**TECHNOLOGY & FEATURES**

- Resin-filled LED Panel
- Stainless steel 304 face ring
- Simple installation & durable
- Various colour options & Pre-programmed lighting effects
- IP 68 Waterproof Standard



Optional  
Control & Remote  
Model 08040009

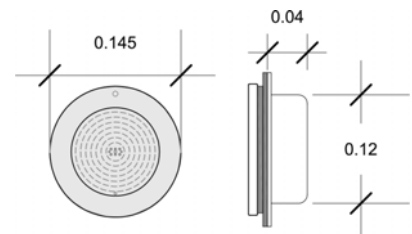

Cable 2.5 Meter / Waterproof Standard: IP68

Code	Model	Material	W/V	LED	LUX	Colour	Include	Retail Price	Code✘
21110051045	EL-S100-304-RGB	S.S. 304	10W /12V	99	90	Multi Colour (14 Modes)	Light & Niche	6,900.00	H★
2174100012									
2170160316									
21100510455	EL-S100-304-WW				200	Warm White (4000K)	Light & Niche	6,900.00	
2174100012									
2170160316									
21100510465	EL-S100-304-CW				200	Cool White (20000K)	Light & Niche	6,900.00	
2174100012									
2170160316									
21100510525	EL-S100-304-BLUE	64	Blue	Light & Niche	6,900.00				
2174100012									
2170160316									

Code	Model	Description	Retail Price	Code✘
2174100012	Ring Light-EL-S100	Plastic Ring for Light Model S100	290.00	H★
2170160316	Niche-EL-S100	Fiber Glass Niche Dia 17.5 cm x Depth 6.00 cm.	1,000.00	
21121610015	FP-EL-S100	Fiber Glass Face Plate For EL-S100	1,000.00	



**LED Panel Spare Parts**

KEY NO.	POOLSPA CODES	PART NO.	DESCRIPTIONS	PIECE (S) REQUIRED	RETAIL PRICE 2023
3	21110510945	440546196	Ultra-thin 99 LED panel 10W Warm White	1	4,900.00
3	21110510950	440546195	Ultra-thin 99 LED panel 10W Cool White	1	4,900.00
3	21110510955	440546197	Ultra-thin 99 LED panel 10W RGB	1	4,900.00
3	21110510960	440546198	Ultra-thin 99 LED panel 10W Single Blue	1	4,900.00

หมายเหตุ : ราคายังไม่รวมภาษี 7% บริษัทฯ ขอสงวนสิทธิ์ในการเปลี่ยนแปลงราคาโดยไม่ต้องแจ้งให้ทราบล่วงหน้า  
Remarks : Excluded VAT 7%. The Company reserves the right to change the prices without announcement.



# “EMAUX” NP300 Series Halogen Underwater Lights Built-In Type

### FEATURES

- Halogen or bulb
- Suitable for concrete, vinyl and fiberglass pool
- Waterproof: IP68
- Installation: Housing Type
- Cable length: 2.5 meters

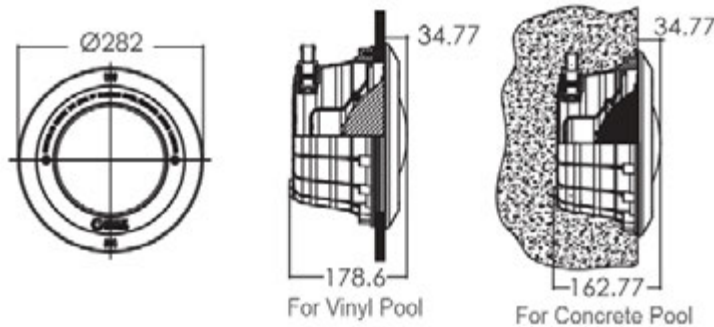

IP68 RoHS COMPLIANT 2011/65/EU CE SAA  
UL White

Model	Face Ring	Light	Watt/Voltage	Color	Illumiance (lux)	Remote Control
NP300-P	Plastic	PAR56 Light Bulb	300W/12V	Warm White	9300	No

### Cable 2.5 Meter / Waterproof Standard: IP68

Code	Model	Material	Bulb Type	W/V	LUX	Colour	Include	Retail Price	Code✘
2110510190	UL-NP300-P	Plastic Face Ring	Par 56	300W /12V	9300	Warm White	Light & Niche	4,700.00	H★

### Light Bulb Spare Parts

KEY NO.	POOLSPA CODES	PART NO.	DESCRIPTIONS	PIECE (S) REQUIRED	RETAIL PRICE 2023
5	21130510005	04011004	PAR56 Light Bulb (Yellow Light) (Standard Bulb)	1	990.00
5	21110510725	08040026	Par56(144 LEDs,12V/10W,Auto RGB)	2	4,900.00
5	21110510715	08040025	Par56(144 LEDs,12V/10W,Cool White)	3	4,900.00
5	21130510075	08040024	Par56(252 LEDs,12V/16W,Auto RGB)	4	7,900.00
5	21130510080	08040022	Par56 252 LED Bulbs (White-Colour)	5	7,900.00
5	21110510710	08040023	Par56 252 LED Bulbs (With Remote Control)	6	7,900.00

หมายเหตุ : ราคายังไม่รวมภาษี 7% บริษัทฯ ขอสงวนสิทธิ์ในการเปลี่ยนแปลงราคาโดยไม่ต้องแจ้งให้ทราบล่วงหน้า  
Remarks : Excluded VAT 7%. The Company reserves the right to change the prices without announcement.



# “EMAUX” LED-NP300 Series LED Underwater Lights Built-In Type

Ultra-Thin 400 LED



Optional  
Control & Remote  
Model 08040009

IP68

RoHS  
COMPLIANT  
2011/65/EU

CE

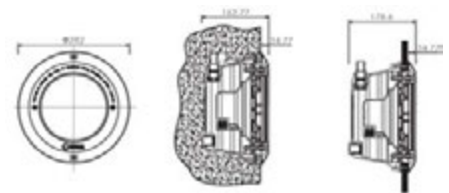

## Stainless Steel 304 Face Ring

Cable 2.5 Meter / Waterproof Standard: IP68

Code	Model	Material	W/V	LED	LUX	Colour	Include	Retail Price	Code✕
21100510215	EL-NP300-S-252-304-RGB	S.S 304 Face Ring	20W/ 12V	252	220	Multi Colour (14 Modes)	Light & Niche	12,700.00	H★
21100510220	EL-NP300-S-252-304-WW				535	Warm White (4000K)	Light & Niche	12,700.00	
21100510225	EL-NP300-S-252-304-CW				450	Cool White (20000K)	Light & Niche	12,700.00	

## Plastic Face Ring

Code	Model	Material	W/V	LED	LUX	Colour	Include	Retail Price	Code✕
21100510230	EL-NP300-P-252-RGB	Plastic Face Ring	20W/ 12V	252	222	Multi Colour (14 Modes)	Light & Niche	11,500.00	H★
21100510235	EL-NP300-P-252-WW				535	Warm White (4000K)	Light & Niche	11,500.00	
21100510240	EL-NP300-P-252-CW				450	Cool White (20000K)	Light & Niche	11,500.00	

หมายเหตุ : ราคายังไม่รวมภาษี 7% บริษัทฯ ขอสงวนสิทธิ์ในการเปลี่ยนแปลงราคาโดยไม่ต้องแจ้งให้ทราบล่วงหน้า  
Remarks : Excluded VAT 7%. The Company reserves the right to change the prices without announcement.



# “EMAUX” LED-TP100 Series LED Underwater Lights Wall Mount Type

**FEATURES**

- Resin-filles LED panel allows 100% water proofing

<b>Waterproof Standard</b>	IP68
<b>Face Ring Material</b>	ABS + UV stabilizer
<b>Cable</b>	2.5m
<b>Installation</b>	Wall Mounted

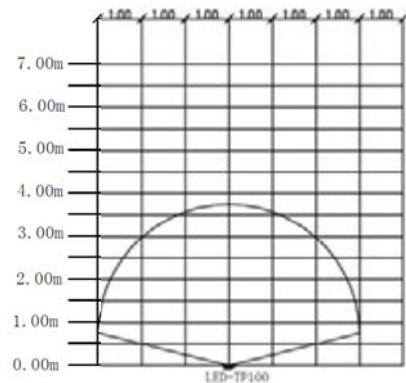
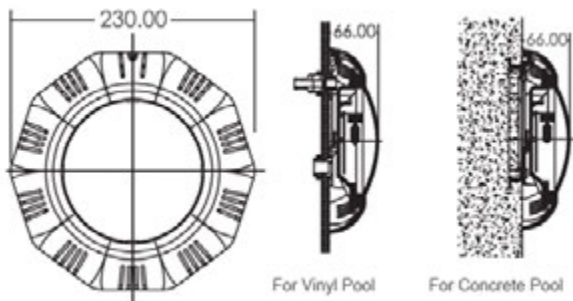

**TP100 Series LED Light Color Changing**



Model	Light	Watt/ Voltage	Color	Illuminance (lux)
LED-TP100 198 LEDs Light Panel		8W/12V	Cool White	180(cool white)
LED-TP100 198 LEDs Light Panel		8W/12V	Auto color changing	250(color)
LED-TP100 198 LEDs Light Panel		8W/12V	Blue	120(blue)

**Cable 2.5 Meter / Waterproof Standard: IP68**

Code	Model	Material	Bulb Type	W/V	LUX	Colour	Retail Price	Code✳
21100510095	LED-TP100-CW	Plastic	198 Bulbs LED Panel	8W/ 12V	180	Cool White	5,990.00	H★
21100510470	LED-TP100-WW				207	Warm White	5,990.00	
21100510100	LED-TP100-RGB				250	Auto Color Change	5,990.00	
21100510440	LED-TP100-BLUE				120	Blue	5,990.00	

**Light Bulb Spare Parts**

KEY NO.	POOLSPA CODES	PART NO.	DESCRIPTIONS	PIECE (S) REQUIRED	RETAIL PRICE 2023
3	21130510060	04011109	Bulb plate 12V/8W 198LEDs For white Colour Only	1	4,900.00
3	21130510055	04011110	Bulb plate 12V/8W 198LEDs For Colour-changing Only	1	4,900.00
3	21110511020	04011113	Bulb plate 12V/8W 198LEDs For Blue Colour Only	1	4,900.00

หมายเหตุ : ราคายังไม่รวมภาษี 7% บริษัทฯ ขอสงวนสิทธิ์ในการเปลี่ยนแปลงราคาโดยไม่ต้องแจ้งให้ทราบล่วงหน้า  
Remarks : Excluded VAT 7%. The Company reserves the right to change the prices without announcement.



# “EMAUX” UL-P100 Series Halogen Underwater Lights Wall Mount Type

- Waterproof Standard** IP68
- Face Ring Material** ABS + UV Stabilizer
- Cable** 2.5m
- Installation** Wall Mounted (Flat Type)

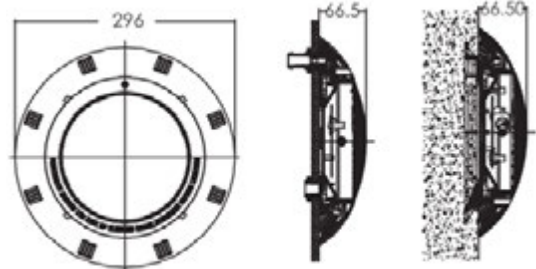
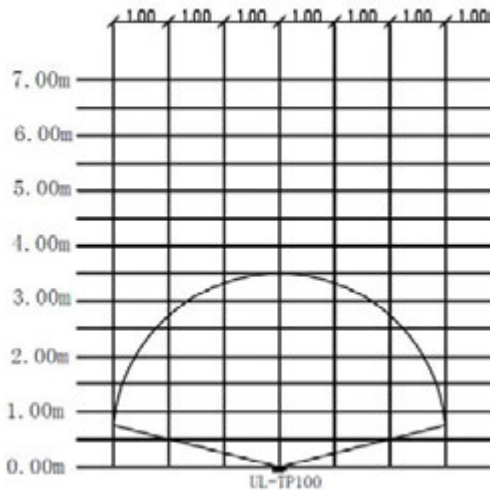

For Vinyl Pool For Concrete Pool

Cable 2.5 Meter / Waterproof Standard: IP68

Code	Model	Material	Bulb Type	W/V	LUX	Colour	Retail Price	Code✖
21100510090	UL-P100	Plastic	Halogen	75W/12V	480	Warm White	2,990.00	H★

### Light Bulb Spare Parts

KEY NO.	POOLSPA CODES	PART NO.	DESCRIPTIONS	PIECE (S) REQUIRED	RETAIL PRICE 2023
8	21130510025	E040205	Halogen light bulb (Yellow Light / 75W/12V)	1	150.00
8	21130110010	G9 - 100	Halogen light bulb (100W/12V)	1	220.00

หมายเหตุ : ราคายังไม่รวมภาษี 7% บริษัทฯ ขอสงวนสิทธิ์ในการเปลี่ยนแปลงราคาโดยไม่ต้องแจ้งให้ทราบล่วงหน้า  
Remarks : Excluded VAT 7%. The Company reserves the right to change the prices without announcement.



# “EMAUX” Terra-Lux Series High Power LED Underwater Lights Built-In Type

**ENERGY SAVING, AND A WIDE RANGE OF APPLICATIONS**

This energy saving light is the best solution to save the energy and at the same time generates a high power lamination. The stainless steel AISI-316 material assures optimum corrosion resistance. Its olished Stainless Steel surface is simply classic and elegant. The high gradr ABS plastic housing is also durable and applicable for installation such as in-ground, pool wall, deck surface and steps.



**FEATURES**

- Compatible with underwater installations and floor installations
- Durable ABS Plastic Housing
- AISI-316 Stainless Steel Light
- IP68 Waterproof Standard

IP68   
 
RoHS COMPLIANT 2011/65/EU   
 SAA

LED Cool White   
 
LED Warm White

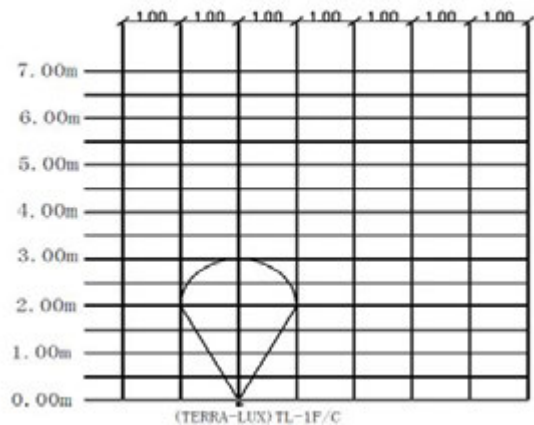



**TL-1C (Wall)**

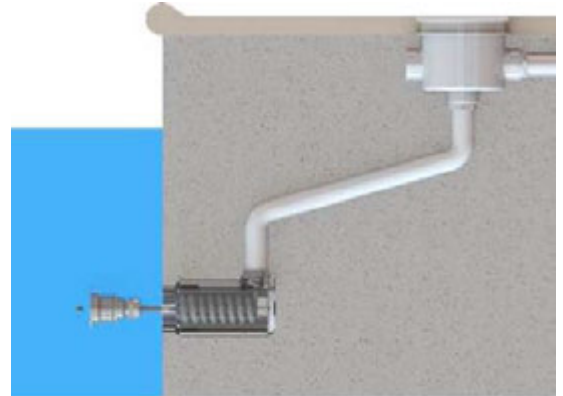
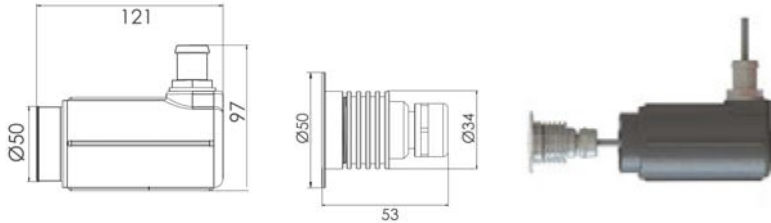

**TL-1C**

**Cable 1.5 Meter / Waterproof Standard: IP68**

Code	Model	Material	Bulb Type	Watt/ Voltage	LUX	Colour	Retail Price	Code✖
21100510270	TL-1C-CW	S.S.316	LED SHIP	3W/12V Wall Installation	140	Cool White	5,200.00	H★
21100510275	TL-1C-WW				198	Warm White	5,200.00	

**TL-1F (Floor)**

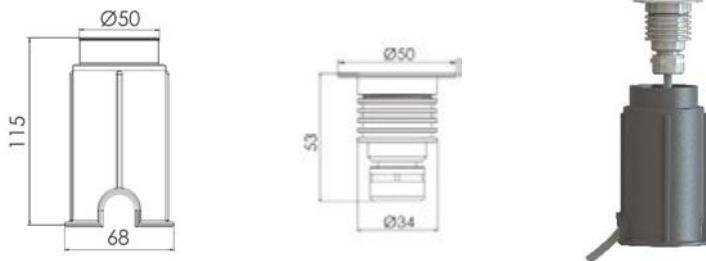

**TL-1F**

**Cable 1.5 Meter / Waterproof Standard: IP68**

Code	Model	Material	Bulb Type	Watt/ Voltage	LUX	Colour	Retail Price	Code✖
21100510280	TL-1F-CW-L	S.S.316	LED SHIP	3W/12V Floor Installation	140	Cool White	5,200.00	H★
21100510285	TL-1F-WW-L				198	Warm White	5,200.00	

**LED Panel Spare Parts**

KEY NO.	POOLSPA CODES	PART NO.	DESCRIPTIONS	PIECE (S) REQUIRED	RETAIL PRICE 2023
4	21110511045	440546573	LED panel Suite(Cool White)	1	1,320.00
4	21110511050	440546574	LED panel Suite(Warm White)	1	1,320.00

หมายเหตุ : ราคายังไม่รวมภาษี 7% บริษัทฯ ขอสงวนสิทธิ์ในการเปลี่ยนแปลงราคาโดยไม่ต้องแจ้งให้ทราบล่วงหน้า  
 Remarks : Excluded VAT 7%. The Company reserves the right to change the prices without announcement.





# “EMAUX” LED-P10 Series LED Underwater Lights Built-In Type

**FEATURES**

- Material : ABS + UV stabilizer
- Cable 3.0 meters
- Waterproof: IP68
- Installation: With slip in 2”/63mm Class 12 PVC pipe

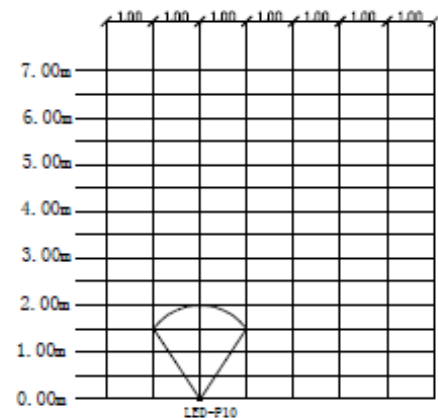
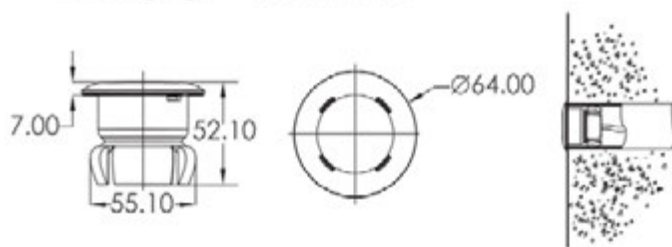

**Cable 3.0 Meter / Waterproof Standard: IP68**

Code	Model	Material	Bulb Type	W/V	LUX	Colour	Retail Price	Code✕
21100510290	LED-P10-CW	Plastic	18 Bulbs	1W/12V	170	Cool white	1,400.00	H★
21100510295	LED-P10-RGB		LED Panel		124	Auto Colour Change	1,400.00	

หมายเหตุ : ราคายังไม่รวมภาษี 7% บริษัทฯ ขอสงวนสิทธิ์ในการเปลี่ยนแปลงราคาโดยไม่ต้องแจ้งให้ทราบล่วงหน้า  
Remarks : Excluded VAT 7%. The Company reserves the right to change the prices without announcement.



# “EMAUX” P50 Series Halogen & LED Underwater Lights Built-In Type

**FEATURES**

- Material : Plastic
- Cable 1.5 meters
- Waterproof: IP68
- Installation: Built-in type

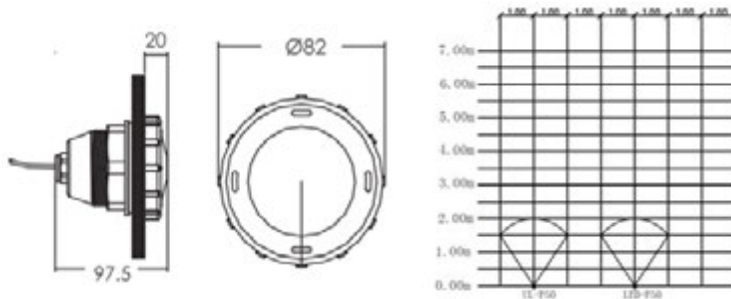

**Cable 1.5 Meter / Waterproof Standard: IP68**

Code	Model	Material	Bulb Type	W/V	LUX	Colour	Retail Price	Code✘
21100510300	UL-P50	Plastic	Halogen	20W/12V	700	White	1,200.00	H★

**Cable 1.5 Meter / Waterproof Standard: IP68**

Code	Model	Material	Bulb Type	W/V	LUX	Colour	Retail Price	Code✘
21100510305	LED-P50-CW	Plastic	MR16 – 18	1W/12V	70	Cool white	1,900.00	H★
21100510310	LED-P50-RGB		Bulbs LED Panel		120	Auto Colour Change	1,900.00	

**Light Bulb Spare Parts**

KEY NO.	POOLSPA CODES	PART NO.	DESCRIPTIONS	PIECE (S) REQUIRED	RETAIL PRICE 2023
4	21110511020	04011001	Halogen lamp MR16 AC 12V/20W for UL-P50	1	140.00
4	21110511025	04011016	LED-P50 lamp 12V/1W (Automatic Colour-Changing)	1	790.00
4	21110511030	04011015	LED-P50 lamp 12V/1W (White Colour Only)	1	790.00

หมายเหตุ : ราคายังไม่รวมภาษี 7% บริษัทฯ ขอสงวนสิทธิ์ในการเปลี่ยนแปลงราคาโดยไม่ต้องแจ้งให้ทราบล่วงหน้า  
Remarks : Excluded VAT 7%. The Company reserves the right to change the prices without announcement.



# “EMAUX” F20 Series For Fountain Pool Halogen & LED Underwater Lights Built-In & Stand Type

**Features**

- Material : AISI Stainless steel 304
- Cable 2.5 meters
- Waterproof: IP68
- Installation: Floor Mounted with Housing type

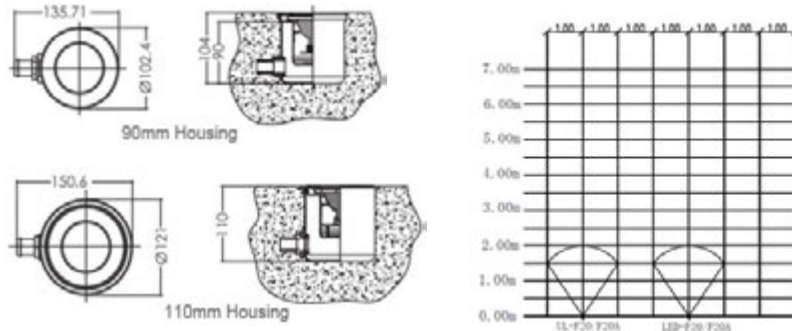

**Cable 2.5 Meter / Waterproof Standard: IP68**

Code	Model	Material	Bulb Type	W/V	LUX	Colour	Retail Price	Code✘
21100510315	UL-F20	S.S.304	Halogen	20W/12V	1039	White	6,100.00	H★

**Cable 2.5 Meter / Waterproof Standard: IP68**

Code	Model	Material	Bulb Type	W/V	LUX	Colour	Retail Price	Code✘
21100510320	LED-F20-CW	S.S.304	MR16 – 18	1W/12V	80	Cool white	7,300.00	H★
21100510325	LED-F20- RGB		Panel		130	Auto Colour Change	7,300.00	

**Light Bulb Spare Parts**

KEY NO.	POOLSPA CODES	PART NO.	DESCRIPTIONS	PIECE (S) REQUIRED	RETAIL PRICE 2023
6	21110511020	04011001	MR16 Halogen Lamp 12V/20W	1	150.00
6	21110511025	04011016	MR16 (18 Bulbs) LED 12V/1W Panel (Automatic Colour Change)	1	790.00
6	21110511030	04011015	MR16 (18 Bulbs) LED 12V/1W Panel (White-Colour)	1	790.00

หมายเหตุ : ราคายังไม่รวมภาษี 7% บริษัทฯ ขอสงวนสิทธิ์ในการเปลี่ยนแปลงราคาโดยไม่ต้องแจ้งให้ทราบล่วงหน้า  
Remarks : Excluded VAT 7%. The Company reserves the right to change the prices without announcement.



# “EMAUX” F20A Series For Fountain Pool Halogen & LED Underwater Lights Built-In & Stand Type

**Features**

- Material : AISI Stainless steel 304
- Cable 2.5 meters
- Waterproof: IP68
- Installation: Floor Mounted with Housing type

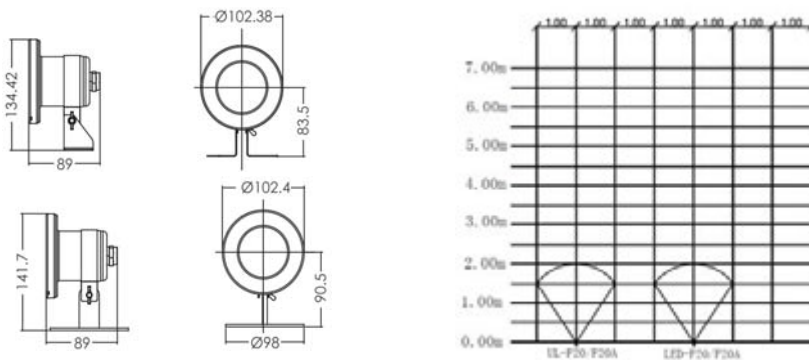

**Cable 2.5 Meter / Waterproof Standard: IP68**

Code	Model	Material	Bulb Type	W/V	LUX	Colour	Retail Price	Code✕
21100510330	UL-F20A	S.S.304 with stand	Halogen	20W/12V	1039	White	3,900.00	H★

**Cable 2.5 Meter / Waterproof Standard: IP68**

Code	Model	Material	Bulb Type	W/V	LUX	Colour	Retail Price	Code✕
21100510335	LED-F20A-CW	S.S.304 with stand	MR16 – 18 Bulbs LED Panel	1W/12V	80	Cool white	5,100.00	H★
21100510340	LED-F20A-RGB				130	Auto Colour Change	5,100.00	

**Light Bulb Spare Parts**

KEY NO.	POOLSPA CODES	PART NO.	DESCRIPTIONS	PIECE (S) REQUIRED	RETAIL PRICE 2023
6	21110511020	04011001	MR16 Halogen Lamp 12V/20W	1	150.00
6	21110511025	04011016	MR16 (18 Bulbs) LED 12V/1W Panel (Automatic Colour Change)	1	790.00
6	21110511030	04011015	MR16 (18 Bulbs) LED 12V/1W Panel (White-Colour)	1	790.00

หมายเหตุ : ราคายังไม่รวมภาษี 7% บริษัทฯ ขอสงวนสิทธิ์ในการเปลี่ยนแปลงราคาโดยไม่ต้องแจ้งให้ทราบล่วงหน้า  
Remarks : Excluded VAT 7%. The Company reserves the right to change the prices without announcement.



# “EMAUX” ColourTouch Series Light Control System for E-LumenX Series

### COLORTOUCH LIGHT CONTROL BOX WITH REMOTE CONTROLLER

By using the simple two-core wires and 12~32Vac operation system, ColorTouch system becomes an ideal choice for most of the pool retrofit and refurbishment projects. One-touch 7 individual colors, auto-color changing, and 3-level brightness dimmer selections by using the remote-controller which features compact, user-friendly design and water resistant. 50m wireless remote-control distance in open area.



### FEATURES

- By using the simple two-core wires and 12~32Vac operation system, ColorTouch system becomes an ideal choice for most of the pool retrofit and refurbishment projects.
- One-touch 7 individual colors, auto-color changing, and 3-level brightness dimmer selections by using the remote-controller which features compact, user-friendly design and water resistant.
- 50m wireless remote-control distance in open area.

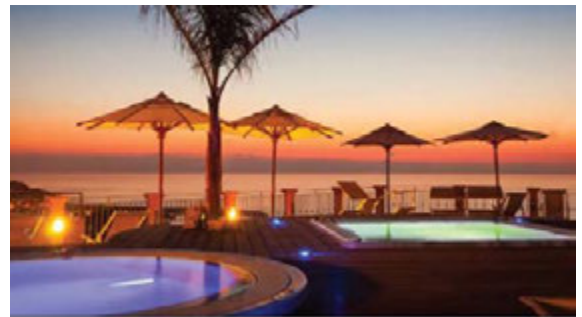

ColorTouch System controls color changes of two pools at the same time

### TWO ZONES SYNCHRONIZED COLOR CONTROL

- ColorTouch control system can control different mode of lighting in two zones at the same time.
- Each zone can support pool light fixtures with maximum voltage of 300VA.
- Simply one-touch reset button is available to bring two zones into line instantly.

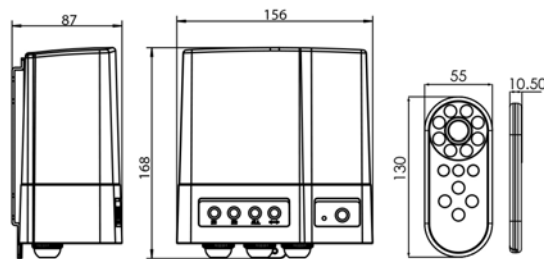
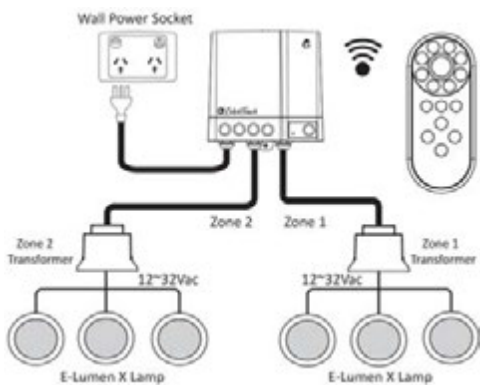

Code	Model	Description	Retail Price	Code✕
21120510055	ColourTouch	Control Box with Remote Control For RGB Lights only – 600W Suitable with “E-Lumen-X” Light Only	14,400.00	H★

หมายเหตุ : ราคายังไม่รวมภาษี 7% บริษัทฯ ขอสงวนสิทธิ์ในการเปลี่ยนแปลงราคาโดยไม่ต้องแจ้งให้ทราบล่วงหน้า  
Remarks : Excluded VAT 7%. The Company reserves the right to change the prices without announcement.



# “EMAUX” RGB-CB Series Remote & Control Box For E-Lumen Series

Remote Control for RGB Lights  
Electrical overload and leakage protection

### FEATURES

- IP 44 rating, suitable for outdoor use
- Maximum load of 600W with power indicator
- Made from fire-proof ABS material
- Electrical overload & leakage protection
- Two control modes-manual and timer mode in which the ON/PFF time of load can be set
- The hand-d/held remote control interacts with the control box from a distance
- Simple and easy operation with 4 keys:
- 10 effects are sequenced numbered, RESET key set all lights to the first effect
- POOL and SPA Key are used to change effect of lights connected to Pool line and Spa line respectively

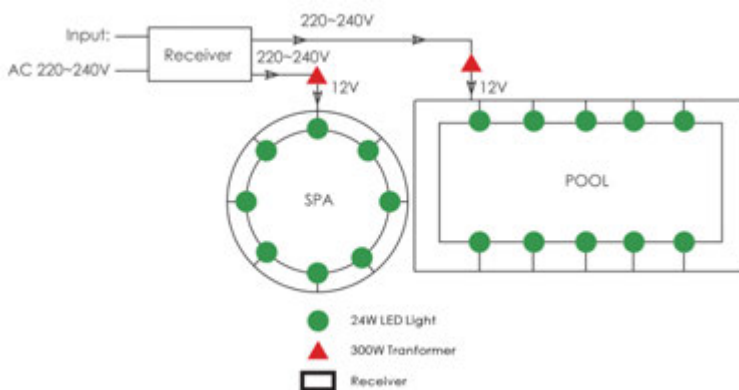

Code	Model	Description	Retail Price	Code✘
21120510010	RGB-CB	Control Box with Remote Control / For RGB Lights only – 600W	10,700.00	H★

หมายเหตุ : ราคายังไม่รวมภาษี 7% บริษัทฯ ขอสงวนสิทธิ์ในการเปลี่ยนแปลงราคาโดยไม่ต้องแจ้งให้ทราบล่วงหน้า  
Remarks : Excluded VAT 7%. The Company reserves the right to change the prices without announcement.



## Junction Boxes



Code	Model	Brand	Description	Retail Price	Code✘
21121610005	PSJB-01	POOLSPA	Adjustable ABS Junction Box, with Stainless Steel Covered	580.00	B★



Code	Model	Brand	Description	Retail Price	Code✘
21120510035	EM2823	EMAUX	Plastic ABS	360.00	B★



Code	Model	Brand	Description	Retail Price	Code✘
21120510040	EM2823C	EMAUX	Plastic ABS Complete set with 1 meter hose and adaptors	570.00	B★



## Transformers



Code	Model	Description	Retail Price	Code✘
21123000030	TF-3	3W / 12V	550.00	B★
21123000035	TF-10	10W / 12V	590.00	
21123000005	TF-20	20W / 12V	650.00	
21123000010	TF-50	50W / 12V	750.00	
21123000015	TF-100	100W / 12V	1,250.00	
21123000020	TF-150	150W / 12V	1,550.00	
21123000025	TF-300	300W / 12V	2,350.00	

หมายเหตุ : ราคายังไม่รวมภาษี 7% บริษัทฯ ขอสงวนสิทธิ์ในการเปลี่ยนแปลงราคาโดยไม่ต้องแจ้งให้ทราบล่วงหน้า  
 Remarks : Excluded VAT 7%. The Company reserves the right to change the prices without announcement.



# “EMAUX” Glow+ Underwater LED Strip LED Underwater Lights

### AESTHETIC UNDERWATER LIGHTING EFFECT

Glow+ is an extendable and top view flexible LED strip for creating underwater profile lighting. The flexible linear design fits to any shapes or sizes of pools that have straight or curved profiles. Its completely waterproof feature enables it to be widely used in swimming pool, spa, and water features.

### FEATURES

- Lengths of up to 20m minimize the number of required connections.
- Its waterproof, UV, saltwater, flame, solvents and dirt resistant characteristics provide a long, maintenance-free life.
- Waterproof accessories allow safe and easy installation and connection.
- Certificated LM-80 and ANSI C78.377 LED lighting standards and IK08 for external impact resistance.
- Available in range of white CCT intensity from 2700K-6500K for ambient matching.
- 120-degree beam angle. Flat rectangular diffuser surface provides a smooth profile.
- Manual or Wireless remote dimmer is available for adjusting lighting effects.



Code	Model	Description	Retail Price	Code✖
21100510545	GL10 ✖	White LED Strip	2,900.00	B
Code	Model	Description	Retail Price	Code✖
21120510065	GL10SR ✖	Power Connector, Side Right, For 0.5-10m.	900.00	B
21120510070	GL10SL ✖	Power Connector, Side Left, For 0.5-10m.	900.00	
21120510075	GL10LR ✖	Power Connector, Side Both, For 10.5-20m.	1,200.00	
21120510080	GL10SD ✖	Power Connector, Side Direct, For 0.5-10m.	900.00	
21120510085	GL10BD ✖	Power Connector, Side Direct, For 10.5-20m.	1,200.00	
21120510090	GL10SB ✖	Power Connector, Side Bottom, For 0.5-10m.	900.00	
21120510095	GL10BB ✖	Power Connector, Side Bottom, For 10.5-20m	1,200.00	
21120510100	Dimmer Controller ✖	LED Dimmer Controller with Remote	2,900.00	
21120510105	HLG-240H-24 ✖	Power Supply 240W/24V, 100-240V, AC50/60pHz Input Voltage	9,900.00	
21120510110	HLG-120H-24 ✖	Power Supply 120W/24V, 100-120V, AC50/60pHz input voltage	6,900.00	
21120510115	GLPMC ✖	Plastic Mounting Clips Transparent 35mm.	150.00	
21120510120	GLPMC1M ✖	Plastic Mounting Channel Transparent 1m.	600.00	
21120510125	GLSMC ✖	Stainless Steel Mounting Clips 5cm.	300.00	
21120510130	GLDIYSC ✖	DIY End Connector Kit	500.00	

✖ สินค้าไม่มีสต็อก กรุณาสั่งล่วงหน้า 60-90 วัน / No Stock, Delivery Time 60-90 Days

หมายเหตุ : ราคายังไม่รวมภาษี 7% บริษัท ขอสงวนสิทธิ์ในการเปลี่ยนแปลงราคาโดยไม่ต้องแจ้งให้ทราบล่วงหน้า  
Remarks : Excluded VAT 7%. The Company reserves the right to change the prices without announcement.



# COMPETITION EQUIPMENTS







## Float Line Roller

Code	Model	Description	Retail Price	Code✘
21301610055	PSC-01 ✘	Float Line Roller for 50 meters ที่ม้วนเก็บลู่ตัดคลื่น วัสดุสแตนเลส สำหรับ 50 เมตร	55,000.00	B
21301610060	PSC-02 ✘	Float Line Roller for 100 meters ที่ม้วนเก็บลู่ตัดคลื่น วัสดุสแตนเลส สำหรับ 100 เมตร	69,000.00	
21301610065	PSC-03 ✘	Float Line Roller for 150 meters ที่ม้วนเก็บลู่ตัดคลื่น วัสดุสแตนเลส สำหรับ 150 เมตร	76,000.00	

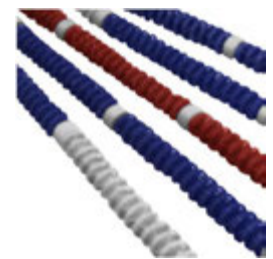

## Float Line

Code	Model	Description	Retail Price	Code✘
21301610045	PSC-04 ✘	Float Line 25 meters ลู่ตัดคลื่นยาว 25 เมตร	22,900.00	B
21301610050	PSC-05 ✘	Float Line 50 meters ลู่ตัดคลื่นยาว 50 เมตร	36,900.00	

## Stainless Steel Float Line Ratchet Tensioner



Code	Model	Description	Retail Price	Code✘
21301610005	PSC-06 ✘	Stainless Steel Float Line Ratchet Tensioner ชุดแรงลู่ วัสดุสแตนเลส	11,000.00	B

✘ สินค้าไม่มีสต็อก กรุณาสั่งซื้อล่วงหน้า / No Stock, Delivery Time : 30 - 60 Days

หมายเหตุ : ราคายังไม่รวมภาษี 7% บริษัทฯ ขอสงวนสิทธิ์ในการเปลี่ยนแปลงราคาโดยไม่ต้องแจ้งให้ทราบล่วงหน้า  
Remarks : Excluded VAT 7%. The Company reserves the right to change the prices without announcement.



## Stainless Steel Concrete Cup Anchor



Code	Model	Description	Retail Price	Code✘
21301610010	PSC-07✘	Stainless Steel Concrete Cup Anchor ถ้วยยึดลู่ วัสดุสแตนเลส	2,600.00	B

## Life Guard Hook & Bouynce



Code	Model	Description	Retail Price	Code✘
21301610015	PSC-08✘	Life Guard Hook with Telescopic Pole 9 ft ตะขอช่วยชีวิต วัสดุสแตนเลส พร้อมด้ามยาว 9 ฟุต	6,900.00	B
21301610020	PSC-09✘	Life Bouynce ห่วงชูชีพพลาสติก	2,600.00	

## Backstroke Turn Indicators



Code	Model	Description	Retail Price	Code✘
21301610025	PSC-10✘	Backstroke Turn Indicators เสาธงแข่งขัน วัสดุสแตนเลส พร้อมธงติดเชือก	19,000.00	B

✘ สินค้าไม่มีสต็อก กรุณาสั่งซื้อล่วงหน้า / No Stock, Delivery Time : 30 - 60 Days

หมายเหตุ : ราคายังไม่รวมภาษี 7% บริษัทฯ ขอสงวนสิทธิ์ในการเปลี่ยนแปลงราคาโดยไม่ต้องแจ้งให้ทราบล่วงหน้า  
Remarks : Excluded VAT 7%. The Company reserves the right to change the prices without announcement.



### Stainless Steel Guard Chair (Fixed)

Code	Model	Description	Retail Price	Code✖
21301610070	PSC-11 ✖	Stainless Steel Guard Chair (Fixed) เก้าอี้กรรมการ วัสดุสแตนเลส ชนิดฝักระเบียงสระ	55,000.00	B



### Stainless Steel Guard Chair (Movable)

Code	Model	Description	Retail Price	Code✖
21301610075	PSC-12 ✖	Stainless Steel Guard Chair (Movable) เก้าอี้กรรมการ วัสดุสแตนเลส ชนิดเคลื่อนที่ได้	59,000.00	B

### Diving Board

Code	Model	Description	Retail Price	Code✖
21301610085	PSC-17 ✖	Diving Board 12ft with Height at 1 meter กระดานกระโดด วัสดุสแตนเลส FINA STANDARD สูง 1 เมตร	269,000.00	B
21301610080	PSC-13 ✖	Diving Board Height at 3 meters กระดานกระโดด วัสดุสแตนเลส FINA STANDARD สูง 3 เมตร	389,000.00	

✖ สินค้าไม่มีสต็อก กรุณาสั่งซื้อล่วงหน้า / No Stock, Delivery Time : 30 - 60 Days

หมายเหตุ : ราคายังไม่รวมภาษี 7% บริษัทฯ ขอสงวนสิทธิ์ในการเปลี่ยนแปลงราคาโดยไม่ต้องแจ้งให้ทราบล่วงหน้า  
Remarks : Excluded VAT 7%. The Company reserves the right to change the prices without announcement.



## Starting Platform

Code	Model	Description	Retail Price	Code✖
21301610040	PSC-14✖	Starting Platform แท่นสตาร์ท วัสดุสแตนเลส ชนิดถอดเก็บได้	69,000.00	B



## Turning Panels

Code	Model	Description	Size	Retail Price	Code✖
21301610030	PSC-15✖	Turning Panels เป็นกลีบตัว	0.30 x 1.60 meters	42,000.00	B
21301610090	PSC-18✖		0.30 x 2.37 meters	49,000.00	



## Underwater Window

Code	Model	Description	Retail Price	Code✖
21301610035	PSC-16✖	Underwater Window กระจกใต้น้ำ ขนาด 1.20 X 0.60 เมตร	79,000.00	B

✖ สินค้าไม่มีสต็อก กรุณาสั่งซื้อล่วงหน้า / No Stock, Delivery Time : 30 - 60 Days

หมายเหตุ : ราคายังไม่รวมภาษี 7% บริษัทฯ ขอสงวนสิทธิ์ในการเปลี่ยนแปลงราคาโดยไม่ต้องแจ้งให้ทราบล่วงหน้า  
Remarks : Excluded VAT 7%. The Company reserves the right to change the prices without announcement.





# **WATER FEATURES**





# “EMAUX” Water Descents

**MAKE YOUR POOL ALIVE!**

**FEATURES**

- Available in two different widths: 25mm & 150mm, they are suitable for different wall sizes.
- Four different lengths: 300mm, 600mm, 900mm & 1200mm.
- LED strip is powered by external 12V DC, which is safe and reliable
- The LEDs can be operated through panel or remote control and 10 lighting patterns are available.
- Multiple water descents can share the same controller for synchronized colour effects



**Optional Control & Remote**  
Model WTD-CB



Suggested Pump						
Model	1 m Head with			5 m Head with		
	160 mm	220 mm	260 mm	160 mm	220 mm	260 mm
<b>PB300</b>	N / A	N / A	N / A	AMU016	AMU020	AMU020
<b>PB600</b>	N / A	N / A	N / A	AMU016	SS033	SS033
<b>PB900</b>	N / A	AMU012	AMU016	AMU020	SS050	SS050
<b>PB1200</b>	AMU012	AMU016	AMU020	AMU020	SS050	SS075

Water Descent Set up at 900 mm Height			
Model	23Lpm with	34Lpm with	45Lpm with
	160 mm distance	220 mm distance	260 mm distance
	Flow per hour (m3)	Flow per hour (m3)	Flow per hour (m3)
<b>PB300</b>	1.38	2.04	2.7
<b>PB600</b>	2.76	4.08	5.4
<b>PB900</b>	4.14	6.12	8.1
<b>PB1200</b>	5.52	8.16	10.8

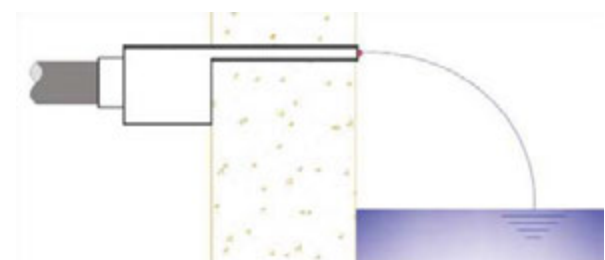
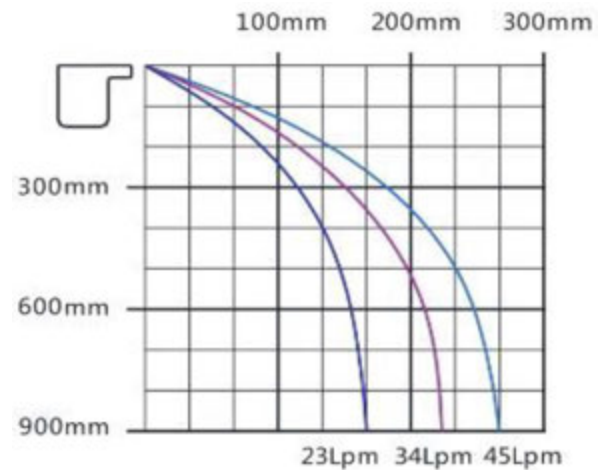



Product Information and Dimensions

Code (LED)	Model (LED)	Code	Model	A(mm)	B(mm)	C(mm)	D(mm)	Remark
88480101	PB300-25(L)	88485001	PB300-25	306	138	76	25	12V DC 4W
88480102	PB300-150(L)	88485002	PB300-150		263		150	
88480111	PB600-25(L)	88485011	PB600-25	606	138	76	25	12V DC 8W
88480112	PB600-150(L)	88485012	PB600-150		263		150	
88480121	PB900-25(L)	88485021	PB900-25	906	138	76	25	12V DC 12W
88480122	PB900-150(L)	88485022	PB900-150		263		150	
88480131	PB1200-25(L)	88485031	PB1200-25	1206	138	76	25	12V DC 17W
88480132	PB1200-150(L)	88485032	PB1200-150		263		150	

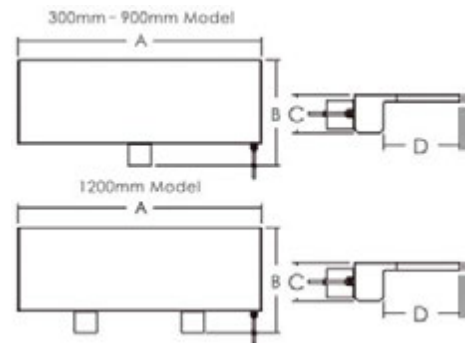

Code	Model	Descriptions	Connection Size		Dimension (mm)				With LED	Retail Prices	Code✳		
					L	W	H	A					
21500510005	PB300-25	Water Descent	1.5	inch	50	mm	306	138	76	25		5,600.00	H★
21510510005	PB300-25 (L)	300-25									4W/12V	9,700.00	
21500510010	PB300-150	Water Descent	1.5	inch	50	mm	306	263	76	150		9,300.00	
21510510010	PB300-150 (L)	300-150									4W/12V	12,900.00	
21500510020	PB600-25	Water Descent	1.5	inch	50	mm	606	138	76	25		9,600.00	
21510510020	PB600-25 (L)	600-25									8W/12V	16,000.00	
21500510025	PB600-150	Water Descent	1.5	inch	50	mm	606	263	76	150		17,000.00	
21510510025	PB600-150 (L)	600-150									8W/12V	23,000.00	
21500510035	PB900-25	Water Descent	1.5	inch	50	mm	906	138	76	25		13,900.00	
21510510035	PB900-25 (L)	900-25									12W/12V	21,500.00	
21500510040	PB900-150	Water Descent	1.5	inch	50	mm	906	263	76	150		23,000.00	
21510510040	PB900-150 (L)	900-150									12W/12V	29,000.00	
21500510050	PB1200-25	Water Descent	1.5	inch	50	mm	1206	138	76	25		15,900.00	
21510510050	PB1200-25 (L)	1200-25									16W/12V	23,000.00	
21500510055	PB1200-150	Water Descent	1.5	inch	50	mm	1206	263	76	150		24,600.00	
21510510055	PB1200-150 (L)	1200-150									16W/12V	30,700.00	
21530510005	WTD-CB	LED Water Descent Control Box	Input 170-250V/50-60HZ & Output 12V/60Hz can control up to 60W of LED light									11,900.00	

✳✳ ราคาไม่รวมปั๊ม / Excluded pump.

✳✳✳ รุ่นที่มี LED ต้องซื้อ KZD60 เพื่อควบคุมการเปลี่ยนสี / For LED Model must buy KZD60 to control the colour

หมายเหตุ : ราคายังไม่รวมภาษี 7% บริษัทฯ ขอสงวนสิทธิ์ในการเปลี่ยนแปลงราคาโดยไม่ต้องแจ้งให้ทราบล่วงหน้า  
Remarks : Excluded VAT 7%. The Company reserves the right to change the prices without announcement.



# “EMAUX” Shower Heads

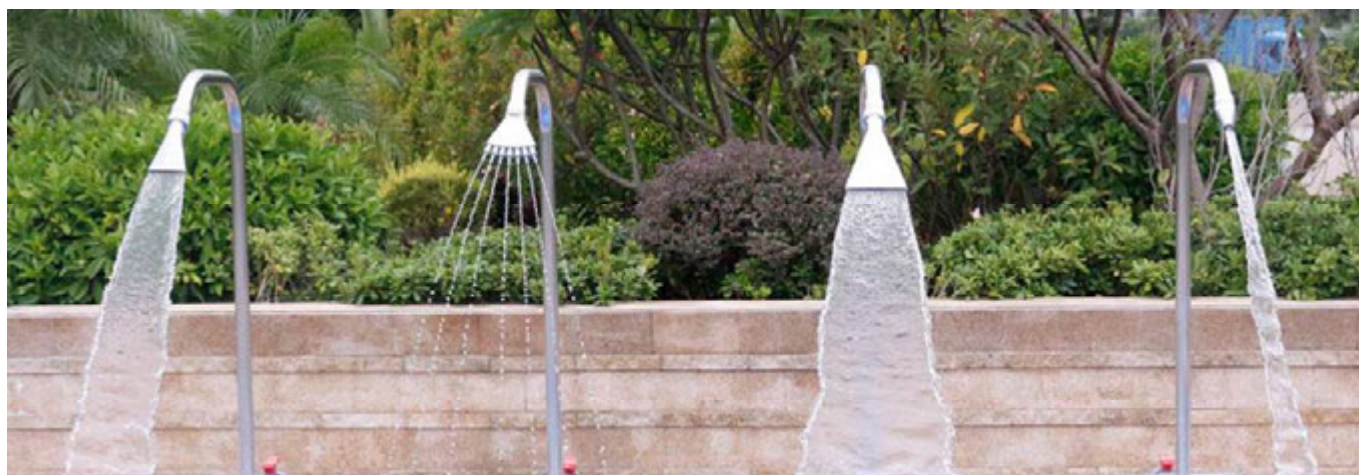

**FAST SPRAY**  
**EM4401**

**SOFT SPRAY**  
**EM4407**

**FULL BODY SPRAY**  
**EM4402**

**JET MASSAGE**  
**EM4405**

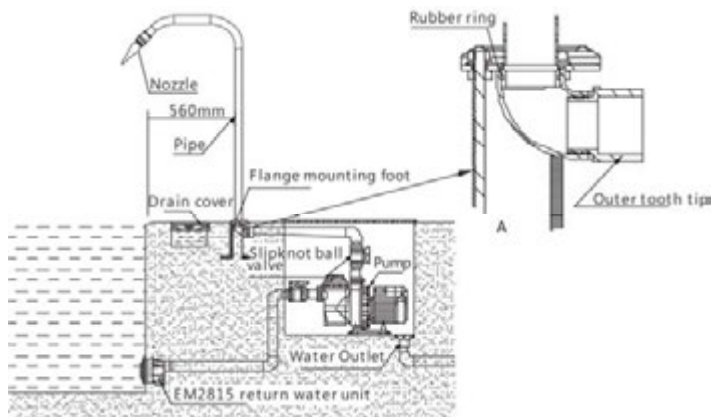
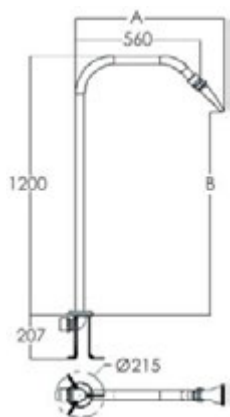

Model No.	Product Name	Connection Dimensions	Pressure (Kpa)	Flow Rate (m <sup>3</sup> /h)	Pattern	Min Pump Head	A mm	B mm
EM4401	Fast Spray	1.5" / 50mm	20 - 100	14.0 - 48.4	Universal Type	2m	663	946
EM4402	Full Body Spray	1.5" / 50mm	20 - 100	14.0 - 48.4	Universal Type	2m	705	902
EM4403	Intense Jet Spray	1.5" / 50mm	20 - 250	5.8 - 24.0	Universal Type	2m	630	962
EM4404	Jet Spray	1.5" / 50mm	20 - 120	18.0 - 50.0	Fixed Type	2m	628	968
EM4405	Jet Massage	1.5" / 50mm	20 - 100	14.0 - 48.4	Fixed Type	2m	553	1016
EM4406	Soft Spray	1.5" / 50mm	20 - 60	5.7 - 12.0	Fixed Type	2m	598	986
EM4407	Massage Spray	1.5" / 50mm	20 - 80	0.6 - 1.1	Universal Type	2m	655	958



**MASSAGE SPRAY**  
EM4406



**JET SPRAY**  
EM4404



**INTENSE JET SPRAY**  
EM4403



**EXPERIENCE WATER IN DIFFERENT WAYS!**

Enjoy hydrotherapy shower using all physical properties of water create new experience. Emaux shower head is designed to offer right solution for user looking for user-friendly and excellent showering massage experience. Emaux shower head has 7 water patterns which can suit your need in a wide range of options.

**FEATURES**

- Stainless Steel AISI 34
- Chrome plating
- Hydrotherapy shower head
- Simple design for wide range of application
- Unique design with excellent water proofing and corrosion proofing
- Easy installation and maintenance

Code	Model	Type	Flowrate (m3/h)	Pressure (Kpa)	Min Pump Head	Connection	Retail Price	Code✖
21200510005	EM4401	Fast Spray	14.0 – 48.4	20 - 100	2 m	1.5" / 50 mm	9,500.00	H★
21200510010	EM4402	Full Body Spray					12,000.00	
21200510015	EM4403	Intense Jet Spray	5.8 – 24.0	20 – 250			8,500.00	
21200510020	EM4404	Jet Spray	18.0 – 50.0	20 – 120			9,500.00	
21200510025	EM4405	Jet Massage	14.0 – 48.4	20 – 100			8,000.00	
21200510030	EM4406	Soft Spray	5.7 – 12.0	20 – 60			9,500.00	
21200510035	EM4407	Massage Spray	0.6 – 1.1	20 - 80			11,000.00	

หมายเหตุ : ราคายังไม่รวมภาษี 7% บริษัทฯ ขอสงวนสิทธิ์ในการเปลี่ยนแปลงราคาโดยไม่ต้องแจ้งให้ทราบล่วงหน้า  
Remarks : Excluded VAT 7%. The Company reserves the right to change the prices without announcement.



# Air Loungers

Air Loungers are suitable for installation in large pools as well as small private pools.

The Air Loungers are made of Stainless Steel 304

### Specifications

- Air Connection : DN 50
- Air Flow Rate : 60 m3/h
- Operation Pressure : 150 mbar
- Max. Perm. Pressure : 250 mbar

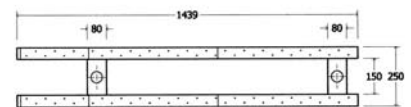
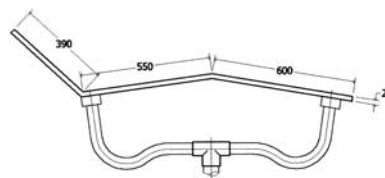
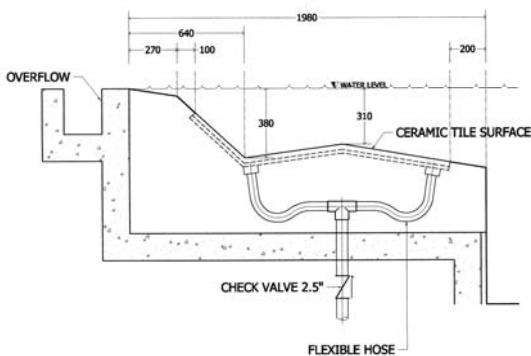

Code	Model	Description	Air Flow (m <sup>3</sup> /hr)	Pipe Connection Size(Inches)	Width (mm)	Length (mm)	Recommend Pump (Distance no more than 5 m)	Retail Price	Code✖
21201610045	PSW-11 ✖	Air Lounger	220	2	250	1439	Air Blower 3HP x 1 set	39,000.00	A

✖✖ ราคาไม่รวมปั๊ม / Excluded pump

✖ สินค้าไม่มีสต็อก กรุณาสั่งซื้อล่วงหน้า / No Stock, Delivery Time : 30 - 60 Days

หมายเหตุ : ราคายังไม่รวมภาษี 7% บริษัทฯ ขอสงวนสิทธิ์ในการเปลี่ยนแปลงราคาโดยไม่ต้องแจ้งให้ทราบล่วงหน้า  
Remarks : Excluded VAT 7%. The Company reserves the right to change the prices without announcement.



# Air Pad

Air Pads are suitable for installation in large pools as well as small private pools.

The Air Pads are made of Stainless Steel 304

<b>Air Connection</b>	DN 32
<b>Operation Pressure(mbar)</b>	150
<b>Max. Perm Pressure(mbar)</b>	250

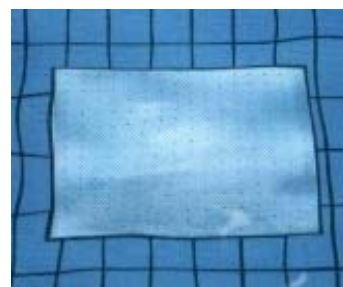

Code	Model	Description	Air Flow (m <sup>3</sup> /hr)	Dimensions	Recommend Pump (Distance no more than 5 m)	Retail Price	Code✕
21201610025	PSW-07✕	Air Pad Water Depth at 90 cm	220	30 x 30 cm	Air Blower 3HP x 1 set	35,000.00	A
21201610030	PSW-08✕		318	50 x 50 cm	Air Blower 5HP x 1 set	42,000.00	
21201610035	PSW-09✕		530	75 x 75 cm	Air Blower 7.5HP x 1 set	52,000.00	
21201610040	PSW-10✕		620	100 x 100 cm	Air Blower 10HP x 1 set	72,000.00	

✕✕ ราคาไม่รวมปั๊ม / Excluded pump

✕ สินค้าไม่มีสต็อก กรุณาสั่งซื้อล่วงหน้า / No Stock, Delivery Time : 30 - 60 Days

หมายเหตุ : ราคายังไม่รวมภาษี 7% บริษัทฯ ขอสงวนสิทธิ์ในการเปลี่ยนแปลงราคาโดยไม่ต้องแจ้งให้ทราบล่วงหน้า  
Remarks : Excluded VAT 7%. The Company reserves the right to change the prices without announcement.



# Water Hedgehog

Water Hedgehog is one of the most popular water features for both kids and adults. It is suitable for installation in large pools as well as small private pools.

The water hedgehog are made of Fiberglass.

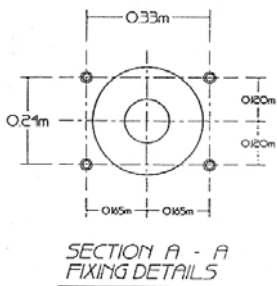
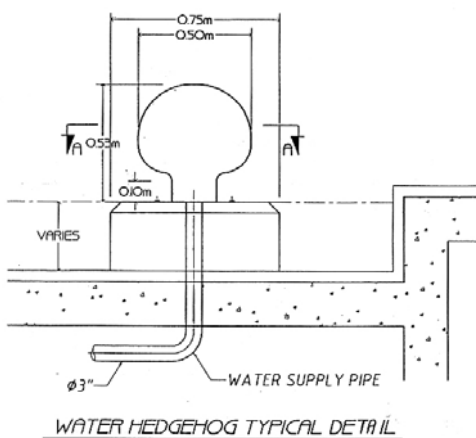

Model	Size (mm)	Pipe	Flow Rate (m <sup>3</sup> /h)
PSW-01	L650 x W450 x H500	3"	24

Code	Model	Description	Air Flow (m <sup>3</sup> /hr)	Recommend Pump (Distance no more than 5 m)	Retail Price	Code✘
21201610005	PSW-01 ✘	Water Hedgehog	120	"EMAUX" SR300 x 1 set	22,000.00	A ★

✘✘ ราคาไม่รวมปั๊ม / Excluded pump

✘ สินค้าไม่มีสต็อก กรุณาสั่งซื้อล่วงหน้า / No Stock, Delivery Time : 30 - 60 Days

หมายเหตุ : ราคายังไม่รวมภาษี 7% บริษัทฯ ขอสงวนสิทธิ์ในการเปลี่ยนแปลงราคาโดยไม่ต้องแจ้งให้ทราบล่วงหน้า  
Remarks : Excluded VAT 7%. The Company reserves the right to change the prices without announcement.



# Water Curtain

**MATERIAL**

- Stainless steel 304

Model	Compressed Air Connection	Flow Rate (m <sup>3</sup> /h)	Operation Pressure (bar)	Max. Perm Pressure (mbar)
PSW-05	DN 100	60-96	0.4-0.6	0.8



Code	Model	Description	Flow Rate (gpm)	Pipe Connection Size (Inches)	Width of the mouth (mm)	Height (mm)	Recommend Pump (Distance no more than 5 m)	Retail Price	Code✘
21200510040	PSW-05✘	Water Curtain	180	3	800	950	"EMAUX" SPH400 x 1 set	84,000.00	A

✘✘ ราคาไม่รวมปั๊ม / Excluded pump



**MATERIAL**

- Stainless steel 316

Code	Model	Description	Flow Rate (gpm)	Pipe Connection Size (Inches)	Width of the mouth (mm)	Height (mm)	Recommend Pump (Distance no more than 5 m)	Retail Price	Code✘
21201610105	PSW-22✘	Water Curtain	62	1.5	500	460	"EMAUX" SPH100 x 1 set	29,000.00	A

✘✘ ราคาไม่รวมปั๊ม / Excluded pump

✘ สินค้าไม่มีสต็อก กรุณาสั่งซื้อล่วงหน้า / No Stock, Delivery Time : 30 - 60 Days

หมายเหตุ : ราคายังไม่รวมภาษี 7% บริษัทฯ ขอสงวนสิทธิ์ในการเปลี่ยนแปลงราคาโดยไม่ต้องแจ้งให้ทราบล่วงหน้า  
Remarks : Excluded VAT 7%. The Company reserves the right to change the prices without announcement.





# Water Umbrella Water Feature

Water Umbrella is one of the most popular water features for both kids and adults. It is suitable for installation in large pools as well as small private pools. The water umbrella are made of Fiberglass

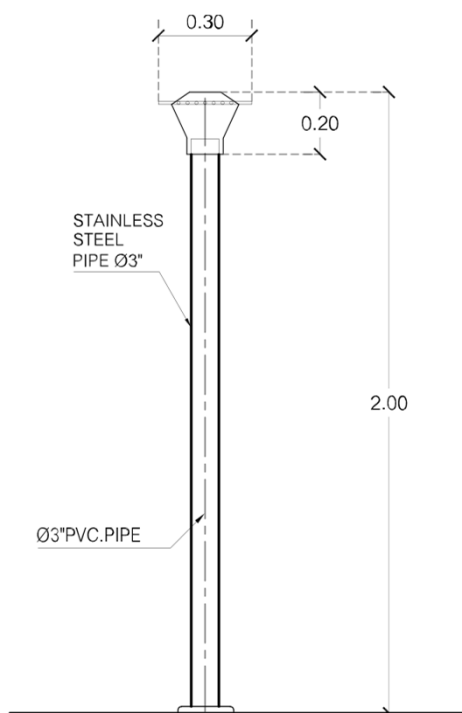

Model	Compressed Air Connection	Flow Rate (m <sup>3</sup> )	Operation Pressure (bar)	Max. Perm Pressure (mbar)
PSW-06	DN 100	60 - 96	0.4 – 0.6	0.8

Code	Model	Description	Flow Rate (gpm)	Pipe Connection Size (Inches)	Width (mm)	Height (mm)	Recommend Pump (Distance no more than 5 m)	Retail Price	Code✘
21200510045	PSW-06 ✘	Water Umbrella	180	3	200	2500	“EMAUX” SPH400 x 1 set	65,000.00	A

✘✘ ราคาไม่รวมปั๊ม / Excluded pump

✘ สินค้าไม่มีสต็อก กรุณาลงสั่งซื้อล่วงหน้า / No Stock, Delivery Time : 30 - 60 Days

หมายเหตุ : ราคายังไม่รวมภาษี 7% บริษัทฯ ขอสงวนสิทธิ์ในการเปลี่ยนแปลงราคาโดยไม่ต้องแจ้งให้ทราบล่วงหน้า  
Remarks : Excluded VAT 7%. The Company reserves the right to change the prices without announcement.



# Water Ring



Model	A (m)	B (m)
PSW-18	0.95	1.90
PSW-12	1.80	1.40

Code	Model	Description	Flow Rate (gpm)	Pipe Connection Size (Inches)	Recommend Pump (Distance no more than 5 m)	Retail Price	Code✘
21201610085	PSW-18	Water	2	78	“EMAUX” SS150 x 1 set	21,000.00	A
21201610050	PSW-12	Ring✘	2	78	“EMAUX” SS150 x 1 set	21,000.00	

✘✘ ราคาไม่รวมปั๊ม / Excluded pump



# Rain Curtain



Model	Flow Rate (gpm)	Pipe Connection Size (Inch)	Nozzles	Recommend Pump (Distance no more than 5 m)
PSW-13	65	2	Size 3mm Qty 40 sets	“EMAUX” SB10 x 1 set

Code	Model	Description	Length (m)	Width (m)	Height (m)	Retail Price	Code✘
21201610055	PSW-13✘	Rain Curtain (Stainless Steel 304 Structure with Fiberglass finishing)	2.50	0.30	2.00	159,000.00	A

✘✘ ราคาไม่รวมปั๊ม / Excluded pump

✘ สินค้าไม่มีสต็อก กรุณาสั่งซื้อล่วงหน้า / No Stock, Delivery Time : 30 - 60 Days

หมายเหตุ : ราคายังไม่รวมภาษี 7% บริษัทฯ ขอสงวนสิทธิ์ในการเปลี่ยนแปลงราคาโดยไม่ต้องแจ้งให้ทราบล่วงหน้า  
Remarks : Excluded VAT 7%. The Company reserves the right to change the prices without announcement.



# Misting Palm

**MISTING PALM**

- SIZE PIPE Ø2
- Body stainless steel
- Sprayed color

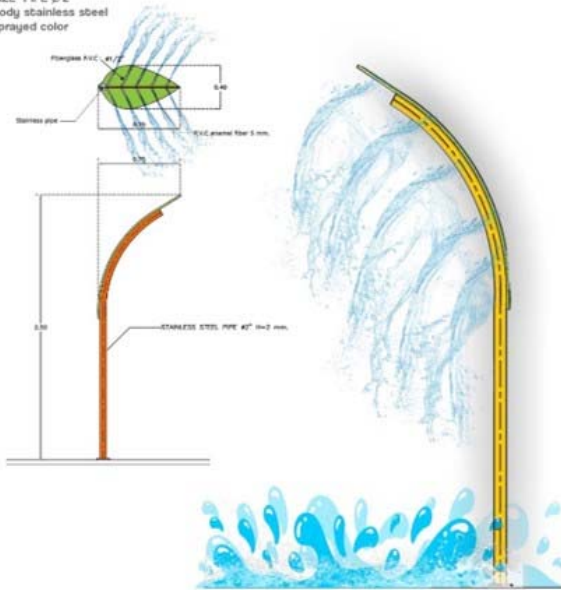

Code	Model	Description	Flow Rate (gpm)	Pipe Connection Size (Inches)	Leaf Size (m)	Leaf Centre Piece (m)	Recommend Pump (Distance no more than 5 m)	Retail Price	Code✖
21201610080	PSW-21 ✖	Misting Palm	30	1.5	0.75m x 0.4m	H 2.50m x W 0.75m	“EMAUX” SC050 x 1 set	32,000.00	A

✖✖ ราคาไม่รวมปั๊ม / Excluded pump

✖ สินค้าไม่มีสต็อก กรุณาลงชื่อล่วงหน้า / No Stock, Delivery Time : 30 - 60 Days

หมายเหตุ : ราคายังไม่รวมภาษี 7% บริษัทฯ ขอสงวนสิทธิ์ในการเปลี่ยนแปลงราคาโดยไม่ต้องแจ้งให้ทราบล่วงหน้า  
Remarks : Excluded VAT 7%. The Company reserves the right to change the prices without announcement.



# Water Mushrooms

Model	A (m)	B (m)	C (m)
PSW-14	0.45	0.45	0.20
PSW-15	0.55	0.50	0.18
PSW-16	0.60	0.55	0.18

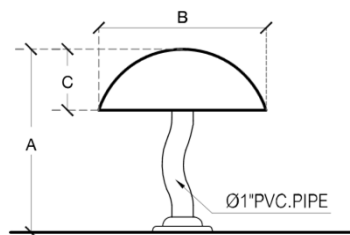

Code	Model	Description	Flow Rate (gpm)	Pipe Connection Size (Inch)	Recommend Pump (Distance no more than 5 m)	Retail Price	Code✘
21201610090	PSW-14 ✘	Water Mushroom	30	1	"EMAUX" SC050 x 1 set	17,000.00	A
21201610095	PSW-15 ✘					19,000.00	
21201610100	PSW-16 ✘					22,000.00	

✘✘ ราคาไม่รวมปั๊ม / Excluded pump

Model	A (m)	B (m)
PSW-02	2.45	1.50
PSW-03	2.51	1.80
PSW-04	2.69	2.30

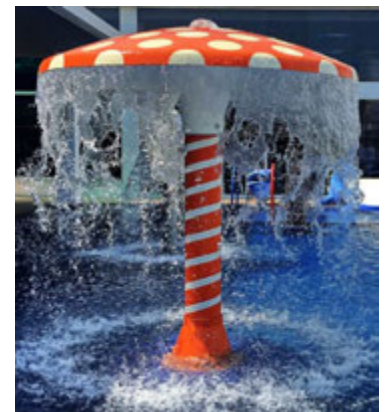
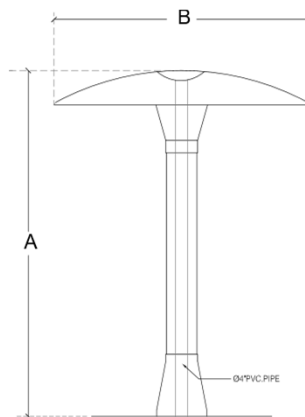

Code	Model	Description	Flow Rate (gpm)	Pipe Connection Size (Inch)	Recommend Pump (Distance no more than 5 m)	Retail Price	Code✘
21201610010	PSW-02 ✘	Water Mushroom	440	4	"SPECK PUMP" BADU RESORT 110 x 1 set	119,000.00	A
21201610015	PSW-03 ✘					149,000.00	
212016100120	PSW-04 ✘					229,000.00	

✘✘ ราคาไม่รวมปั๊ม / Excluded pump

✘ สินค้าไม่มีสต็อก กรุณาสั่งซื้อล่วงหน้า / No Stock, Delivery Time : 30 - 60 Days

หมายเหตุ : ราคายังไม่รวมภาษี 7% บริษัทฯ ขอสงวนสิทธิ์ในการเปลี่ยนแปลงราคาโดยไม่ต้องแจ้งให้ทราบล่วงหน้า  
Remarks : Excluded VAT 7%. The Company reserves the right to change the prices without announcement.



# Fountain Animals



Code	Model	Description	Flow Rate (m3/h)	Dimensions (cm)	Retail Price	Code✘
21201610075	WH200✘	Baby Whale Fountain	4	W 60 x L 140 x H 100	29,000.00	A



WH100



SK115



SH368

## Dolphin Fountain

Code	Model	Description	Flow Rate (m3/h)	Dimensions (cm)	Retail Price	Code✘
21201610060	WH100✘	Dolphin Fountain	4	W 70 x L 160 x H 100	32,000.00	A

## Shark Fountain

Code	Model	Description	Flow Rate (m3/h)	Dimensions (cm)	Retail Price	Code✘
21201610065	SK115✘	Shark Fountain	4	W 78 x L 151 x H 115	39,000.00	A

## Sea Horse Fountain

Code	Model	Description	Flow Rate (m3/h)	Dimensions (cm)	Retail Price	Code✘
21201610070	SH368✘	Sea Horse Fountain	10	W 45 x L 120 x H 368	39,000.00	A

✘ สินค้าไม่มีสต็อก กรุณาสั่งซื้อล่วงหน้า / No Stock, Delivery Time : 30 - 60 Days

หมายเหตุ : ราคายังไม่รวมภาษี 7% บริษัทฯ ขอสงวนสิทธิ์ในการเปลี่ยนแปลงราคาโดยไม่ต้องแจ้งให้ทราบล่วงหน้า  
 Remarks : Excluded VAT 7%. The Company reserves the right to change the prices without announcement.



# Water Slides

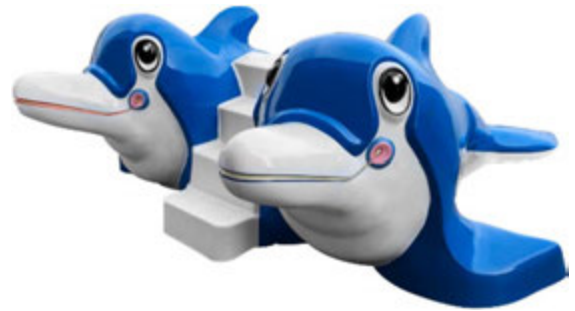

Code	Model	Description	Dimensions (cm)	Retail Price	Code✘
21401610010	DDS110✘	Twin Dolphins Sliders with Steps	W 260 x L 276 x H 110	72,000.00	A



Code	Model	Description	Dimensions (cm)	Retail Price	Code✘
21401610005	DS150✘	Single Dolphin Sliders with Steps	W 190 x L 470 x H 150	69,000.00	A

✘ สินค้าไม่มีสต็อก กรุณาสั่งซื้อล่วงหน้า / No Stock, Delivery Time : 30 - 60 Days

หมายเหตุ : ราคายังไม่รวมภาษี 7% บริษัทฯ ขอสงวนสิทธิ์ในการเปลี่ยนแปลงราคาโดยไม่ต้องแจ้งให้ทราบล่วงหน้า  
 Remarks : Excluded VAT 7%. The Company reserves the right to change the prices without announcement.



# Water Slides



Code	Model	Description	Dimensions (cm)	Retail Price	Code✘
21401610015	PSS-R	Right Turn Complete Set with Steps	W 52 x L 320 x H 195	65,000.00	A
21401610020	PSS-L	Left Turn Complete Set with Steps		65,000.00	



Code	Model	Description	Dimensions (cm)	Retail Price	Code✘
21401610025	PSS-CT✘	Close Tube Slider Complete Set with Steps	W 350 x L 350 x H 300	319,000.00	A

✘ สินค้าไม่มีสต็อก กรุณาสั่งซื้อล่วงหน้า / No Stock, Delivery Time : 30 - 60 Days

หมายเหตุ : ราคายังไม่รวมภาษี 7% บริษัทฯ ขอสงวนสิทธิ์ในการเปลี่ยนแปลงราคาโดยไม่ต้องแจ้งให้ทราบล่วงหน้า  
 Remarks : Excluded VAT 7%. The Company reserves the right to change the prices without announcement.



# Diving Boards

OUR BOARDS ARE SAFEST YOU CAN USE.....NO TWIST OR TORQUE, FASTER RECOVERY AND A PERMANENT NON-SLIP TREAT MEANS A SAFE, FUN FIVE EVERY TIME.

- The full width core of select, laminated Douglas Fir eliminates any torque or twist problems
- A molded fiberglass covering completely encases the core providing strength with maximum flexibility
- Heavily to the core at the fulcrum area makes this a board that will give you trouble-free service
- SANITREAD-Non-Slip top surface that resists wear. The safest diving surface ever devised



Code	Model	Description	Size	Retail Price	Code✘
21411610030	PSD-08-DUS	Diving Board Set Complete with Stainless Steel U-Stand	8 FT.	32,000.00	A
21411610040	PSD-10-DUS		10 FT.	37,000.00	
21411610050	PSD-12-DUS		12 FT.	44,000.00	



Code	Model	Description	Size	Retail Price	Code✘
21411610035	PSD-08-DFS	Diving Board Set Complete with	8 FT.	37,000.00	A
21411610045	PSD-10-DFS	Fiber Glass Stand	10 FT.	44,000.00	



Code	Model	Description	Size	Retail Price	Code✘	
21411610015	PSD-08-D	Diving Board	8 FT.	28,000.00	A	
21411610020	PSD-10-D		10 FT.	33,000.00		
21411610025	PSD-12-D		12 FT.	40,000.00		
21411610005	PSD-US	Stand Only	U-Stand Stainless Steel For Diving Board Size 8ft. / 10ft. / 12ft.			9,900.00
21411610010	PSD-FS-1		Fiberglass Stand For Diving Board Size 8ft.			12,000.00
21411610055	PSD-FS-2		Fiberglass Stand For Diving Board Size 10ft. / 12ft.			17,000.00

หมายเหตุ : ราคายังไม่รวมภาษี 7% บริษัทฯ ขอสงวนสิทธิ์ในการเปลี่ยนแปลงราคาโดยไม่ต้องแจ้งให้ทราบล่วงหน้า  
Remarks : Excluded VAT 7%. The Company reserves the right to change the prices without announcement.





# Aqua Scape Children Play Ground System

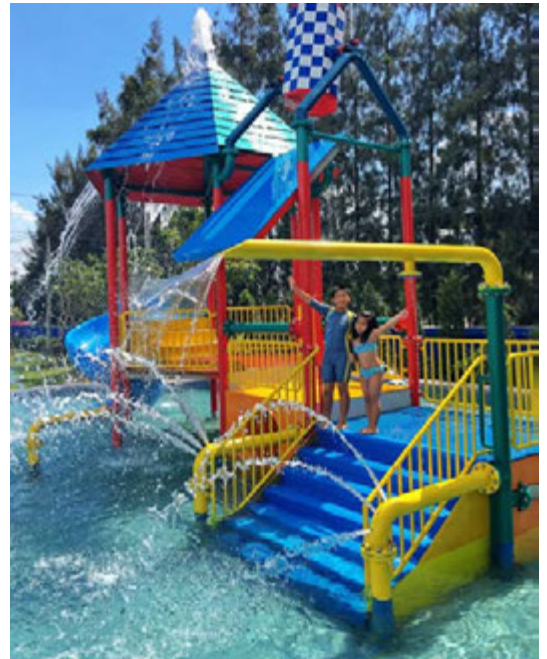

Suitable with EMAUX C-SE15 HP = 1 set

Code	Model	Flow @12m	Dimensions (cm)	Retail Price	Code✘
21421610015	Aqua Scape 220✘	250 m <sup>3</sup> /hr	W 461 x L 960 x H 500	กรุณาติดต่อเจ้าหน้าที่ / Please Check with Sales Assistance	

✘✘ราคาไม่รวมบ่มีม ขนส่งและติดตั้ง / Excluded pump, transportation & installation

✘ สินค้าไม่มีสต็อก กรุณาลงชื่อล่วงหน้า / No Stock, Delivery Time : 60 - 90 Days

หมายเหตุ : ราคายังไม่รวมภาษี 7% บริษัทฯ ขอสงวนสิทธิ์ในการเปลี่ยนแปลงราคาโดยไม่ต้องแจ้งให้ทราบล่วงหน้า  
 Remarks : Excluded VAT 7%. The Company reserves the right to change the prices without announcement.



# “AQUA SLIDE” Slider Size 42” Open Flume With Splash Guard At Curve

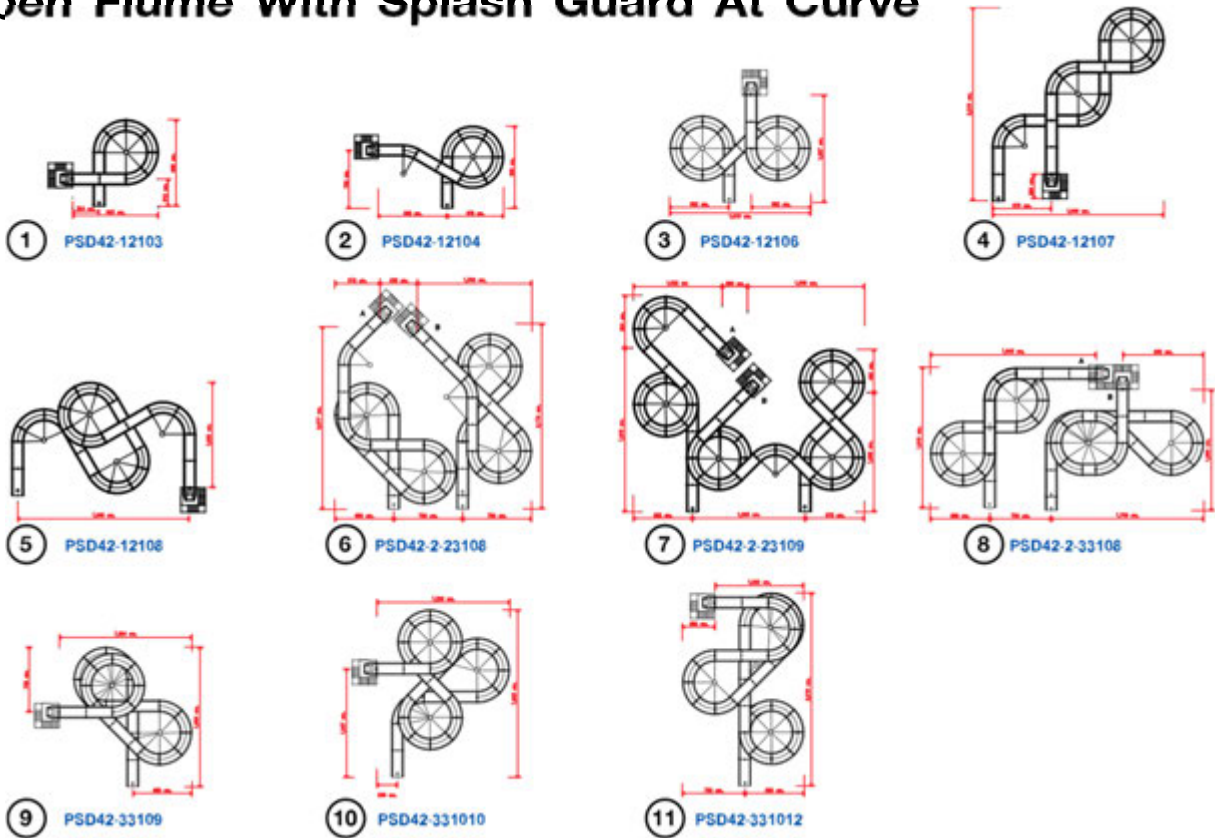

สไลเดอร์พร้อมชุดโครงเหล็กซีพพอร์ด / Fibreglass Slider & Hot Dip Galvanized Cast Iron Tower

Code	No.	Model	Slider Length (meters)	Retail Price	Code✖
21431610005	1	PSD42-12103 ✖	30.60	กรุณาติดต่อเจ้าหน้าที่ / Please Check with Sales Assistance	
21431610010	2	PSD42-12104 ✖	37.42		
21431610015	3	PSD42-23106 ✖	59.25		
21431610020	4	PSD42-12107 ✖	68.98		
21431610025	5	PSD42-11108 ✖	77.15		
21431610030	6	PSD42-2-23108 ✖	74.86		
			73.32		
21431610035	7	PSD42-2-23109 ✖	A - 85.10		
			B - 81.50		
21431610040	8	PSD42-2-33108 ✖	A - 78.60		
			B - 74.60		
21431610045	9	PSD42-33109 ✖	84.31		
21431610050	10	PSD42-331010 ✖	89.94		
21431610055	11	PSD42-331012 ✖	103.24		

✖✖ ราคาไม่รวมปั๊ม ขนส่งและติดตั้ง / Excluded pump, transportation & installation

✖ สินค้าไม่มีสต็อก กรุณาสั่งซื้อล่วงหน้า / No Stock, Delivery Time : 60 - 90 Days

หมายเหตุ : ราคายังไม่รวมภาษี 7% บริษัทฯ ขอสงวนสิทธิ์ในการเปลี่ยนแปลงราคาโดยไม่ต้องแจ้งให้ทราบล่วงหน้า  
Remarks : Excluded VAT 7%. The Company reserves the right to change the prices without announcement.





# SWIM JET SYSTEMS



# “EMAUX” Swim Set Systems

## COUNTER CURRENT JET

Perfect for small size pool where space is limited, a counter current jet system can ensure a decent swim for swimmer of all levels.

## APPLICATIONS

For fitness training, underwater massage endless no-lap swimming and unnecessary tumble turns

## FEATURES

- Powerful counter current
- Product can be used as a single or double jet system with one or two pumps
- Counter current face plate with LED light
- On/Off light switch mounted on the jet face please, easy access when you are in the water.
- Adjust the valve to control bubble effect
- Water flow can be changed through the rotating jet

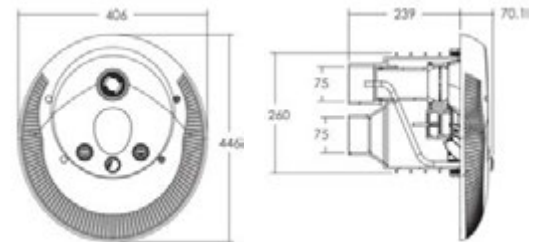

Water Pump Selection	Qmax		Hmax meter	V/Hz	Power	
	m <sup>3</sup> /h	l/min			kW	Horsepower
SR30 pump x 2	50	850	25	220/50	2 x 2.18	2 x 3.0

## Control Box



Countercurrent Jet Control Box [220V/380V]

Main Power input	Pump Power output	Lighting Power output
AC 220V/50Hz	AC 220V/50Hz, 4.4kW	AC12V, 1W
AC 380V/50Hz	AC 380V/50Hz, 4.4kW	AC12V, 1W

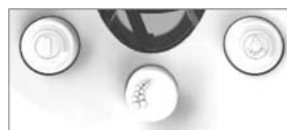

Underwater on/off Switch



Adjustable Nozzle and LED Light

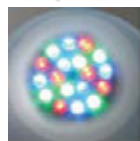

RGB Color Water Light



LED White Water Light





**Emaux Swim Jet Set A For 220V (SR30 x 2 pcs)**

Code	Model	Descriptions	Voltage	Retail Price	Code✘
21600510005	EM0055 – RGB	Counter Current Jet Complete Set with LED Light - RGB	220V / 1PH	79,900.00	B★
21630510005	SWJ-CB-220	Control Box 220V/1PH – Max. Operating Current 22Amp			
20700510295	SR30 – 220V	Jet Pump Model SR30 - 3.0HP/220V/1PH (2pcs)			
21640510005	08030107	EM0055 Piping Kit For 2 x SR30			

**Emaux Swim Jet Set B For 380V (SR30 x 2 pcs)**

Code	Model	Descriptions	Voltage	Retail Price	Code✘
21600510005	EM0055 - RGB	Counter Current Jet Complete Set with LED Light - RGB	380V / 3PH	79,900.00	B★
21630510010	SWJ-CB-380	Control Box 380V/3PH – Max. Operating Current 22Amp			
20700510300	SR30 – 380V	Jet Pump Model SR30 - 3.0HP/380V/3PH (2pcs)			
21640510005	08030107	EM0055 Piping Kit For 2 x SR30			



**Emaux Swim Jet Set C For 380V (UPH400 x 1 pc)**

Code	Model	Descriptions	Voltage	Retail Price	Code✘
21600510005	EM0055 - RGB	Counter Current Jet Complete Set with LED Light - RGB	380V / 3PH	92,000.00	B★
21630510010	SWJ-CB-380	Control Box 380V/3PH – Max. Operating Current 22Amp			
20700510495	UPH400	Pool Pump Model UPH400 – 4.0HP/380V/3PH (1pc)			
21640510015	91602204	EM0055 Piping Kit For 1 x UPH Pump			

**Parts**

Code	Model	Descriptions	Retail Price	Code✘
21600510005	EM0055 - RGB	Counter Current Jet Complete Set with LED Light - RGB	12,000.00	B★
21600510010	EM0055 - White	Counter Current Jet Complete Set with LED Light - White Colour	12,000.00	
21630510005	SWJ-CB-220	Control Box 220V/1PH	12,000.00	
21630510010	SWJ-CB-380	Control Box 380V/3PH	12,000.00	
21640510005	08030107	EM0055 Piping Kit For 2 x SR30	17,000.00	
21640510015	91602204	EM0055 Piping Kit For 1 x UPH Pump	19,000.00	

หมายเหตุ : ราคายังไม่รวมภาษี 7% บริษัทฯ ขอสงวนสิทธิ์ในการเปลี่ยนแปลงราคาโดยไม่ต้องแจ้งให้ทราบล่วงหน้า  
 Remarks : Excluded VAT 7%. The Company reserves the right to change the prices without announcement.



# “SPECK PUMPS” BADU Jet Turbo Pro Swim Against The Current Systems Made In Germany

With up to 350 m<sup>3</sup>/h, the BADUJET Turbo Pro has a considerably higher output performance than conventional units and at the same time is significantly quieter. The unit performance can be continuously adjusted with integrated sensor keys or via remote control. Thus, you can adapt the system perfectly to your individual needs: Performance-oriented training, professional workout, relaxation, rehabilitation training, fun.

### FIELD OF APPLICATION

For mounting into walls of all pool models, up to a wall thickness of 7 mm, except for round pools. For performance oriented professional workouts, relaxation, rehabilitation training, fitness or leisure.

### DESIGN

The built-in main housing uses innovative propeller technology to draw water in via the cover and return it to the swimming pool with a powerful stream. The system is driven by an efficient, fanless, fully encapsulated permanent magnet motor. Power control as well as switching the power on and off is carried out via the integrated piezo buttons or a remote control.

### DESIGN 1



### DESIGN 2

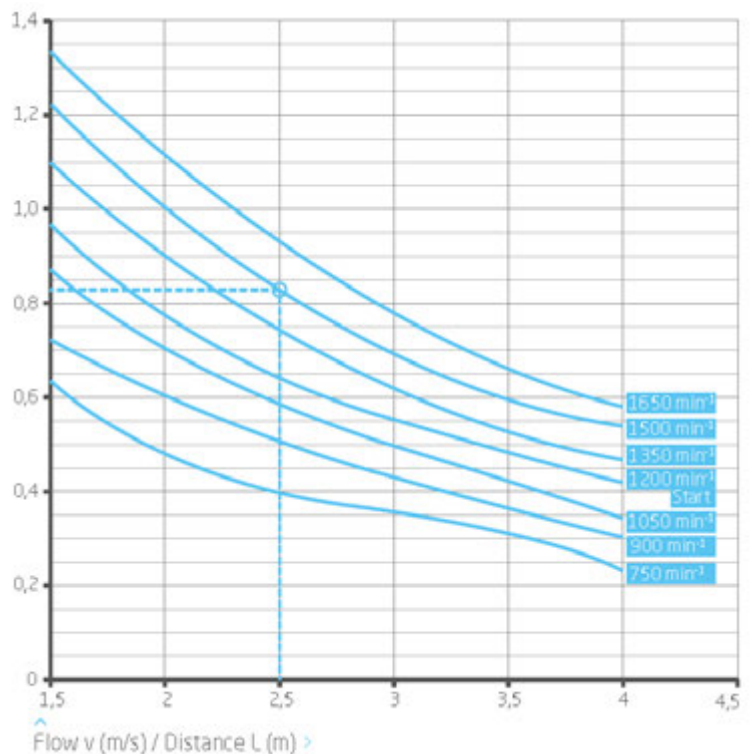



**STANDARD ASSEMBLY KIT FOR DESIGN 1 AND DESIGN 2**

- Plastic main housing
- Suction cover
- Stainless steel cover design 1 or design 2
- Magnet unit
- Nozzle unit
- Piezo buttons
- Seals
- Screws

**DRIVE SET 3 N~**

- Motor unit
- Frequency converter
- Control box
- Remote control
- Screws stainless steel V4A
- Shielded connection cable

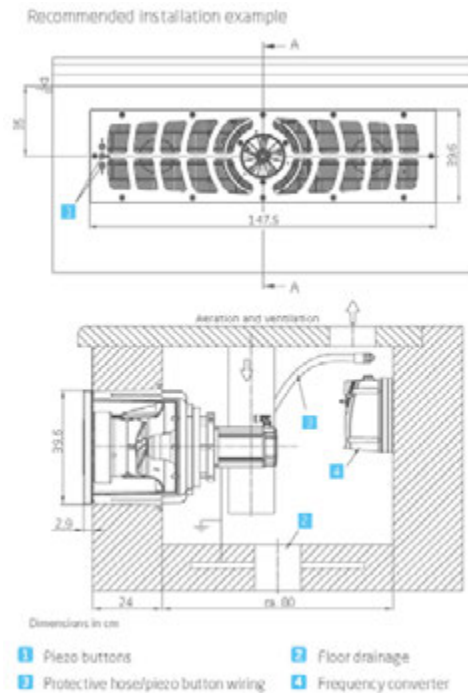
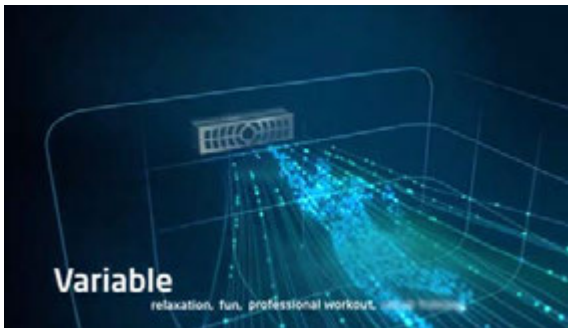

Technical data at 50/60 Hz	BADUJET Turbo Pro	Frequency converter
Performance (kW)	3~	4.00
Voltage	3~	3~ 380-480 V
Net weight (kg)	2~	6.00
Technical data at 50/60 Hz	BADUJET Turbo Pro	Drive unit
Pump flow rate (m <sup>3</sup> /h)	3~	150-350
Power input P <sub>1</sub> / output P <sub>2</sub> (kW)	3~	3.60/3.00
Number of nozzles (Ø 1.72 mm)	3~	1
Flow velocity (m/s)	3~	1.80-4.10
Multi-directional swivel nozzle (degrees)	3~	±5
Net weight (kg)	3~	51.50

For more detailed information regarding the motor protection please see page 143.

Code	Model	Flow Rate of the Pump (m <sup>3</sup> /hr)	Qty Nozzle Jet	Type	Power	Description	Retail Price	Code✘
20701930020	BADU JET Turbo Pro ✘	150 - 350	1	Built-In	380V/3PH	Stainless Steel body (NOT Suitable for Salt Water Pool)	กรุณาติดต่อเจ้าหน้าที่ / Please Check with Sales Assistance	

✘ สินค้าไม่มีสต็อก กรุณาลังซื้อล่วงหน้า / No Stock, Delivery Time : 30 - 60 Days

หมายเหตุ : ราคายังไม่รวมภาษี 7% บริษัทฯ ขอสงวนสิทธิ์ในการเปลี่ยนแปลงราคาโดยไม่ต้องแจ้งให้ทราบล่วงหน้า  
Remarks : Excluded VAT 7%. The Company reserves the right to change the prices without announcement.





# “SPECK PUMPS” BADU Jet Super Sport Series Swim Against The Current Systems Made In Germany

**WATER TREADMILL**

The full featured BaduJet offers suction and discharge in a unique, patented, one-piece dual nozzle housing. Volume control ON/OFF are conveniently located on the face of the jet housing

**FEATURES**

- A. Flush mounted, plastic housing , 16” diameter.
- B. Rectangle anti-entrapment cover provides undetectable suction(20” x 17”)
- C. Adjustable recessed jet nozzles
- D. Volume control knob adjusts flow of water.
- E. Pneumatic (NO/OFF) button guarantees complete separation between pool water and pump motor control.
- F. Air regulator controls amount of air bubbles in water flow.
- G. Tubing for pneumatic button, 50ft (not shown)
- H. Control box with GFCI.
- I. Speck 4.0 HP self-priming plastic pump. UL Listed, with thermal overload
- J. Massage Hose with pulsator may be attached to jet nozzle (Options)

**APPLICATIONS**

- Perfect for in-ground & above ground pools (Commercial & Residential)



Complies with ETL, ESD, CSA & IEC 27706 & 27708 & 27709  
Pressure Pumps (Submersible)  
Listing #622249



VGB 2008

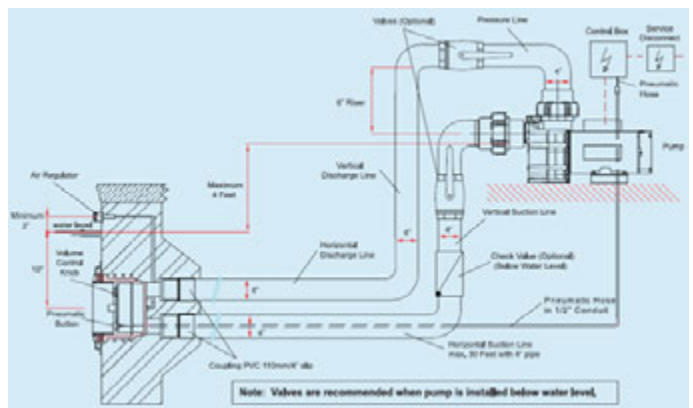

Code	Model	Flow Rate of the Pump (m <sup>3</sup> /hr)	Qty Nozzle Jet	Type	Power	Description	Retail Price	Code✘
21611930015	BADU JET Super Sport ✘	75	2	Built-In	380V/3PH	Swim Jet & Complete set with Pump & LED Light	319,000.00	B



Code	Model	Description	Retail Price	Code✘
20711930225	2300001000 ✘	Massage for large nozzle, 40mm	กรุณาติดต่อเจ้าหน้าที่ / Please Check with Sales Assistance	

✘ สินค้าไม่มีสต็อก กรุณาสั่งซื้อล่วงหน้า / No Stock, Delivery Time : 30 - 60 Days

หมายเหตุ : ราคายังไม่รวมภาษี 7% บริษัทฯ ขอสงวนสิทธิ์ในการเปลี่ยนแปลงราคาโดยไม่ต้องแจ้งให้ทราบล่วงหน้า  
Remarks : Excluded VAT 7%. The Company reserves the right to change the prices without announcement.



# “SPECK PUMPS” BADU Jet Stella Series

## Swim Against The Current Systems

### Made In Germany

The most powerful under the BADU Jet overhang counter swim units. Furthermore even sports-mad pool owners get their money worth. With two adjustable flow and direction control nozzles and integrated LED lighting in which or multicolor, ensures a pleasant ambience, additional accessories are available as an option



**TECHNICAL DATA AT 50HZ**

Jet-pump	21-81/33G.
Flow rate of the pump	75m <sup>3</sup> /h
Voltage	3 N – 400/230V
Power input P1	3.80 kW
Power input P2	3.00 kW
Flow pressure at nozzle	1.00 bar
Flow velocity in center 2 m from nozzle	1.40 bar
Massage pressure max	1.60 bar
Number of nozzles diameter 40 mm	2
Omnidirectional swivel nozzle	60 degrees
Weight	54/60 kgs

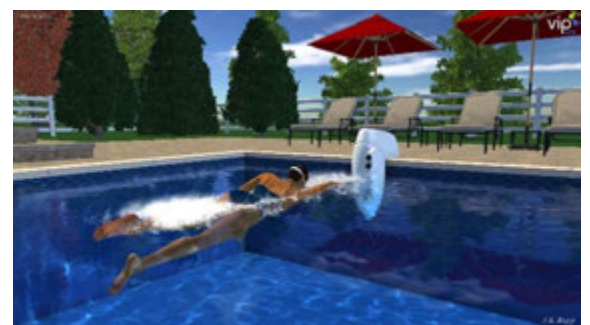
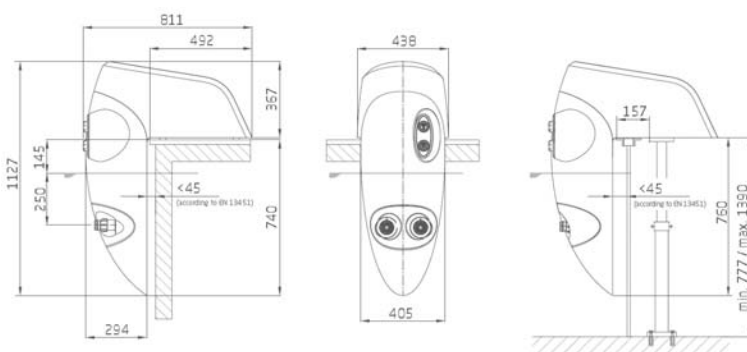

Code	Model	Flow Rate of the Pump (m <sup>3</sup> /hr)	Qty Nozzle Jet	Type	Power	Description	Retail Price	Code✘
21611930030	BADU JET Stella	75	2	Wall Hang	380V/3PH	Complete set with Pump & LED Light	259,000.00	B

หมายเหตุ : ราคายังไม่รวมภาษี 7% บริษัทฯ ขอสงวนสิทธิ์ในการเปลี่ยนแปลงราคาโดยไม่ต้องแจ้งให้ทราบล่วงหน้า  
 Remarks : Excluded VAT 7%. The Company reserves the right to change the prices without announcement.



# “SPECK PUMPS” BADU Stream Series

## Swim Jet Body

### Made In Germany

**BADU STREAM FOR NEW POOLS**

The BADU Stream Jet System offers many different packages in a wide price range, to satisfy a variety of exercise styles and budgets. The system accommodates installation in limited space and carrying pool wall designs.

- The BADU Stream can be used as a single, double or triple jet system with one or two pumps.
- A single jet system generates a narrow and faster stream and is the most economical swimjet system.
- With two jets, it is perfect for the recreational swimmer with an intermediate level of exercise.
- The most powerful system available is out three jets/two pump system, providing the ultimate performance for higher levels of exercise.
- The BADU Stream can be installed in vinyl liner, steel wall, fiberglass and gunite pools.
- Each BADU Stream jet is a flush mounted anti-entrapment combination fitting in its own housing
- Options include a therapeutic pulsating massage house, perfect for relaxing after a workout



Code	Model	In / Outlet	Type	Description	Retail Price	Code✕
21601930005	BADU Jet Stream	3"	Built-In	Housing with Air Valve Control Only	39,000.00	B

หมายเหตุ : ราคายังไม่รวมภาษี 7% บริษัทฯ ขอสงวนสิทธิ์ในการเปลี่ยนแปลงราคาโดยไม่ต้องแจ้งให้ทราบล่วงหน้า  
 Remarks : Excluded VAT 7%. The Company reserves the right to change the prices without announcement.

# HEATING SYSTEMS





## “HELIOCOL” Solar Heating System

Heliocol collectors are constructed like no other. Unique design characteristics make Heliocol the best solar pool heating system available. The balance between design and excellence and rugged durability make Heliocol the smart choice for your residential or commercial needs.

Standard Pool temperature : 28 – 30°C

### DESIGN FEATURES

Heliocol is the world’s largest solar pool heating manufacturer. Our panels have several patented design features. We pride ourselves on being environmentally safe, maintenance free and roof friendly. If there would be any issues, Heliocol has you covered with a twelve year limited warranty including freeze protection.

#### 1. One-Piece Unibody Construction

The overmolded header is formed over each individual tube and fused together during construction, producing the strongest possible connection. Overmolding eliminates cracks and welds for a longer lasting, maintenance-free system.

#### 2. Individual Tubes

Open design resists lift and stays put even in high winds. Protects the roof from rain rot by allowing rapid moisture evaporation. Round tubes capture more heat.

#### 3. Mounting Sleds

Sleds maintain alignment of individual riser tubes. Prevent abrasion to panel and roof when expanding and contracting.

#### 4. Panel Clamps

Patented panel clamps eliminate rubber hoses and metal clamps that require regular rooftop maintenance and replacement, eliminating hassles and saving time and money. Clamps also allow panels to be mounted closer together for a more efficient and more attractive system.

#### 5. Gator Clamps

Strapless mounting allows for expansion and contraction and fewer roof penetrations.

#### 6. Open Flow Design

Each and every individual tube opens into the header, increasing flow and virtually eliminating backpressure, saving wear and tear on pool pumps.





Collector Data

Collector Model	HC-50
Size, Nominal	4' x 12.5'
Width	46.56"
Length	151.44"
Aperture Area	48.23 sq ft
Manifold Diameter	2"
Dry Weight	22 lbs
Volume Capacity	3.7 gal
Working Pressure	90 psi
Burst Pressure	270 psi
Typical Flow	5 - 7 gpm

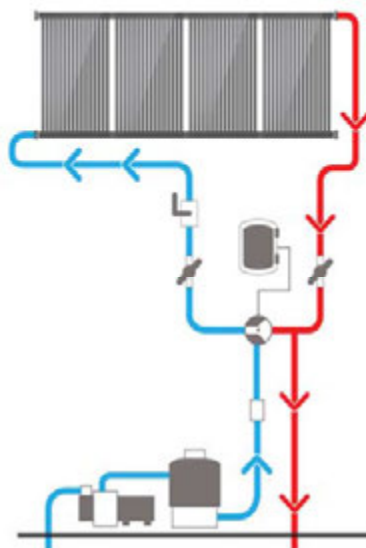

HC-50

Solar Insolation

Category T (°F)		2,000 BTU/ft <sup>2</sup>	1,500 BTU/ft <sup>2</sup>	1,000 BTU/ft <sup>2</sup>
Water Temp. Minus Air Temp.	A (-9)	101.26	77.17	57.88
	B (+9)	48.23	28.94	9.65
	C (+36)	4.82	0	0
	D (+90)	0	0	0

Thousands of BTU's per day per panel

Code	Model	Pool Area (กว้าง x ยาว)	Quantity of Panels	Roof Area (Sq.M.)	Retail Price	Code✘
21700810010	10 HC-50✘	50 Sq.M.	10	48	359,000.00	B
21700810015	15 HC-50✘	70 Sq.M.	15	71	529,000.00	
21700810020	22 HC-50✘	100 Sq.M.	22	103	749,800.00	
21700810025	30 HC-50✘	150 Sq.M.	30	140	939,000.00	



Code	Model	Description	Retail Price	Code✘
21710810005	MS3D✘	Ascon Automatic Temperature Controller	59,000.00	B

✘ สินค้าไม่มีสต็อก กรุณาสั่งล่วงหน้า 60-90 วัน / No Stock, Delivery Time 60-90 Days

หมายเหตุ : ราคายังไม่รวมภาษี 7% บริษัทฯ ขอสงวนสิทธิ์ในการเปลี่ยนแปลงราคาโดยไม่ต้องแจ้งให้ทราบล่วงหน้า  
Remarks : Excluded VAT 7%. The Company reserves the right to change the prices without announcement.



# “EMAUX” DC Inverter Swimming Pool Heat Pump

## HIGH COP TO SAVE ENERGY COST

Provides you a simple saving and silent warm pool

Industry-leading efficient step-less DC inverter control system. With the smart conversion of the compressor, fan motor and pressure system, it provides amazing energy-saving performance with a max COP of 16.1.

- 1. Double-side Airflow Outlet** The unit uses a double-side airflow cabinet which through years of application in the market is proven to be highly efficient in heat exchange and outstandingly silent during operation.
- 2. Optional Noise Absorbing Cover** On the cabinet, the lively interplay of sheet metal surfaces combined with irregularly shaped patterns is reminiscent of high-performance swimming pool heat pump products. More importantly, the noise absorption cover effectively reduces 8dB(A).



25% gas quota of R410a

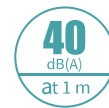

Quiet as a fridge



Average COP 10.7  
93% free energy



Mitsubishi Twin-Rotary Inverter Compressor



Stepless Comfort Speed Conversion



DC Brushless Fan Motor

## FEATURES

- Low Noise Running
- Double-side Airflow Outlet
- Optional Noise Absorbing Cover
- Eco-friendly R32
- Wide Voltage Application
- More than 93% free energy



Original Italian Carel Controller



Optional Noise Absorbing Cover



Garden Friendly Flat Surface Design

## Save Energy and Speed up Heating Time

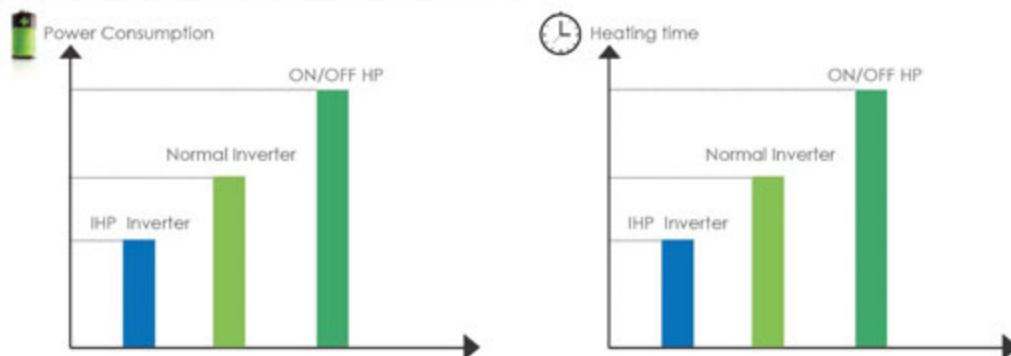

With short heating time, users don't need to wait for a long time before enjoying swimming. In the mean while, it saves more energy than ON/OFF heat pump and normal inverter heat pump.



Maintain High COP in Different Ambient Conditions

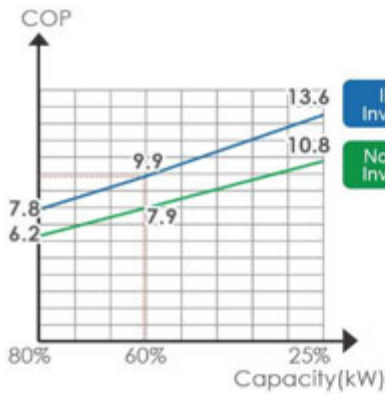

Performance condition:  
Air 27°C/Water 26°C/Humidity 80%

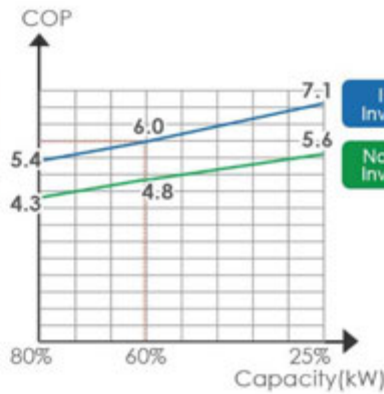

Performance condition:  
Air 15°C/Water 26°C/Humidity 70%

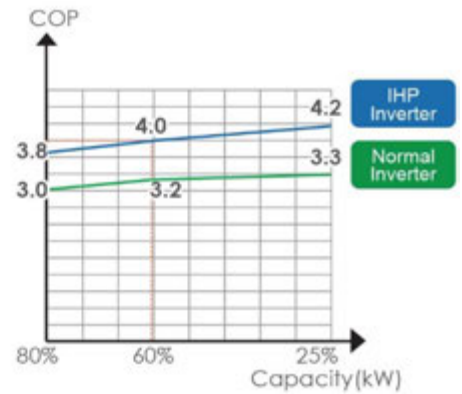

Performance condition:  
Air 2°C/Water 26°C/Humidity 80%

Product Information

Model	Heating capacity in A27°C/ W27°C (kW)	COP Range	Heating capacity in A15°C/ W26°C (kW)	COP Range	Operating Temp.	Heating Input Power (kW)	Rated Heating Running Current (A)	Noise (Min-Max) dB(A)	Water Connections (mm)
IHP13	3.5-13.5	6-16	2-9.5	4.5-8	-15°C	0.22-2.2	1-10	42-50	50/48.3
IHP18	4.5-18	6-16	2.5-12	4.5-8	-15°C	0.35-3.2	1.8-15	42-50	50/48.3
IHP21	5-21	6.1-16.1	3-14.5	4.6-8.1	-15°C	0.4-3.4	1.8-15.5	42-52	50/48.3
IHP26	7-26	6-15.5	4-18	4.5-8.1	-15°C	0.5-4.3	2.3-21	43-53	50/48.3
IHP36	9-36	6-16	6-24	4.5-8	-15°C	0.75-6	3.4-27.3	46-54	50/48.3
IHP36S	9-36	6-16	6-24	4.5-8	-15°C	0.75-6	1.3-10.7	46-54	50/48.3

Product Dimensions

Model	Net weight (KG)	Gross weight (KG)	Net dimensions (without front cover) (mm)	Packing dimensions (without front cover) (mm)	Net dimensions (with front cover) (mm)	Packing dimensions (with front cover) (mm)
IHP13	50	58	970*370*650	1170*415*800	970*470*650	1170*515*800
IHP18	55	63	970*370*650	1170*415*800	970*470*650	1170*515*800
IHP21	75	85	1115*430*850	1200*520*990	1115*530*850	1200*620*990
IHP26	78	88	1115*430*850	1200*520*990	1115*530*850	1200*620*990
IHP36	120	135	1115*430*1350	1200*520*1500	1115*530*1350	1200*620*1500
IHP36S	120	135	1115*430*1350	1200*520*1500	1115*530*1350	1200*620*1500

Code	Model	Heating Capacity (KW)	Voltage	Phase	Frequency (Hz)	Retail Price	Code✖
21700510095	IHP13✖	3.5-13.5	220~230	1	50	190,000.00	B
21700510100	IHP18✖	4.5-18	220~230	1	50	220,000.00	
21700510105	IHP21✖	5-21	220~230	1	50	270,000.00	
21700510110	IHP26✖	7-26	220~230	1	50	290,000.00	
21700510115	IHP36✖	9-36	220~230	1	50	360,000.00	
21700510120	IHP36S✖	9-36	380~415	3	50	380,000.00	

✖ สินค้าไม่มีสต็อก กรุณาสั่งล่วงหน้า 60-90 วัน / No Stock, Delivery Time 60-90 Days

หมายเหตุ : ราคายังไม่รวมภาษี 7% บริษัทฯ ขอสงวนสิทธิ์ในการเปลี่ยนแปลงราคาโดยไม่ต้องแจ้งให้ทราบล่วงหน้า  
Remarks : Excluded VAT 7%. The Company reserves the right to change the prices without announcement.





# “EMAUX” B2 Series Heat Pump

### Product Features

- Durable** The heating exchanger is made by PVC & Titanium tube, which can withstand prolonged exposure to swimming pool water.
- Easy Operation** The heating exchanger is made by PVC & Titanium tube, which can withstand prolonged exposure to swimming pool water.
- Quiet Operation** The unit comprises an efficient rotary compressor and a low-noise fan motor, which guarantees its quiet operation.
- Low Cost** The operational cost is very low due to its high performance



### Measuring Conditions

Heating : Dry bulb 24°C, Wet Bulb 19°C, Water entering temperature 27°C

Model	A (mm)	B (mm)	C (mm)	D (mm)	E (mm)	F (mm)	G (mm)	H (mm)
HP4.5B2	260	293	754	770	100	260	460	485
HP5.6B2	280	360	936	950	110	250	520	550
HP7.8B2	280	360	936	950	110	250	520	550
HP9.5B2	300	370	1010	1085	110	270	580	615

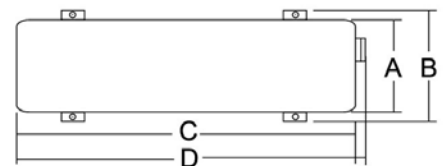

### Product Information

Model	Net Dimensions L x W x H (mm)	Packing Dimensions L x W x H (mm)	Net Weight (kg)	Gross Weight (kg)
HP4.5B2	754 x 293 x 485	760 x 295 x 490	36	39
HP5.6B2	936 x 360 x 550	1090 x 390 x 580	39	42
HP7.8B2	936 x 360 x 550	1090 x 390 x 580	54	57
HP9.5B2	1010 x 370 x 615	1170 x 415 x 645	63	67

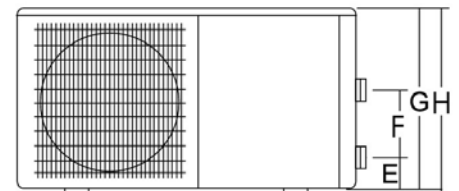

Model	Heating Capacity in A27°C/W27°C (W)	Heating Capacity in A15°C/W26°C (W)	Rated Heating Capacity (W/BTU)	Heating Input Power (W)	Heating Running Current (A)	Power Supply (V/PH/Hz)
HP4.5B2	5500	4000	4500/15300	1050	4.8	220V/1PH/50Hz
HP5.6B2	6200	4500	5600/18000	1250	5.7	220V/1PH/50Hz
HP7.8B2	8900	6100	7800/26500	1650	7.5	220V/1PH/50Hz
HP9.5B2	11500	8200	9500/32500	1978	10	220V/1PH/50Hz

Code	Model	BTU	Voltage	Phase	Frequency (Hz)	Retail Price	Code✳
21700510005	HP4.5B2 ✳	15300	220	1	50	75,000.00	B
21700510010	HP5.6B2 ✳	18000	220	1	50	89,000.00	
21700510015	HP7.8B2 ✳	26500	220	1	50	99,000.00	
21700510020	HP9.5B2 ✳	32500	220	1	50	110,000.00	

✳ สินค้าไม่มีสต็อก กรุณาสั่งล่วงหน้า 60-90 วัน / No Stock, Delivery Time 60-90 Days

หมายเหตุ : ราคายังไม่รวมภาษี 7% บริษัทฯ ขอสงวนสิทธิ์ในการเปลี่ยนแปลงราคาโดยไม่ต้องแจ้งให้ทราบล่วงหน้า

Remarks : Excluded VAT 7%. The Company reserves the right to change the prices without announcement.



# “EMAUX” B Series Heat Pump

## Product Features

- High Efficiency** with a COP value up to 5.0 our heat pumps are very efficient when transferring heat from the air to the swimming pool water. You can save as much as 80 % of cost compared to an electrical heater.
- Long Life-Span** The heat exchanger is made by PVC & Titanium tube, which can withstand and prolong exposure to swimming pool water.
- Easy Control and Operation** Simply switch it on and set the desired pool water temperature. The system includes a micro-computer controller, allowing all operation parameters to be set. Operation status can be displayed on the controller with LCD display.



## Measuring Conditions

Heating : Dry bulb 24°C, Wet Bulb 19°C, Water entering temperature 27°C

Cooling : Dry bulb 35°C, Wet Bulb 24°C, Water entering temperature 27°C

Model	A (mm)	B (mm)	C (mm)	D (mm)	E (mm)	F (mm)	G (mm)	H (mm)
HP5.6B	280	360	936	950	110	250	520	550
HP7.8B	280	360	936	950	110	250	520	550
HP9.5B	300	370	1010	1085	110	270	580	615
HP14B	420	470	1100	1150	80	350	664	700

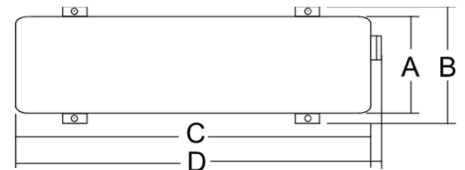

## Product Information

Model	Net Dimensions L x W x H (mm)	Packing Dimensions L x W x H (mm)	Net Weight (kg)	Gross Weight (kg)
HP5.6B	936 x 360 x 550	1090 x 390 x 580	53	56
HP7.8B	936 x 360 x 550	1090 x 390 x 580	54	57
HP9.5B	1010 x 370 x 615	1170 x 415 x 645	63	67
HP14B	1170 x 470 x 690	1240 x 500 x 750	95	105

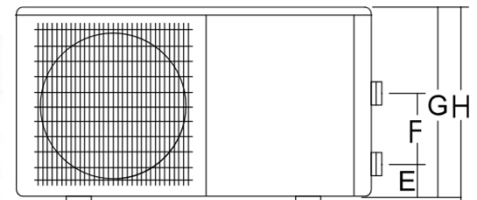

Model	Heating Capacity in A27°C/W27°C (W)	Heating Capacity in A15°C/W26°C (W)	Rated Heating Capacity (W/BTU)	Heating Input Power (W)	Heating Running Current (A)	Rated Cooling Capacity (W/BTU)	Cooling Input Power (W)	Cooling Running Current (A)	Power Supply (V/PH/Hz)
HP5.6B	6100	4500	5600/18000	1083	5.0	3200/11000	1030	4.7	220V/1PH/50Hz
HP7.8B	8900	6500	7800/26500	1625	7.5	4800/16500	1550	7.1	220V/1PH/50Hz
HP9.5B	11500	8000	9500/32500	1938	8.8	5900/20000	1910	8.7	220V/1PH/50Hz
HP14B	15500	11000	14000/48000	2880	13.3	8600/29500	2980	13.8	220V/1PH/50Hz

Code	Model	BTU	Voltage	Power (W)	Frequency (Hz)	Retail Price	Code✖
21700510025	HP5.6B ✖	18000	220	5600	50	95,000.00	B
21700510030	HP7.8B ✖	26500	220	7800	50	119,000.00	
21700510035	HP9.5B ✖	32500	220	9500	50	129,000.00	
21700510090	HP14B ✖	48000	220	14000	50	220,000.00	

✖ สินค้าไม่มีสต็อก กรุณาสั่งล่วงหน้า 60-90 วัน / No Stock, Delivery Time 60-90 Days

หมายเหตุ : ราคายังไม่รวมภาษี 7% บริษัทฯ ขอสงวนสิทธิ์ในการเปลี่ยนแปลงราคาโดยไม่ต้องแจ้งให้ทราบล่วงหน้า  
Remarks : Excluded VAT 7%. The Company reserves the right to change the prices without announcement.



# “EMAUX” A Series Heat Pump

### Product Features

- High Efficiency** with a COP value up to 5.0 our heat pumps are very efficient when transferring heat from the air to the swimming pool water. You can save as much as 80 % of cost compared to an electrical heater.
- Long Life-Span** The heat exchanger is made by PVC & Titanium tube, which can withstand and prolong exposure to swimming pool water.
- Easy Control and Operation** Simply switch it on and set the desired pool water temperature. The system includes a micro-computer controller, allowing all operation parameters to be set. Operation status can be displayed on the controller with LCD display.



HP14A-26A

## Measuring Conditions

Heating : Dry bulb 24°C, Wet Bulb 19°C, Water entering temperature 27°C  
 Cooling : Dry bulb 35°C, Wet Bulb 24°C, Water entering temperature 27°C

Model	D (mm)	E (mm)	F (mm)	G (mm)	H (mm)
HP14A	860	660	660	320	95
HP17A	860	660	660	450	95
HP21A	960	660	660	450	95
HP26A	960	660	660	500	95

Model	A (mm)	B (mm)	C (mm)	D (mm)	E (mm)	F (mm)	G (mm)
HP35A	1448	690	700	770	1080	435	135
HP50A	1448	690	700	770	1280	506	120
HP90A	2150	690	700	770	1280	125	480
HP105A	2160	950	1100	1100	2030	180	380
HP135A	2160	950	1100	1100	2030	180	420



# “EMAUX” A Series Heat Pump

## Product Information

Model	Net Dimension L x W x H (mm)	Packing Dimension L x W x H (mm)	Net Weight (kg)	Gross Weight (kg)
HP14A	660 x 660 x 860	770 x 740 x 1010	105	113
HP17A	660 x 660 x 960	770 x 740 x 1110	108	120
HP21A	660 x 660 x 960	770 x 740 x 1110	111	123
HP26A	660 x 660 x 960	770 x 740 x 1110	112	125
HP35A	1448 x 730 x 1080	1630 x 830 x 1350	242	270
HP50A	1448 x 730 x 1280	1630 x 830 x 1450	243	272
HP90A	2150 x 770 x 1280	2275 x 900 x 1500	250	280
HP105A	2160 x 1100 x 2030	2200 x 1220 x 2150	600	630
HP135A	2160 x 1100 x 2030	2200 x 1220 x 2150	630	660



HP35A-50A

Model	Heating Capacity in A27°C/W27°C (W)	Heating Capacity in A15°C/W26°C (W)	Rated Heating Capacity (W/BTU)	Heating Input Power (W)	Heating Running Current (A)	Rated Cooling Capacity (W/BTU)	Cooling Input Power (W)	Cooling Running Current (A)	Power Supply (V/PH/Hz)
HP14A	15800	11000	14000/48000	2880	13.3	8600/48000	2980	13.8	220V/1PH/50Hz
HP17A	19000	12250	17000/60000	3500	16.1	10300/35200	3600	16.9	220V/1PH/50Hz
HP21A	23000	14800	21000/73000	4250	7.9	13500/46000	4650	8.3	380V/3PH/50Hz
HP26A	27500	18000	26000/90000	5300	9.5	16000/55000	5730	10.5	380V/3PH/50Hz
HP35A	39000	25000	35000/120000	7100	12.3	29000/100000	9600	17.3	380V/3PH/50Hz
HP50A	55000	36000	50000/170000	10300	18.4	36000/123000	12100	21.6	380V/3PH/50Hz
HP90A	93000	61000	90000/306000	17500	31.2	58000/200000	18800	33.5	380V/3PH/50Hz
HP105A	120000	70000	105000/357000	22800	40.3	78000/266000	25100	44.8	380V/3PH/50Hz
HP135A	140000	92000	135000/459000	26800	47.8	96000/327000	28500	50.9	380V/3PH/50Hz



HP90A

Model	Controller	Quantity of Compressor	Compressor	Quantity of Fan	Input Power of Fan (W)	Fan Speed (RPM)	Noise Db (A)	Water Connection (mm)	Water Flow Volume (m <sup>3</sup> /h)	Water Pressure Drop (kpa)
HP14A	Electronic	1	Scroll	1	200	850	60	50	5-8	15
HP17A	Electronic	1	Scroll	1	200	830	60	50	5-8	16
HP21A	Electronic	1	Scroll	1	200	830	60	50	6-10	16
HP26A	Electronic	1	Scroll	1	200	830	60	50	6-12	16
HP35A	Electronic	2	Scroll	2	200 x 2	830	61	63	8-15	18
HP50A	Electronic	2	Scroll	2	200 x 2	830	61	63	8-15	18
HP90A	Electronic	3	Scroll	3	200 x 3	830	61	63	35-55	28
HP105A	Electronic	4	Scroll	2	750 x 2	830	61	75	45-55	31
HP135A	Electronic	4	Scroll	2	750 x 2	830	61	75	55-65	32



HP105A-135A

Code	Model	BTU	Voltage	Power (W)	Frequency (Hz)	Retail Price	Code✖
21700510040	HP14A ✖	48000	220	14000	50	229,000.00	B
21700510045	HP17A ✖	60000	220	17000	50	239,000.00	
21700510070	HP21A ✖	73000	220	21000	50	249,000.00	
21700510050	HP21A ✖	73000	380	21000	50	249,000.00	
21700510055	HP26A ✖	90000	380	26000	50	279,000.00	
21700510060	HP35A ✖	120000	380	35000	50	659,000.00	
21700510065	HP50A ✖	170000	380	50000	50	759,000.00	
21700510075	HP90A ✖	306000	380	90000	50	กรุณาติดต่อเจ้าหน้าที่ / Please Check with Sales Assistance	
21700510080	HP105A ✖	357000	380	105000	50		
21700510085	HP135A ✖	459000	380	135000	50		

✖ สินค้าไม่มีสต็อก กรุณาสั่งล่วงหน้า 60-90 วัน / No Stock, Delivery Time 60-90 Days

หมายเหตุ : ราคายังไม่รวมภาษี 7% บริษัทฯ ขอสงวนสิทธิ์ในการเปลี่ยนแปลงราคาโดยไม่ต้องแจ้งให้ทราบล่วงหน้า  
Remarks : Excluded VAT 7%. The Company reserves the right to change the prices without announcement.

# POOL & SPA FITTINGS







**“POOLSPA” GSW Series  
Standard Gratings Plastic ABS Grade A  
With UV Stabilized**



Code	Model	Type	Length (cm)	Height (cm)	Connection	Qty / meters	Colour	Retail Price	Code✖
22001610020	GSW-2510	Standard	25	3.3	Single	42	White	1,100.00	B★
22001610095	GSC-2510						Cream	1,100.00	
22001610030	GSB-2510						Black	2,200.00	



Code	Model	Type	Length (cm)	Height (cm)	Connection	Qty / meters	Colour	Retail Price	Code✖
22001610035	GSW-2520	Standard	25	2.5	Double	51	White	1,100.00	B★
2230230121	GSC-2520						Cream	1,100.00	
22001610045	GSB-2520						Black	2,200.00	
22001610065	GSW-3020		30	2.5	Double	51	White	1,320.00	
2230230521	GSC-3020						Cream	1,320.00	
22001610075	GSB-3020						Black	2,640.00	

หมายเหตุ : ราคายังไม่รวมภาษี 7% บริษัทฯ ขอสงวนสิทธิ์ในการเปลี่ยนแปลงราคาโดยไม่ต้องแจ้งให้ทราบล่วงหน้า  
Remarks : Excluded VAT 7%. The Company reserves the right to change the prices without announcement.



# “POOLSPA” GWW Series Wave Killer Gratings Plastic ABS Grade A With UV Stabilized

- Bend ability in accordance with regulations
- Breakwater effect
- Comfort and non-slip effect



Code	Model	Type	Length (cm)	Height (cm)	Connection	Qty / meters	Colour	Retail Price	Code✖
22001610005	GWW-2010	Wave Killer	20	3	Single	49	White	1,100.00	B★
2230230096	GWC-2010						Cream	1,100.00	
2230230088	GWB-2010						Black	2,200.00	
22001610050	GWW-2510		25	3	Single	49	White	1,300.00	
2230230152	GWC-2510						Cream	1,300.00	
2230230560	GWB-2510						Black	2,600.00	
22001610080	GWW-3010		30	3	Single	49	White	1,500.00	
2230230545	GWC-3010						Cream	1,500.00	
22001610090	GWB-3010						Black	3,000.00	

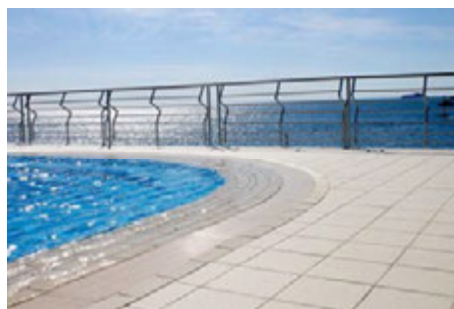
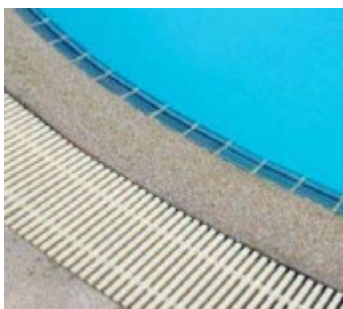

หมายเหตุ : ราคายังไม่รวมภาษี 7% บริษัทฯ ขอสงวนสิทธิ์ในการเปลี่ยนแปลงราคาโดยไม่ต้องแจ้งให้ทราบล่วงหน้า  
Remarks : Excluded VAT 7%. The Company reserves the right to change the prices without announcement.





# “POOLSPA” PSL Series

## 2 Inches Stainless Steel Ladders

### Complete Set For Chlorine & Salt Water Pools

Vertical General Purpose ladder for all types of pool.

Each ladder comes standard with two frames and injection molded ABS-UV inhibited steps bolted between them. All frames are made of corrosion resistant T304 stainless steel. All ladder styles with frames resting against the pool wall have rubber bumpers to prevent damage to the wall.

**FEATURES**

- Heavy Duty Ladder - Made only in thicker grades of stainless steel to with stand heavier usage.
- Heavy Duty with Cross Brace - Recommended for heavy duty commercial use at pools. Reinforced with cross brace for extra strength and rigidity.
- Deluxe - For right commercial or residential pools.



Code	Model	Description	Step Quantity	Retail Price	Code✖
21811610005	PSL-2-C-304	S.S.304 For Chlorine Pool Complete Set with ABS Steps	2 Steps	12,000.00	H★
21811610015	PSL-3-C-304		3 Steps	14,000.00	
21811610025	PSL-4-C-304		4 Steps	18,000.00	
21811610010	PSL-2-C-316	S.S.316 For Salt Water Pool Complete Set with ABS Steps	2 Steps	21,000.00	
21811610020	PSL-3-C-316		3 Steps	27,000.00	
21811610030	PSL-4-C-316		4 Steps	32,000.00	

หมายเหตุ : ราคายังไม่รวมภาษี 7% บริษัทฯ ขอสงวนสิทธิ์ในการเปลี่ยนแปลงราคาโดยไม่ต้องแจ้งให้ทราบล่วงหน้า  
 Remarks : Excluded VAT 7%. The Company reserves the right to change the prices without announcement.



# “POOLSPA” PSL Series

## 2 Inches Stainless Steel Ladders

### For Chlorine & Salt Water Pools

Grab rails come in pairs. They are used to keep racing lanes free of obstructions when used in conjunction with built-in step.



Code	Model	Description	Retail Price	Code✘
21811610035	PSL-BR-304	2” Built-in Stainless Rail Complete Set	11,000.00	H★
21811610040	PSL-BR-316	2” Built-in Stainless Rail Complete Set	18,000.00	

Code	Model	Description	Retail Price	Code✘
21821610010	PSL-BS	Built-in Fiber Glass Step	2,900.00	H★

หมายเหตุ : ราคายังไม่รวมภาษี 7% บริษัทฯ ขอสงวนสิทธิ์ในการเปลี่ยนแปลงราคาโดยไม่ต้องแจ้งให้ทราบล่วงหน้า  
 Remarks : Excluded VAT 7%. The Company reserves the right to change the prices without announcement.



# “EMAUX” NSL Series

## 1.9 Inches Stainless Steel Ladders 304 for Chlorine Pool

### INSTALLATION OPTIONS



Anchor Type

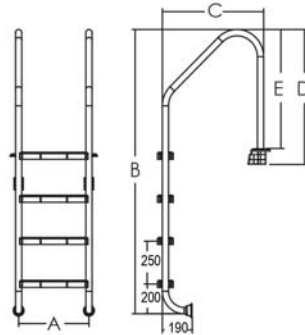

### STEP OPTIONS

#### 1. Stainless Steel



#### Anchor Type Stainless Steel Step

Code (AISI-304)	Model No.	A mm	B mm	C mm	D mm	E mm
88072601	NSL215-S	493	1320	686	788	708
88072602	NSL315-S	493	1570	686	788	708
88072603	NSL415-S	493	1820	686	788	708
88072604	NSL515-S	493	2070	686	788	708
88072613	NSL815-S	493	2830	692	699	619

#### 2. Plastic



#### Anchor Type Plastic Step

Code (AISI-304)	Model No.	A mm	B mm	C mm	D mm	E mm
88072701	NSL215-P	476	1320	686	788	708
88072702	NSL315-P	476	1570	686	788	708
88072703	NSL415-P	476	1820	686	788	708
88072704	NSL515-P	476	2070	686	788	708
88072713	NSL815-P	476	2830	692	699	619

Code	Model	Steps Material	Step Quantity	Retail Price	Code✖
21810510005	NSL215-P	Plastic Steps	2	8,700.00	H★
21810510010	NSL215-S	Stainless Steel Steps	2	9,300.00	
21810510035	NSL315-P	Plastic Steps	3	10,300.00	
21810510040	NSL315-S	Stainless Steel Steps	3	10,900.00	
21810510065	NSL415-P	Plastic Steps	4	11,500.00	
21810510070	NSL415-S	Stainless Steel Steps	4	12,600.00	
21810510095	NSL515-P	Plastic Steps	5	13,100.00	
21810510100	NSL515-S	Stainless Steel Steps	5	14,400.00	

หมายเหตุ : ราคายังไม่รวมภาษี 7% บริษัทฯ ขอสงวนสิทธิ์ในการเปลี่ยนแปลงราคาโดยไม่ต้องแจ้งให้ทราบล่วงหน้า

Remarks : Excluded VAT 7%. The Company reserves the right to change the prices without announcement.



# “EMAUX” NSF Series 1.9 Inches Stainless Steel Ladders 304 for Chlorine Pool

**INSTALLATION OPTIONS**



Anchor Type

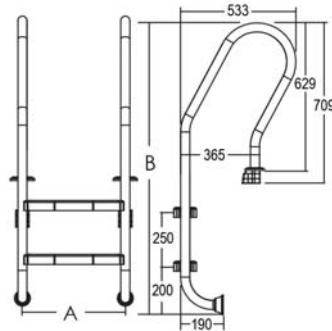

**STEP OPTIONS**

1. Stainless Steel



### Anchor Type Stainless Steel Step

Code (AISI-304)	Model No.	A mm	B mm
88072401	NSF215-S	493	1330
88072402	NSF315-S	493	1580
88072403	NSF415-S	493	1830
88072404	NSF515-S	493	2080

2. Plastic



### Anchor Type Plastic Step

Code (AISI-304)	Model No.	A mm	B mm
88072501	NSF215-P	476	1330
88072502	NSF315-P	476	1580
88072503	NSF415-P	476	1830
88072504	NSF515-P	476	2080

Code	Model	Steps Material	Step Quantity	Retail Price	Code✘
21810510105	NSF215-P	Plastic Steps	2	8,200.00	H★
21810510020	NSF215-S	Stainless Steel Steps	2	8,700.00	
21810510045	NSF315-P	Plastic Steps	3	9,300.00	
21810510050	NSF315-S	Stainless Steel Steps	3	10,300.00	
21810510075	NSF415-P	Plastic Steps	4	10,300.00	
21810510080	NSF415-S	Stainless Steel Steps	4	12,400.00	
21810510125	NSF515-P	Plastic Steps	5	11,700.00	
21810510110	NSF515-S	Stainless Steel Steps	5	13,600.00	

หมายเหตุ : ราคายังไม่รวมภาษี 7% บริษัทฯ ขอสงวนสิทธิ์ในการเปลี่ยนแปลงราคาโดยไม่ต้องแจ้งให้ทราบล่วงหน้า  
Remarks : Excluded VAT 7%. The Company reserves the right to change the prices without announcement.



# “EMAUX” NMU Series

## 1.9 Inches Stainless Steel Ladders 304 for Chlorine Pool

### INSTALLATION OPTIONS



Anchor Type

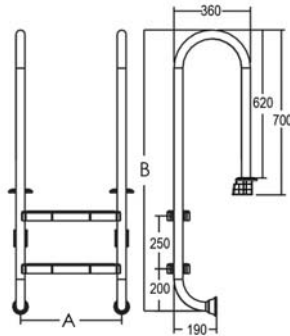

### STEP OPTIONS

#### 1. Stainless Steel



#### Anchor Type Stainless Steel Step

Code (AISI-304)	Model No.	A mm	B mm
88072801	NMU215-S	493	1330
88072802	NMU315-S	493	1580
88072803	NMU415-S	493	1830
88072804	NMU515-S	493	2080

#### 2. Plastic

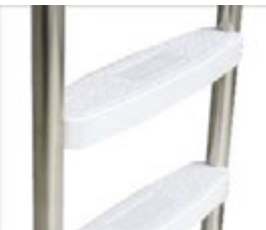

#### Anchor Type Plastic Step

Code (AISI-304)	Code (AISI-316)	Model No.	A mm	B mm
88072901	88072906	NMU215-P	476	1330
88072902	88072907	NMU315-P	476	1580
88072903	88072908	NMU415-P	476	1830
88072904	88072909	NMU515-P	476	2080

Code	Model	Steps Material	Step Quantity	Retail Price	Code✖
21810510025	NMU215-P	Plastic Steps	2	7,800.00	H★
21810510030	NMU215-S	Stainless Steel Steps	2	8,400.00	
21810510055	NMU315-P	Plastic Steps	3	8,700.00	
21810510060	NMU315-S	Stainless Steel Steps	3	10,100.00	
21810510085	NMU415-P	Plastic Steps	4	9,700.00	
21810510090	NMU415-S	Stainless Steel Steps	4	11,500.00	
21810510115	NMU515-P	Plastic Steps	5	11,000.00	
21810510120	NMU515-S	Stainless Steel Steps	5	13,200.00	

หมายเหตุ : ราคายังไม่รวมภาษี 7% บริษัทฯ ขอสงวนสิทธิ์ในการเปลี่ยนแปลงราคาโดยไม่ต้องแจ้งให้ทราบล่วงหน้า

Remarks : Excluded VAT 7%. The Company reserves the right to change the prices without announcement.



# “EMAUX” Heavy Duty Surface Skimmers (1)

The heavy-duty skimmer can be used for residential and commercial swimming pools suitable for concrete, fiberglass and vinyl surfaces. The 3 models are injection molded and made with UV resistant ABS material; the reinforced material provides the maximum strength and durability for all weather conditions. The high flexibility design allows 1.5” or 2” suction connections to the piping

### FEATURES

- Suitable for 1.5” and 2” piping
- Knockout overflow / fill part
- Durable, corrosion-proof body construction
- Large debris collection basket
- Snap-in and removable weir
- Round Shape Lid

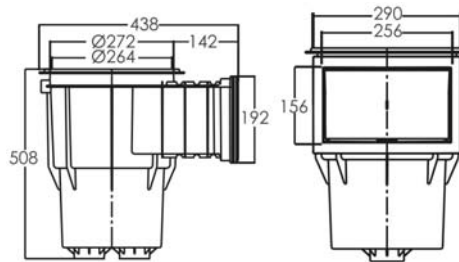

### Standard Wall Heavy Duty Skimmer (EM0030)

Code	Model	Pool Type	Pipe Connection (inches)	Retail Price	Code✖
21900510025	EM0030-RC	Concrete	2	6,000.00	H★
21900510030	EM0030-RV	Vinyl		6,600.00	

หมายเหตุ : ราคายังไม่รวมภาษี 7% บริษัทฯ ขอสงวนสิทธิ์ในการเปลี่ยนแปลงราคาโดยไม่ต้องแจ้งให้ทราบล่วงหน้า  
 Remarks : Excluded VAT 7%. The Company reserves the right to change the prices without announcement.



# “EMAUX” Heavy Duty Surface Skimmers (2)



## Wide Mouth Wall Heavy Duty Skimmer (EM0040)

Code	Model	Pool Type	Pipe Connection (inches)	Retail Price	Code✘
21900510035	EM0040-RC	Concrete	2	7,200.00	H★
21900510040	EM0040-RV	Vinyl		7,800.00	



## Heavy Duty Skimmer With Extension (EM0050)

Code	Model	Pool Type	Pipe Connection (inches)	Retail Price	Code✘
21900510045	EM0050-RC	Concrete	2	7,800.00	H★
21900510050	EM0050-RV	Vinyl		9,000.00	

หมายเหตุ : ราคายังไม่รวมภาษี 7% บริษัทฯ ขอสงวนสิทธิ์ในการเปลี่ยนแปลงราคาโดยไม่ต้องแจ้งให้ทราบล่วงหน้า  
 Remarks : Excluded VAT 7%. The Company reserves the right to change the prices without announcement.



# “EMAUX” Standard Surface Skimmers & Water Regulator

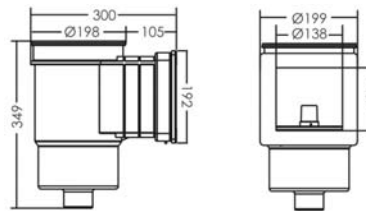

## EM0010-RC / EM0010-RV

Code	Model	Pool Type	Flow Rate (L/min)	Pipe Connection (inches)	Retail Price	Code✘
21900510005	EM0010-RC	Concrete	150	1.5	2,400.00	H★
21900510010	EM0010-RV	Vinyl	150		2,900.00	

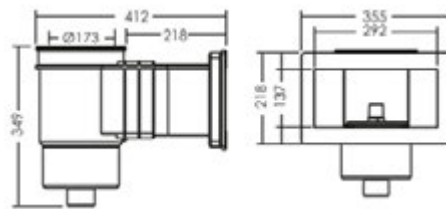

## EM0020-RC / EM0020-RV

Code	Model	Pool Type	Flow Rate (L/min)	Pipe Connection (inches)	Retail Price	Code✘
21900510015	EM0020-RC	Concrete	150	1.5	2,900.00	H★
21900510020	EM0020-RV	Vinyl	150		3,600.00	

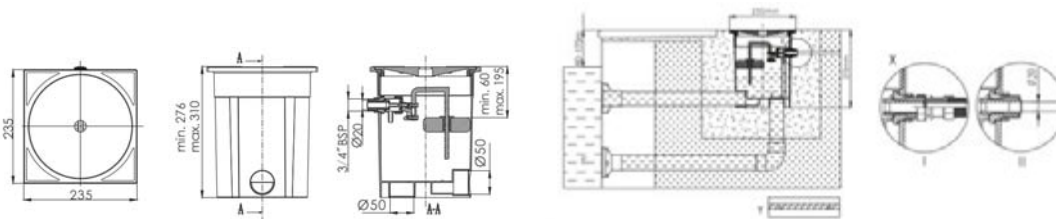

## RO-7

Code	Model	Description	Retail Price	Code✘
22900510090	RO-7	Water Regulator	2,400.00	H★

หมายเหตุ : ราคายังไม่รวมภาษี 7% บริษัทฯ ขอสงวนสิทธิ์ในการเปลี่ยนแปลงราคาโดยไม่ต้องแจ้งให้ทราบล่วงหน้า  
 Remarks : Excluded VAT 7%. The Company reserves the right to change the prices without announcement.





# “POOLSPA” Inlet & Vacuum Fittings (1) Plastic ABS Grade A With UV Stabilized

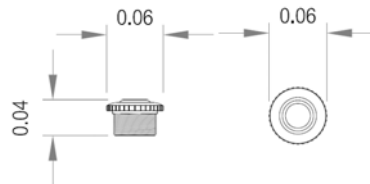

Code	Model	Description	Flow Rate (gpm)	Connection (inches)	Colour	Retail Price	Code✘
22801610005	PSF-01-W	Mini Eyeball	18	1.5	White	250.00	H★
22801610010	PSF-01-B				Black	500.00	



Code	Model	Description	Flow Rate (gpm)	Connection (inches)	Colour	Retail Price	Code✘
22801610015	PSF-02-W	Standard Eyeball	18	1.5 & 2	White	250.00	H★
22801610020	PSF-02-B				Black	500.00	



Code	Model	Description	Flow Rate (gpm)	Connection (inches)	Colour	Retail Price	Code✘
22801610025	PSF-03-W	Star Eyeball	18	1.5 & 2	White	250.00	H★
22801610030	PSF-03-B				Black	500.00	

หมายเหตุ : ราคายังไม่รวมภาษี 7% บริษัทฯ ขอสงวนสิทธิ์ในการเปลี่ยนแปลงราคาโดยไม่ต้องแจ้งให้ทราบล่วงหน้า  
Remarks : Excluded VAT 7%. The Company reserves the right to change the prices without announcement.



# “POOLSPA” Inlet & Vacuum Fittings (2) Plastic ABS Grade A With UV Stabilized



Code	Model	Description	Flow Rate (gpm)	Connection (inches)	Colour	Retail Price	Code*
22811610015	PSF-05-W	Star Vacuum	50	1.5 & 2	White	250.00	H★
22811610020	PSF-05-B				Black	500.00	



Code	Model	Description	Flow Rate (gpm)	Connection (inches)	Colour	Retail Price	Code*
22811610025	PSF-06-W	Standard Vacuum (New Model)	50	1.5 & 2	White	250.00	H★
22811610030	PSF-06-B				Black	500.00	

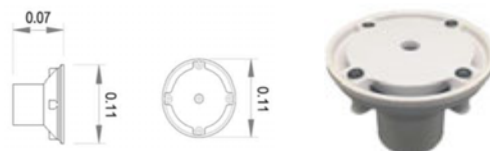

Code	Model	Description	Flow Rate (gpm)	Connection (inches)	Colour	Retail Price	Code*
22811610035	PSF-07-W	Standard Floor Inlet	50	1.5 & 2	White	290.00	H★
22811610040	PSF-07-B				Black	580.00	

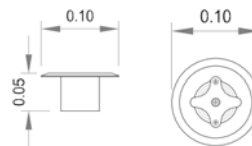

Code	Model	Description	Flow Rate (gpm)	Connection (inches)	Colour	Retail Price	Code*
22801610035	PSF-20-W	Floor Inlet	50	1.5 & 2	White	290.00	H★
22801610040	PSF-20-B				Black	580.00	

หมายเหตุ : ราคายังไม่รวมภาษี 7% บริษัทฯ ขอสงวนสิทธิ์ในการเปลี่ยนแปลงราคาโดยไม่ต้องแจ้งให้ทราบล่วงหน้า  
Remarks : Excluded VAT 7%. The Company reserves the right to change the prices without announcement.



# “EMAUX” Inlet & Vacuum Fittings (1) Plastic ABS Grade A With UV Stabilized

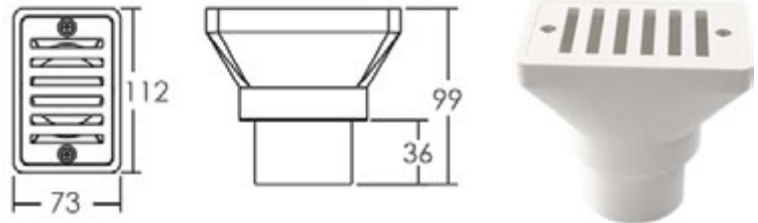

Code	Model	Description	Flow Rate (L/min)	Connection (inches)	Colour	Retail Price	Code✖
22820510005	EM2819(A2)	Gutter Drain	150 (1.5") / 235 (2.0")	1.5	White	330.00	H★

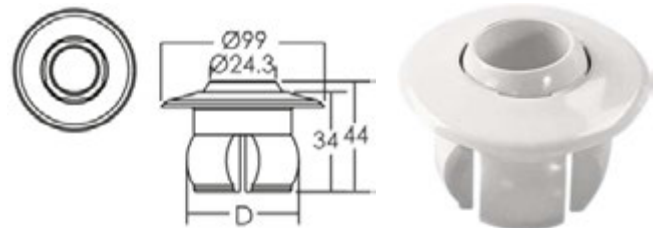

Code	Model	Description	Flow Rate (L/min)	Connection (inches)	Colour	Retail Price	Code✖
22800510005	EM3301(A1)	Standard Eyeball (Snap)	69	1.5	White	260.00	H★

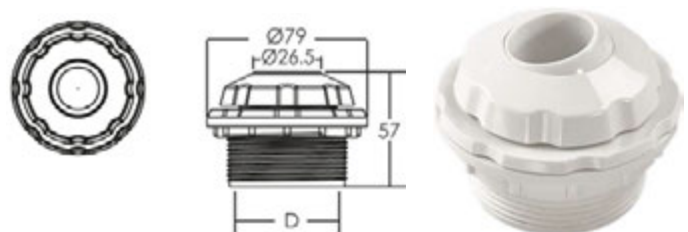

Code	Model	Description	Flow Rate (L/min)	Connection (inches)	Colour	Retail Price	Code✖
22800510010	EM3302(A)	Eyeball	69	1.5	White	330.00	H★

หมายเหตุ : ราคายังไม่รวมภาษี 7% บริษัทฯ ขอสงวนสิทธิ์ในการเปลี่ยนแปลงราคาโดยไม่ต้องแจ้งให้ทราบล่วงหน้า  
Remarks : Excluded VAT 7%. The Company reserves the right to change the prices without announcement.



## “EMAUX” Inlet & Vacuum Fittings (2) Plastic ABS Grade A With UV Stabilized

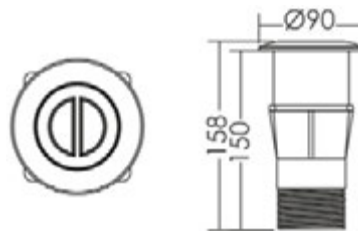

Code	Model	Description	Flow Rate (L/min)	Connection (inches)	Colour	Retail Price	Code✘
22810510005	EM2827C(A)	Vacuum for Concrete Pool	150	1.5	White	490.00	H★

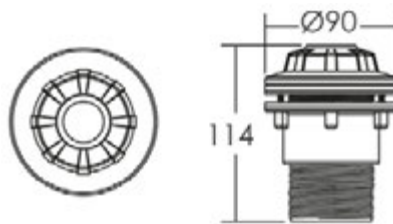

Code	Model	Description	Connection (inches)	Colour	Retail Price	Code✘
22810510010	EM2828V(A)	Eyeball for Vinyl Pool	1.5	White	670.00	H★

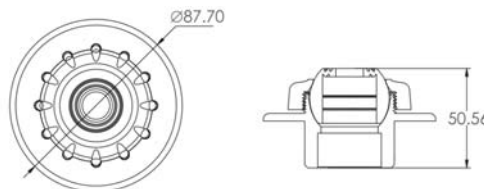

Code	Model	Description	Connection (inches)	Colour	Retail Price	Code✘
22810510015	EM4408(A)	Wall return inlet for Concrete pools. Glue type, adjustable angle. Ø 50mm	1.5	White	330.00	H★

หมายเหตุ : ราคายังไม่รวมภาษี 7% บริษัทฯ ขอสงวนสิทธิ์ในการเปลี่ยนแปลงราคาโดยไม่ต้องแจ้งให้ทราบล่วงหน้า  
Remarks : Excluded VAT 7%. The Company reserves the right to change the prices without announcement.



# “EMAUX” Inlet & Vacuum Fittings (3) Plastic ABS Grade A With UV Stabilized

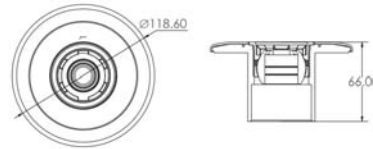

Code	Model	Description	Connection (inches)	Colour	Retail Price	Code✘
22810510020	EM4412(A)	Wall return inlet with horizontal eyeball. For Vinyl and Liner pools, G2 threaded, Ø 50	1.5	White	760.00	H★

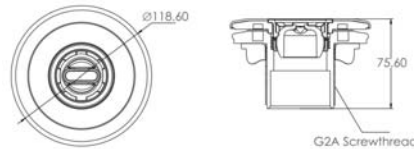

Code	Model	Description	Connection (inches)	Colour	Retail Price	Code✘
22810510025	EM4413(A)	Wall return inlet for Concrete pools, Glue type, Ø 50 or Ø63 adjustable angle.	1.5	White	330.00	H★

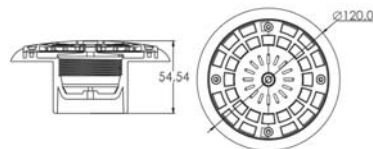

Code	Model	Description	Connection (inches)	Colour	Retail Price	Code✘
22810510030	EM2861(A)	Floor return inlet for Concrete pools, Glue type, Ø 63mm	2.0	White	490.00	H★

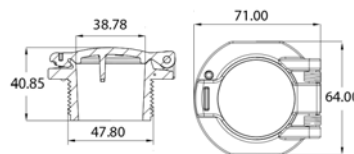

Code	Model	Description	Flow Rate (L/min)	Connection (inches)	Colour	Retail Price	Code✘
22810510035	EM2855	Vacuum Lock Safety Wall Fitting	150 - 240	1.5	White	920.00	H★

หมายเหตุ : ราคายังไม่รวมภาษี 7% บริษัทฯ ขอสงวนสิทธิ์ในการเปลี่ยนแปลงราคาโดยไม่ต้องแจ้งให้ทราบล่วงหน้า

Remarks : Excluded VAT 7%. The Company reserves the right to change the prices without announcement.



# “POOLSPA” Main Drain Fittings

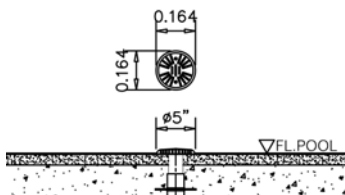

Code	Model	Description	Type	Connection (inches)	Flow Rate (gpm)	Colour	Retail Price	Code✕
22901610005	PSF-09-CW	Suction 5"	Concrete	2	150	White	970.00	H★
22901610010	PSF-09-CB					Black	1,940.00	
22901610015	PSF-09-FW		Fiberglass			White	1,800.00	
22901610020	PSF-09-FB					Black	3,600.00	



Code	Model	Description	Flow Rate (gpm)	Colour	Retail Price	Code✕
22901610025	PSF-10-W	Main drain Round 8"	180	White	420.00	H★
22901610030	PSF-10-B			Black	840.00	

Code	Model	Description	Flow Rate (gpm)	Colour	Retail Price	Code✕
22901610035	PSF-11-W	Main drain 9" x 9"	200	White	990.00	H★
22901610040	PSF-11-B			Black	1,980.00	
22901610045	PSF-12-W	Main drain 12" x 12"	300	White	1,450.00	
22901610050	PSF-12-B			Black	2,900.00	

หมายเหตุ : ราคายังไม่รวมภาษี 7% บริษัทฯ ขอสงวนสิทธิ์ในการเปลี่ยนแปลงราคาโดยไม่ต้องแจ้งให้ทราบล่วงหน้า  
 Remarks : Excluded VAT 7%. The Company reserves the right to change the prices without announcement.



# “EMAUX” Main Drain Fittings



Code	Model	Description	Flow Rate (L/min)	Connection (inches)	Colour	Retail Price	Code✖
22900510005	EM2833HC	Main Drain for Concrete pool with Hydrostatic Relief Valve & Collector Tube	240	2	White	3,600.00	H★

Code	Model	Description	Retail Price	Code✖
20330280150	89140501	Spare Part – Hydrostatic Relief Valve 2”	490.00	B

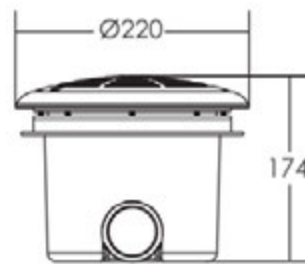

Code	Model	Description	Flow Rate (L/min)	Connection (inches)	Colour	Retail Price	Code✖
22900510010	EM2832C	Main Drain for Concrete Pool	150	1.5	White	1,600.00	H★

หมายเหตุ : ราคายังไม่รวมภาษี 7% บริษัทฯ ขอสงวนสิทธิ์ในการเปลี่ยนแปลงราคาโดยไม่ต้องแจ้งให้ทราบล่วงหน้า  
 Remarks : Excluded VAT 7%. The Company reserves the right to change the prices without announcement.



# “EMAUX” VGB Anti Vortex Main Drain, ABS

Emaux new series Main Drain comply with provision of ANSI/APSP-16 2011 standard and the Virginia Graeme Baker Pool and Spa Safety Act. High quality main drains are made in ABS has the resistance in corrosion and ultra-violet.

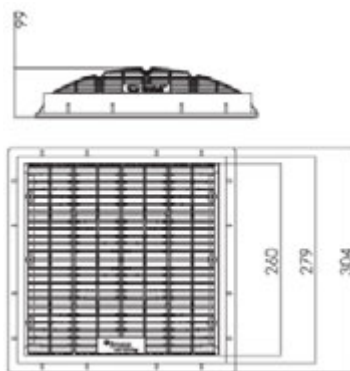

Code	Model	Description	Flow Rate (L/min)	Colour	Retail Price	Code✘
22900510025	EM2813	VGB Anti Vortex Main Drain Square 12" x 12"	900	White	4,100.00	H★

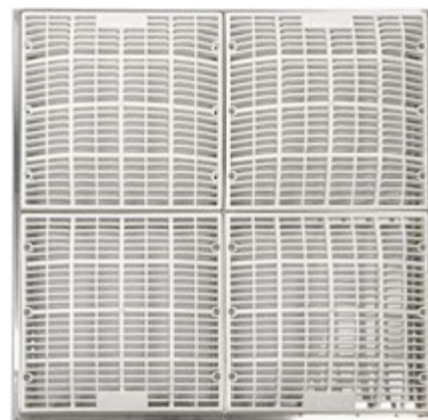
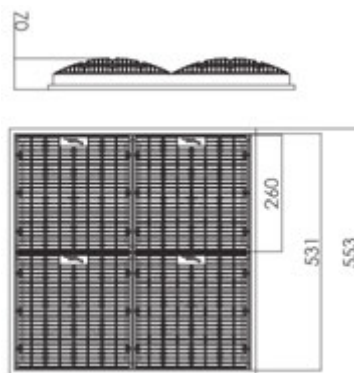

Code	Model	Description	Flow Rate (L/min)	Colour	Retail Price	Code✘
22900510030	EM2816✘	VGB Anti Vortex Main Drain Square 12" x 12" (4pcs), With Frame Stainless Steel 316, For Salt Water Pool	3600	White	19,000.00	H★

✘ สินค้าไม่มีสต็อก กรุณาสั่งล่วงหน้า 60-90 วัน / No Stock, Delivery Time 60-90 Days

หมายเหตุ : ราคายังไม่รวมภาษี 7% บริษัทฯ ขอสงวนสิทธิ์ในการเปลี่ยนแปลงราคาโดยไม่ต้องแจ้งให้ทราบล่วงหน้า  
 Remarks : Excluded VAT 7%. The Company reserves the right to change the prices without announcement.





**“POOLSPA” Spa Jets Fittings**  
**Plastic ABS Grade A With UV Stabilized**



Code	Model	Description	Flow Rate (gpm)	Connection (inches)	Colour	Retail Price	Code✕
23031610040	PSF-02+PSJ-01	Long Venturi Tee Spa Jet Set For Concrete Pool	18 - 25	1.5	White	1,300.00	H★

Code	Model	Description	Flow Rate (gpm)	Connection (inches)	Colour	Retail Price	Code✕
23031610045	PSF-02+PSJ-02	Short Spa Jet Set For Concrete Pool	18 - 25	1.5	White	990.00	H★

หมายเหตุ : ราคายังไม่รวมภาษี 7% บริษัทฯ ขอสงวนสิทธิ์ในการเปลี่ยนแปลงราคาโดยไม่ต้องแจ้งให้ทราบล่วงหน้า  
 Remarks : Excluded VAT 7%. The Company reserves the right to change the prices without announcement.



# “EMAUX” Spa Jet Fittings (1)

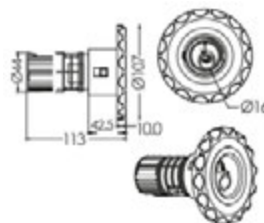

Code	Model	Description	Flow Rate (L/min)	Colour	Retail Price	Code✘
23010510005	EM0018	Face (Swirl Jet)	17	White	500.00	H★

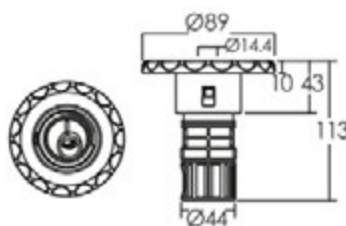

Code	Model	Description	Flow Rate (L/min)	Colour	Retail Price	Code✘
23010510010	EM0028	Face (Swirl Jet)	17	White	500.00	H★

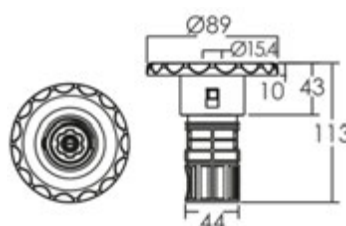

Code	Model	Description	Flow Rate (L/min)	Colour	Retail Price	Code✘
23010510060	EM0034	Face (Standard Jet)	17	White	500.00	H★

หมายเหตุ : ราคายังไม่รวมภาษี 7% บริษัทฯ ขอสงวนสิทธิ์ในการเปลี่ยนแปลงราคาโดยไม่ต้องแจ้งให้ทราบล่วงหน้า  
 Remarks : Excluded VAT 7%. The Company reserves the right to change the prices without announcement.



# “EMAUX” Spa Jet Fittings (2)

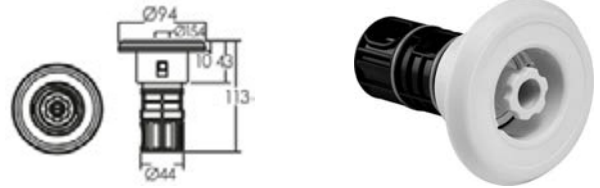

Code	Model	Description	Flow Rate (L/min)	Colour	Retail Price	Code✘
23010510020	EM0044	Smooth Face (Standard Jet)	17	White	500.00	H★

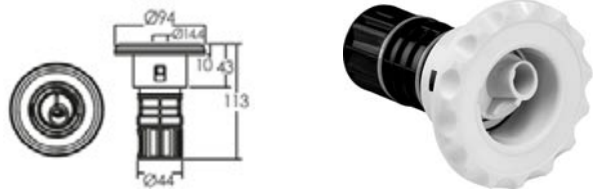

Code	Model	Description	Flow Rate (L/min)	Colour	Retail Price	Code✘
23010510025	EM0048	Smooth Face (Swirl Jet)	17	White	500.00	H★

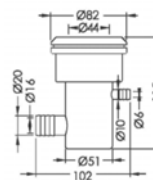

Code	Model	Description	Flow Rate (L/min)	Colour	Retail Price	Code✘
23020510005	EM0021	Φ10mm Barb Air & Φ20mm Barb Water, Ell Body	53	White	500.00	H★

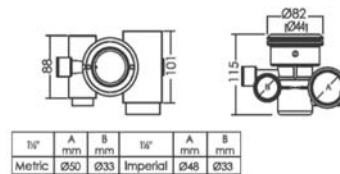

Code	Model	Description	Flow Rate (L/min)	Colour	Retail Price	Code✘
23020510010	EM0031	Φ25mm Air & Φ40mm Water Tee Body	76	White	500.00	H★

หมายเหตุ : ราคายังไม่รวมภาษี 7% บริษัทฯ ขอสงวนสิทธิ์ในการเปลี่ยนแปลงราคาโดยไม่ต้องแจ้งให้ทราบล่วงหน้า  
 Remarks : Excluded VAT 7%. The Company reserves the right to change the prices without announcement.



# “EMAUX” Spa Jet Fittings (3)

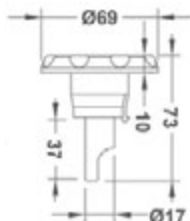

Code	Model	Description	Connection (inches)	Flow Rate (L/min)	Colour	Retail Price	Code✕
23020510015	EM1113	Φ2-3/4" Face Eyeball Spa Jet	-	17	White	230.00	H★

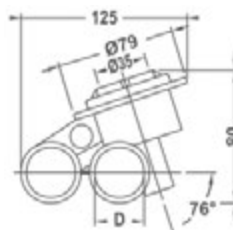

Code	Model	Description	Connection (inches)	Flow Rate (L/min)	Colour	Retail Price	Code✕
23020510025	EM1138	Φ25mm Air & Φ25mm Water Tee Body	1	52	White	420.00	H★

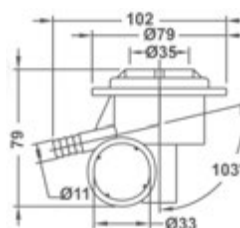

Code	Model	Description	Connection (inches)	Flow Rate (L/min)	Colour	Retail Price	Code✕
23020510030	EM1148	Φ10mm Barb Air & Φ25mm Water Tee Body	1	52	White	420.00	H★

หมายเหตุ : ราคายังไม่รวมภาษี 7% บริษัทฯ ขอสงวนสิทธิ์ในการเปลี่ยนแปลงราคาโดยไม่ต้องแจ้งให้ทราบล่วงหน้า  
 Remarks : Excluded VAT 7%. The Company reserves the right to change the prices without announcement.



# “EMAUX” Floor Bubbles Fittings

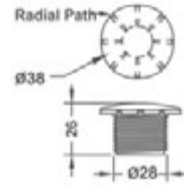

Code	Model	Description	Flow Rate (L/min)	Connection (inches)	Colour	Retail Price	Code✘
23030510005	EM2209	Φ1 1/2" Face (Radial Air Jet)	2.5	3/4	White	160.00	H★



Code	Model	Description	Flow Rate (L/min)	Connection (inches)	Colour	Retail Price	Code✘
23030510010	EM2210	Φ2 1/4" Face (Arc Jet)	8.6	3/4	White	160.00	H★

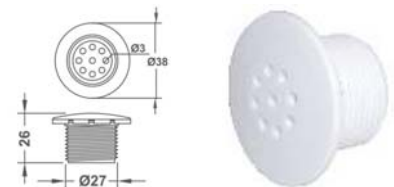

Code	Model	Description	Flow Rate (L/min)	Connection (inches)	Colour	Retail Price	Code✘
23030510015	EM2211	Round Floor Bubble 9 holes	5.7	3/4	White	160.00	H★



Code	Model	Description	Flow Rate (L/min)	Connection (inches)	Colour	Retail Price	Code✘
23030610160	EM2202B	L-Type Body Φ15mm Water Inlet	5.7	3/4	White	330.00	H★

หมายเหตุ : ราคายังไม่รวมภาษี 7% บริษัทฯ ขอสงวนสิทธิ์ในการเปลี่ยนแปลงราคาโดยไม่ต้องแจ้งให้ทราบล่วงหน้า  
 Remarks : Excluded VAT 7%. The Company reserves the right to change the prices without announcement.



# “POOLSPA” Floor Bubble Fittings

## Plastic ABS Grade A

### With UV Stabilized

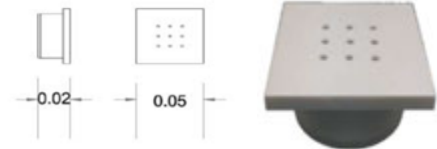

Code	Model	Description	Flow Rate (gpm)	Connection (inches)	Colour	Retail Price	Code✘
23031610025	PSF-15-W	Square Floor Bubble 9 holes	10 - 15	1	White	230.00	H★
23031610030	PSF-15-B				Black	460.00	

# “POOLSPA” Air Valve Control Fittings

## Plastic ABS Grade A With UV Stabilized

Code	Model	Description	Connection (inches)	Colour	Retail Price	Code✘
23041610005	PSF-13-W	Mini Air Valve Control (Snap)	1	White	390.00	H★
23041610035	PSF-13-B			Black	780.00	



Code	Model	Description	Connection (inches)	Colour	Retail Price	Code✘
23041610020	PSF-14-W	Standard Air Valve Control	1.5	White	560.00	H★
23041610025	PSF-14-B			Black	1,120.00	

หมายเหตุ : ราคายังไม่รวมภาษี 7% บริษัทฯ ขอสงวนสิทธิ์ในการเปลี่ยนแปลงราคาโดยไม่ต้องแจ้งให้ทราบล่วงหน้า  
 Remarks : Excluded VAT 7%. The Company reserves the right to change the prices without announcement.



# “EMAUX” Air Valve Control Fittings

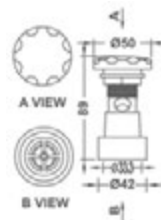

Code	Model	Description	Connection (inches)	Colour	Retail Price	Code✕
23041610010	EM1834	Air Valve Control	1	White	290.00	H★

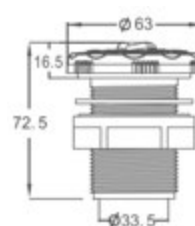

Code	Model	Description	Connection (inches)	Colour	Retail Price	Code✕
23041610030	EM1835	Standard Air Valve Control	1.5	White	420.00	H★

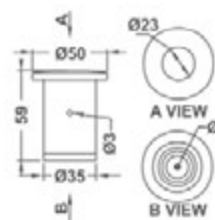

Code	Model	Description	Connection (inches)	Colour	Retail Price	Code✕
23041610015	EM1844	Air Button	1	White	260.00	H★

หมายเหตุ : ราคายังไม่รวมภาษี 7% บริษัทฯ ขอสงวนสิทธิ์ในการเปลี่ยนแปลงราคาโดยไม่ต้องแจ้งให้ทราบล่วงหน้า  
 Remarks : Excluded VAT 7%. The Company reserves the right to change the prices without announcement.



# “EMAUX” Suction Drain Fittings

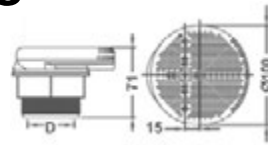

Code	Model	Description	Connection (inches)	Colour	Retail Price	Code✖
22900510035	EM3811	Suction Drain Lock Nut	1.5	White	810.00	H★

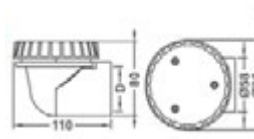

Code	Model	Description	Connection (inches)	Colour	Retail Price	Code✖
22900510040	EM3822(A)	Suction Drain Ell	1.5	White	810.00	H★

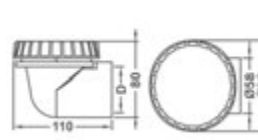

Code	Model	Description	Connection (inches)	Colour	Retail Price	Code✖
22900510045	EM3822(B)	Suction Drain Ell Body	1.5	White	810.00	H★

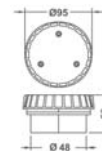

Code	Model	Description	Connection (inches)	Colour	Retail Price	Code✖
22900510050	EM3833(A)	Suction Drain Straight Body (with bolt)	1.5	White	810.00	H★

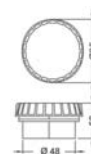

Code	Model	Description	Connection (inches)	Colour	Retail Price	Code✖
22900510055	EM3833(B)	Suction Drain Straight Body	1.5	White	810.00	H★



Code	Model	Description	Connection (inches)	Colour	Retail Price	Code✖
22900510060	EM3844	Suction Drain	1.5	White	960.00	H★

หมายเหตุ : ราคายังไม่รวมภาษี 7% บริษัทฯ ขอสงวนสิทธิ์ในการเปลี่ยนแปลงราคาโดยไม่ต้องแจ้งให้ทราบล่วงหน้า  
 Remarks : Excluded VAT 7%. The Company reserves the right to change the prices without announcement.





# “TECMARK” Air Switches

## Made In USA

### SERIES MPT TRANSMITTERS

are an essential component in Tecmark's pneumatic switching technology, LlectricAir®, which safely isolates the user from the electrical current. The Series M and Series MPT air transmitters provide the pulse air pressure needed to operate a remote air switch. The compact and efficient features of these transmitters are designed for hand actuation and can operate Tecmark® component switches from distances of up to 100 feet.

Superior quality construction makes Series M and Series MPT transmitters suitable for environments up to 200° F. Series M and Series MPT transmitters incorporate EPDM bellows material which is impervious to ozone and ideal for use around chemically treated water. Their mechanical life expectancy far exceeds industry acceptable standards. Series M and Series MPT transmitters feature interchangeable metal or plastic buttons & bezels and are available in a large variety of colors and finishes (consult factory).

### TYPICAL APPLICATIONS

Series M and Series MPT transmitters provide the air pressure needed to activate remote air switches which turn a variety of electrical devices on/off including motors, lights, pumps, air blowers, or other associated equipment.



Series MPT Air Transmitter



Series TBS300 Air Switch

Code	Model	Description	Retail Price	Code✘
2020090010	AS-01	Residential Air Switch Button Complete Set	3,900.00	H★
2020090060	AS-02	Commercial Air Switch Button Complete Set	6,900.00	
2020090005	AS-03	Residential Air Switch Button Complete Set with Stainless Steel Covered	5,500.00	H★
2330610151	MPT-01010-3428	Residential Air Switch Button	1,100.00	H★
2330610150-06	MPT-01010-3242	Commercial Air Switch Button	3,200.00	
23032010035	TBS310A	Contact Air Switch	1,520.00	H★
23032010050	20236BM	Air Actuator	320.00	H★
2100572545	AS-08	Air Switch Box Complete with Seal	1,600.00	H★
2020090030	AS-09	Air Tube / Price Per Meter	490.00	H★



หมายเหตุ : ราคายังไม่รวมภาษี 7% บริษัทฯ ขอสงวนสิทธิ์ในการเปลี่ยนแปลงราคาโดยไม่ต้องแจ้งให้ทราบล่วงหน้า  
 Remarks : Excluded VAT 7%. The Company reserves the right to change the prices without announcement.



## “POOLSPA” Control Box & Remote Set For Spa Pump



Code	Model	Description	Retail Price	Code✘
2516070101	PS-CB-AS-01	Controller & Remote Set for Jacuzzi Spa, With 10 Amp Relay Supply Lead & Plug	17,500.00	B
2516070105	PS-CB-Remote	Remote	1,200.00	



## “FLUVO” Pressure Sensitive Switch S-Touch Made In German



**Advation options: hydro-massage at the touch of a button**

Depending on the nozzle concept, select your activation option. It is up to the designer or client, at which location in the pool the activation option is placed.

Code	Model	Description	Retail Price	Code✘
23030600005	98787✘	Assembly Kit Sensory Touch Key Round	46,500.00	B
23030600010	98843✘	Assembly Kit Sensory Touch Key Illuminated Round	54,000.00	

✘ สินค้าไม่มีสต็อก กรุณาลงสั่งซื้อล่วงหน้า / No Stock, Delivery Time : 30 - 60 Days

หมายเหตุ : ราคายังไม่รวมภาษี 7% บริษัทฯ ขอสงวนสิทธิ์ในการเปลี่ยนแปลงราคาโดยไม่ต้องแจ้งให้ทราบล่วงหน้า  
Remarks : Excluded VAT 7%. The Company reserves the right to change the prices without announcement.

# UW SPEAKER





# UW30 Series Underwater Loudspeakers

The UW30 represents a departure in the design of underwater sound sources. Its unique design U.S. Patent #3,670,299, utilizes the case's structural enclosure as the sound transducer. This development makes possible a speaker that has no metal parts exposed to the outside, thus eliminating rust, corrosion or other causes of short-life expectancy. The transducer principle and its strong construction allow the UW30 to operate at much greater depths than any prior type of underwater loudspeaker design. The 12.7-punce ceramic magnet and stage-of-the-art voice coil construction ensure full-fidelity response with the lowest possible distortion throughout its power range.

The UW30 is equipped with a waterproof, 3 conductor 15.24m (50ft) cable.

The UW30 underwater loudspeaker is designed for permanent installation and completely submerged operation. All internal components are encapsulated with a "hot-melt" (Polyamide Copolymer) process. The outer case is constructed of high impact ABS plastic, ideal for installation in both fresh and saltwater pools, the UW30 can even be installed in ocean environments without adverse effect. Problem such as corrosion and electrolysis damage inherent in all or partial metal underwater speakers are completely eliminated by the plastic construction of the UW30.

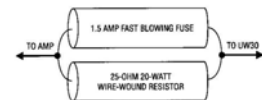

## Specifications:

**Versions Available:**

UW30 ..... 50 feet of cable (15.24 m)  
 System Type: ..... Underwater loudspeaker system  
 Frequency Response: ..... 100-10,000 Hz  
 Power Handling, (500-5,000 Hz pink noise): ..... 30 watts  
 Impedance: ..... Nominal: 8 ohms  
 Dispersion: ..... Omnidirectional underwater

Operating Depth: ..... Up to 3.0 m (10.0 ft) below surface of water  
 Recommended Installation Depth: ..... 1.2 m (4.0 ft)  
 Finish: ..... Pool blue  
**Dimensions,**  
 Overall Diameter: ..... 182.6 mm (7.19 in.)  
 Depth: ..... 66.3 mm (2.61 in.)  
 Shipping Weight: ..... 1.8 kg (4.0 lb)

Code	Model	Description	Retail Price	Code✕
21653100005	UW 30✕	Cable 15 meters Complete set with Niches & Faceplate	กรุณาติดต่อเจ้าหน้าที่ / Please Check with Sales Assistance	

หมายเหตุ : ราคายังไม่รวมภาษี 7% บริษัทฯ ขอสงวนสิทธิ์ในการเปลี่ยนแปลงราคาโดยไม่ต้องแจ้งให้ทราบล่วงหน้า  
 Remarks : Excluded VAT 7%. The Company reserves the right to change the prices without announcement.

A large, rectangular swimming pool with clear blue water, surrounded by a wooden deck. In the foreground, a young boy and a young girl are sitting on the edge of the pool, looking towards the water. The boy is wearing a white tank top and blue shorts, and the girl is wearing a yellow dress. A slice of watermelon is visible on the deck in front of them. The background shows a fence and some trees.

# SAFETY SYSTEM



# “VAC-ALERT” Safety Vacuum Release System

A Safety Vacuum Release System – or SVRS for short – is an automatic suction force release system. When a drain becomes blocked, the SVRS provides a rapid vacuum release. This quickly frees anyone whose body or limb is trapped on the drain.

### SVRS: Safety Vacuum Release System

- Self-monitoring, non-electrical and low maintenance
- Easy to install within thirty minutes
- Long lasting design features moisture resistant PVC and stainless steel construction
- Simple adjustment and manual reset
- Meets all requirements of International Code Council
- Won't damage your pump when tripped



The SVRS is mounted in the main drain suction line, close to the circulation pump.

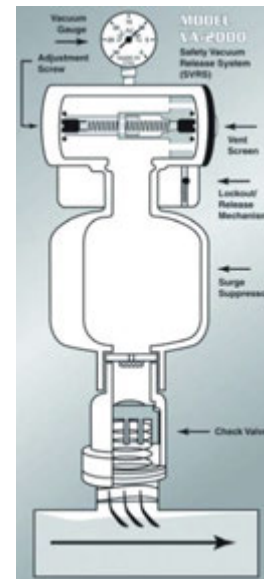

Code	Model	Description	Retail Price	Code✘
22502200005	VA-S2000S ✘	Safety Vacuum Release System (SVRS)	กรุณาติดต่อเจ้าหน้าที่ / Please Check with Sales Assistance	

✘ สินค้าไม่มีสต็อก กรุณาสั่งซื้อล่วงหน้า / No Stock, Delivery Time : 30 - 60 Days

หมายเหตุ : ราคายังไม่รวมภาษี 7% บริษัทฯ ขอสงวนสิทธิ์ในการเปลี่ยนแปลงราคาโดยไม่ต้องแจ้งให้ทราบล่วงหน้า  
Remarks : Excluded VAT 7%. The Company reserves the right to change the prices without announcement.



# VALVES







# “PREAQUA” True Union Ball Valves

Health regulations: the material is conform to the EG-VCM safety regulations

### CHARACTERISTICS

- Optimal flow rate characteristics because of non-reduced alleyway
- High durability because of ball seating ring made of PTFE or PE
- Low weight
- Radial installation or removal
- Double shaft sealing
- Made of UV resistant, corrosion free, PVC-U material

### APPLICATIONS

- Private and public pools and water treatment industry
- Swimming ponds and fish farming
- Water irrigation and cooling towers
- trick fountains

Operating temperature: Max. 60°C



Cv value table

Pressure loss	DN10	DN15	DN20	DN25	DN32	DN40	DN50	DN65	DN80
0,001 bar	4,1	6,3	13,3	20,5	28,4	44,2	82,2	143,8	212,5
1 bar	130	200	420	650	900	1400	2000	4550	6720

Code	Model	Description	Size (Inches)	Retail Price	Code✘
22101600005	125472	True Union Ball Valve - Ball Valve S6 2W PVC gray PVC-U Solvent socket ends ASTM PN16 EPDM PE lose packed	1.5"	1,050.00	B ★
22101600020	125473		2"	1,290.00	
22101600035	129015		2.5"	5,290.00	

### Handle For True Union Ball Valves

Code	Model	Description	Size (Inches)	Retail Price	Code✘
22101600040	100052B	Orange Handle for True Union Ball Valve - S6 2W	1.5"	530.00	B ★
22101600045	101170B		2"	530.00	

หมายเหตุ : ราคายังไม่รวมภาษี 7% บริษัทฯ ขอสงวนสิทธิ์ในการเปลี่ยนแปลงราคาโดยไม่ต้องแจ้งให้ทราบล่วงหน้า  
 Remarks : Excluded VAT 7%. The Company reserves the right to change the prices without announcement.



# “PREAQUA” Cone Spring Check Valves

## CHARACTERISTICS

- Operation pressure: 0.06 bar
- Operation temperature max. 60C
- Corrosion – resistant
- Long life-cycling
- Maintenance free
- Compact design
- Radial installation and dismantling
- Quick and precise opening and closure
- Low noise
- V4A spring



Code	Model	Description	Size (Inches)	Retail Price	Code✳
22101600010	126404	Cone Check Valve S6 DN40 PVC gray PVC-U solvent socket ends	1.5"	1,290.00	B ★
22101600025	126405		2"	1,650.00	
22101600050	121899		2.5"	8,990.00	
22101600055	121080		3"	11,880.00	

หมายเหตุ : ราคายังไม่รวมภาษี 7% บริษัทฯ ขอสงวนสิทธิ์ในการเปลี่ยนแปลงราคาโดยไม่ต้องแจ้งให้ทราบล่วงหน้า  
 Remarks : Excluded VAT 7%. The Company reserves the right to change the prices without announcement.



# “EMAUX” Sacrificial Anode Shield

## COMBINATION OF PREVENT ELECTROLYTIC CORROSION OF POOL METAL

The shield is built in Zinc Sacrificial Anode that protects the bather from electric shock risk, especially in the fiberglass pool without metal bonding. Also, it prevents electrolytic corrosion of pool metal parts when saltwater chlorinator disinfection system is applied, such as stainless steel ladder, heat pump heat exchanger, UV-C stainless steel casing, lighting stainless steel niche, pump motor aluminum housing, and salt chlorinator titanium cell plates.

### FEATURES

- Easy installation inline design add to existing 63mm / 2” Piping System
- Excellent prevent electric shock protection to fiberglass pool
- Max. 4 Bar working pressure
- Long life cycle pure zinc alloy
- 1 m 8 AWG solid copper wire and transparent lid cover for observation

### TYPICAL INSTALLATION AND LOCATION

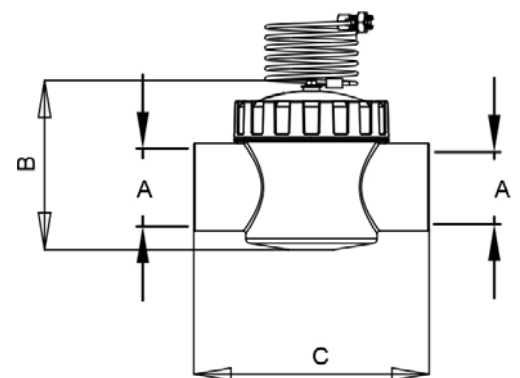

Model	Housing Material	A (mm)	B (mm)	C (mm)
DF50-1(E)	ABS & PVC	φ63	129	190
DF50-1(A)	ABS & PVC	φ60	129	190

Code	Model	Description	Size (Inches)	Retail Price	Code✘
22100510035	DF50-1	Sacrificial Anode Shield	2”	3,300.00	B★

หมายเหตุ : ราคายังไม่รวมภาษี 7% บริษัทฯ ขอสงวนสิทธิ์ในการเปลี่ยนแปลงราคาโดยไม่ต้องแจ้งให้ทราบล่วงหน้า  
 Remarks : Excluded VAT 7%. The Company reserves the right to change the prices without announcement.



# “EMAUX” 2 & 3 Way Valves

## FEATURES

- Made of durable ABS and PVC
- Large handle for easy adjustment
- Extremely reliable and maintenance free
- Max. 4 bar working pressure
- Able to withstand extreme chemical and temperature fluctuations
- Suitable for 1.5” or 2” PVC pipe

Model	Material	Connection	A (mm)	B (mm)	C (mm)
V40-1(A)	ABS & PVC	1.5"	Ø48	115	164
V50-1(A)	ABS & PVC	2"	Ø60	129	190

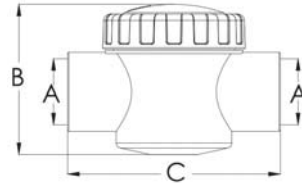

## Check Valves

Code	Model	Description	Size (Inches)	Retail Price	Code✘
22100510025	V40-1 (A)	Check Valve Clear Lid, ABS & PVC	1.5"	720.00	B★
22100510030	V50-1 (A)		2"	850.00	

Model	Material	Connection	A (mm)	B (mm)	C (mm)
V40-2(A)	ABS & PVC	1.5"	Ø48	149	164
V50-2(A)	ABS & PVC	2"	Ø60	161	190

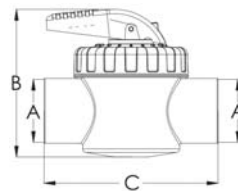

## 2-Way Valves

Code	Model	Description	Size (Inches)	Retail Price	Code✘
22100510005	V40-2 (A)	2-Way Valve, ABS & PVC	1.5"	800.00	B★
22100510015	V50-2 (A)		2"	1,050.00	

Model	Material	Connection	A (mm)	B (mm)	C (mm)
V40-3(A)	ABS & PVC	1.5"	Ø48	149	164
V50-3(A)	ABS & PVC	2"	Ø60	161	190

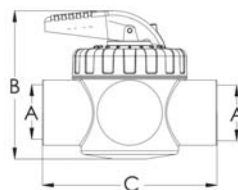

## 3-Way Valves

Code	Model	Description	Size (Inches)	Retail Price	Code✘
22100510010	V40-3 (A)	3-Way Valve, ABS & PVC	1.5"	850.00	B★
22100510020	V50-3 (A)		2"	1,100.00	

หมายเหตุ : ราคายังไม่รวมภาษี 7% บริษัทฯ ขอสงวนสิทธิ์ในการเปลี่ยนแปลงราคาโดยไม่ต้องแจ้งให้ทราบล่วงหน้า  
 Remarks : Excluded VAT 7%. The Company reserves the right to change the prices without announcement.



## Check Valves Clear Lid

Code	Model	Description	Size (Inches)	Retail Price	Code✂
22101610005	PSV-01	Check Valve Clear	1.5"	990.00	B★
22101610010	PSV-02	Lid	2"	1,100.00	

## Spring Inline Check Valves

Code	Model	Description	Size (Inches)	Retail Price	Code✂
22103100015	TW-CV-1.5	Spring Inline Check	1.5"	750.00	B★
22103100035	TW-CV-2	Valve	2"	850.00	

## Spring Inline Foot Valves

Code	Model	Description	Size (Inches)	Retail Price	Code✂
22103100020	TW-FV-1.5	Spring Inline Foot	1.5"	850.00	B★
22103100040	TW-FV-2	Valve	2"	980.00	

หมายเหตุ : ราคายังไม่รวมภาษี 7% บริษัทฯ ขอสงวนสิทธิ์ในการเปลี่ยนแปลงราคาโดยไม่ต้องแจ้งให้ทราบล่วงหน้า

Remarks : Excluded VAT 7%. The Company reserves the right to change the prices without announcement.



## True Union Ball Valves

Code	Model	Description	Size (Inches)	Retail Price	Code✳
22103100085	FM10-1	True Union Ball Valves	1"	390.00	B ★
22103100005	FM10-1.5		1.5"	820.00	
22103100025	FM10-2		2"	990.00	
22103100075	FM10-2.5		2.5"	2,300.00	
22103100090	FM10-3		3"	3,900.00	



## Swing Foot Valves

Code	Model	Description	Size (Inches)	Retail Price	Code✳
22103100080	FM14-2.5	Swing Foot Valves	2.5"	1,900.00	B ★
22103100065	FM14-3		3"	2,400.00	
22103100070	FM14-4		4"	3,300.00	



## Butterfly Valve Complete Set With Flanges

Code	Model	Description	Size (Inches)	Retail Price	Code✳
22103100045	BV-3	Butter Fly Valve Complete Set With Flanges, Galvanized Screws & Nuts and Gaskets	3"	3,500.00	B ★
22103100050	BV-4		4"	4,400.00	
22103100055	BV-6		6"	7,400.00	
22103100060	BV-8		8"	10,600.00	

## Float Valves



Code	Model	Description	Size (Inches)	Retail Price	Code✳
2756060060	FV-1	Float Valves	1"	1,300.00	Z
2756060080	FV-1.5		1.5"	1,900.00	
2756060100	FV-2		2"	2,900.00	

หมายเหตุ : ราคายังไม่รวมภาษี 7% บริษัทฯ ขอสงวนสิทธิ์ในการเปลี่ยนแปลงราคาโดยไม่ต้องแจ้งให้ทราบล่วงหน้า  
Remarks : Excluded VAT 7%. The Company reserves the right to change the prices without announcement.

# INSTALLATION EQUIPMENTS



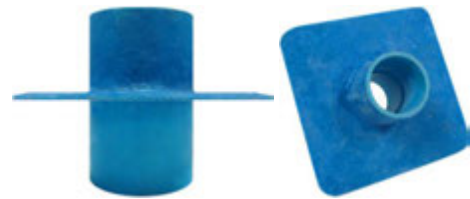

## Flashing Fittings

Code	Model	Description	Pipe Connection (inches)	Retail Price	Code✖
23111610005	F-05	ข้อต่อบีกันรั้ว Flashing	1/2"	170.00	A ★
23111610010	F-075		3/4"	260.00	
23111610015	F-10		1"	350.00	
23111610020	F-15		1.5"	540.00	
23111610025	F-20		2"	740.00	
23111610030	F-25		2.5"	870.00	
23111610035	F-30		3"	920.00	
23111610040	F-40		4"	1,490.00	
23111610045	F-60		6"	1,850.00	

## Pump Based



Code	Model	Description	Dimension	Retail Price	Code✖
20851610005	PB-01	ฐานปั๊ม Pump Based for Emaux, Hayward, Jacuzzi Pump Size 1HP-3HP	30 x 56 x 10 cm	2,700.00	A ★

## Fiber Glass Supports

Code	Model	Dimension	Retail Price	Code✖
22211610005	SP-03	3 inches X 1 meter	1,490.00	A ★
22211610010	SP-04	4 inches X 1 meter	1,990.00	

หมายเหตุ : ราคายังไม่รวมภาษี 7% บริษัทฯ ขอสงวนสิทธิ์ในการเปลี่ยนแปลงราคาโดยไม่ต้องแจ้งให้ทราบล่วงหน้า  
Remarks : Excluded VAT 7%. The Company reserves the right to change the prices without announcement.





# ROBOT POOL CLEANERS





# “DOLPHIN” Automatic Robot Pool Cleaners



## Discover an Exceptional Experience



### Powerful performance

Total cleaning and optimized water filtration, with gyroscopic navigation system for full cleaning coverage.



### Ease of use

The easiest, most efficient and economical solution for keeping your pool clean.



### Peace of mind

Relax and enjoy your pool, knowing that you're using the smartest and best-selling robotic pool cleaner.



### Energy Saving

Energy efficient solution, that provides more savings for both your utility bills and the environment.



## “DOLPHIN” Robotic Pool Cleaner Classic Caddy Cover

Code	Model	Description	Retail Price	Code✖
22400400005	Dolphin Cover	“DOLPHIN” Robotic Pool Cleaner Classic Caddy Cover	3,200.00	A

หมายเหตุ : ราคายังไม่รวมภาษี 7% บริษัทฯ ขอสงวนสิทธิ์ในการเปลี่ยนแปลงราคาโดยไม่ต้องแจ้งให้ทราบล่วงหน้า  
 Remarks : Excluded VAT 7%. The Company reserves the right to change the prices without announcement.



# “DOLPHIN” S Series Automatic Robot Pool Cleaners For Residential Pools

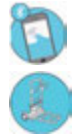

Code	22300400005	22300400010	22300400015
Model	<b>S100</b>	<b>S200</b>	<b>S300 i</b>
Retail Price	34,000.00	46,000.00	59,000.00
Code✳	A★		
Cleaning Coverage ครอบคลุมพื้นที่ทำความสะอาด เหมาะกับขนาดสระพื้นผิว	Floor / Walls / Waterline พื้น / ผนัง / ผนังที่ระดับผิวน้ำ ไลน์เนอร์, ไฟเบอร์, กระเบื้อง, Beadcrete		
Idea Pool Length เหมาะกับขนาดสระ ความยาวไม่เกิน	Up to 12 meters	Up to 15 meters	Up to 15 meters
Cable Length ความยาวของสายไฟ	15 meters	18 meters	18 meters
Filtration ระบบกรอง	Ultra-fine Basket ตะกร้ากรองตะกอนละเอียด	Ultra-fine and rough debris ตะกร้ากรองตะกอนละเอียดและตะกอนหยาบ	Multi-Layer filter for ultra-fine and rough debris ระบบกรองหลายชั้นสำหรับตะกอนหยาบและ ตะกอนละเอียด
Cleaning Options ฟังก์ชันการทำความสะอาด	Standard มาตรฐาน	Standard มาตรฐาน	Fast/Standard & Ultra เร็ว / มาตรฐาน และละเอียด
Cleaning Cycle เวลาทำความสะอาดต่อรอบ	2 hours	2 hours	1.5 / 2 / 2.5 hours
Weekly Timer ตั้งเวลาทำงานล่วงหน้าเป็น อาทิตย์	No	No	Yes
Operation Delay ตั้งเวลาล่วงหน้า	No	No	Yes
Caddy รถเข็น	No	No	Yes
Smartphone MyDolphin™ App control สั่งงานผ่านแอปบนมือถือ	No	No	Yes
LED Indicator Light ไฟแสดงการทำงานแบบแอลอีดี	No	No	Yes
Swivel ระบบป้องกันสายพันกัน	No	Yes	Yes
Carton weight น้ำหนัก	11.4 kgs.	14 kgs.	20 kgs.
Warranty รับประกัน	24 months (Limited)	24 months (Limited)	24 months (Limited)
Suction Rate แรงดูด	3,735 Gal/hr (14 m <sup>3</sup> /hr)	3,735 Gal/hr (14 m <sup>3</sup> /hr)	3,735 Gal/hr (14 m <sup>3</sup> /hr)

หมายเหตุ : ราคายังไม่รวมภาษี 7% บริษัทฯ ขอสงวนสิทธิ์ในการเปลี่ยนแปลงราคาโดยไม่ต้องแจ้งให้ทราบล่วงหน้า  
Remarks : Excluded VAT 7%. The Company reserves the right to change the prices without announcement.



# “DOLPHIN” M Series

## Automatic Robot Pool Cleaners For Semi-Commercial Pools



Code	22300400020	22300400025	22300400070	22300400080
Model	<b>M400</b>	<b>M500</b>	<b>M600</b>	<b>M700</b>
Retail Price	66,000.00	79,000.00	89,000.00	119,000.00
Code✖	A★			
Cleaning Coverage ครอบคลุมพื้นที่ทำความสะอาด สะอาด	Floor / Walls / Waterline พื้น / ผนัง / ผนังที่ระดับผิวน้ำ			
เหมาะกับขนาดสระพื้นผิว	ไลนเนอร์, ไฟเบอร์, กระเบื้อง, กระเบื้องแก้ว		ไลนเนอร์, ไฟเบอร์, กระเบื้อง, Beadcrete	
Idea Pool Length เหมาะกับขนาดสระความ ยาวไม่เกิน	Up to 15 meters	Up to 15 meters	Up to 15 meters	Up to 15 meters
Cable Length ความยาวของสายไฟ	18 meters	18 meters	18 meters, Tangle-Free Cable	18 meters, Tangle-Free Cable
Filtration Type ระบบกรอง	Fine and ultra - fine cartridges collect both fine particles and large debris ชุดกรองแบบละเอียดและแบบละเอียดพิเศษ ที่เก็บได้ทั้งฝุ่นละเอียดและเศษชิ้นส่วนขนาดใหญ่		Super-efficient top-access multi layer filter basket, with extra sealing & large filter capacity	Super-efficient top-access multi layer filter basket, with extra sealing & large filter capacity
Full Filter Indicator ไฟเตือน กรองเต็ม	No	Yes	Yes	Yes
Cleaning Cycle เวลาทำความสะอาดต่อรอบ	2.5 hours	1.5 / 2.5 / 3.5 hours	1.5 / 2 / 2.5 hours	1 / 1.5 / 2 / 2.5 hours
Weekly Timer ตั้งเวลาทำงานล่วงหน้าเป็น อาทิตย์	No	Yes	Yes	Yes
Operation Delay ตั้งเวลาล่วงหน้า	No	Yes	Yes	Yes
Caddy รถเข็น	Yes	Yes	Yes	Yes
Smartphone MyDolphin™ App control สั่งงานผ่านแอปบนมือถือ	Yes	Yes	Yes	Yes
Gyroscope ระบบนำทาง	No	Yes	Yes	Yes
Swivel ระบบป้องกันสายพันกัน	Yes	Yes	Yes	Yes
Triple-Active Brush แปรงขัดหนัก	Yes	Yes	Yes	Yes
Carton weight น้ำหนัก	24 kgs.	26 kgs.	11.5 kgs.	11.5 kgs.
Warranty รับประกัน	36 months (Limited)	36 months (Limited)	36 months (Limited)	48 months (Limited)
Suction Rate แรงดูด	4,233 Gal/hr (16 m <sup>3</sup> /hr)	4,233 Gal/hr (16 m <sup>3</sup> /hr)	5,000 Gal/hr (19 m <sup>3</sup> /hr)	5,000 Gal/hr (19 m <sup>3</sup> /hr)

หมายเหตุ : ราคายังไม่รวมภาษี 7% บริษัทฯ ขอสงวนสิทธิ์ในการเปลี่ยนแปลงราคาโดยไม่ต้องแจ้งให้ทราบล่วงหน้า

Remarks : Excluded VAT 7%. The Company reserves the right to change the prices without announcement.



# “DOLPHIN” Wave Series (1) Automatic Robot Pool Cleaners For Commercial Pools



Code	22300400075	22300400035	22300400040	22300400045
Model	<b>WAVE20*</b>	<b>WAVE75</b>	<b>WAVE100*</b>	<b>PRO-EXPERT*</b>
Retail Price	99,000.00	107,000.00	189,000.00	369,000.00
Code✕	A			
Cleaning Coverage ครอบคลุมพื้นที่ทำความสะอาด สะอาด	Floor พื้น	Floor / Walls / Waterline พื้น / ผนัง / ผนังที่ระดับผิวน้ำ		
เหมาะกับขนาดสระพื้นผิว	ไลน์เนอร์, ไฟเบอร์, กระเบื้อง, กระเบื้องแก้ว			
Idea Pool Length เหมาะกับขนาดสระความยาว ไม่เกิน	Up to 15 meters	Up to 25 meters	Up to 25 meters	Up to 50 meters
Cable Length ความยาวของสายไฟ	24 meters	30 meters	30 meters	40 meters
Filtration Type ระบบกรอง	Filter bag 70 micron ถุงกรอง ละเอียด 70 ไมครอน	Fine filter bag ถุงกรองแบบละเอียด	Filter bag 3 options: Fine - factory default Ultra fine – extra Disposable filter bag x 5 ตัวเลือกถุงกรอง 3 แบบ: แบบละเอียด (มาตรฐานโรงงาน) แบบละเอียดพิเศษ แบบใช้ครั้งเดียวทั้ง 5 ชั้น	Filter bags options: Fine - default Ultra Fine – extra ตัวเลือกถุงกรอง : แบบละเอียด (มาตรฐานโรงงาน) แบบละเอียดพิเศษ
Full Filter Indicator ไฟเตือน กรองเต็ม	No	Yes	Yes	Yes
Cleaning Cycle เวลาทำความสะอาดต่อรอบ	1 / 3 hours	2 / 3 / 4 hours	4 / 6 / 8 hours	4 / 6 / 8 hours
Operation Delay ตั้งเวลาล่วงหน้า	Yes	Yes	Yes	Yes
Caddy รถเข็น	Yes	Yes	Yes	Yes
Remote Control รีโมทควบคุมการทำงาน	Yes	Yes	Yes	Yes
Gyroscope ระบบนำทาง	Yes	Yes	Yes	Yes
Swivel ระบบป้องกันสายพันกัน	Yes	Yes	Yes	Yes
Brush Type ชนิดแปรง	PVC	Wonder Brush แปรง ฟองน้ำชนิดพิเศษ		
Carton weight น้ำหนัก	12 kgs.	25 kgs.	26.4 kgs.	50 kgs.
Warranty รับประกัน	24 months (Limited)	24 months (Limited)	24 months (Limited)	24 months (Limited)
Suction Rate แรงดูด	4,488 Gal/hr (17 m <sup>3</sup> /hr)	4,488 Gal/hr (17 m <sup>3</sup> /hr)	4,488 Gal/hr (17 m <sup>3</sup> /hr)	8,448 Gal/hr (32 m <sup>3</sup> /hr)

\* สินค้าไม่มีสต็อก กรุณาสั่งซื้อล่วงหน้า / No Stock, Delivery Time : 30 - 60 Days

หมายเหตุ : ราคายังไม่รวมภาษี 7% บริษัทฯ ขอสงวนสิทธิ์ในการเปลี่ยนแปลงราคาโดยไม่ต้องแจ้งให้ทราบล่วงหน้า  
Remarks : Excluded VAT 7%. The Company reserves the right to change the prices without announcement.



# “DOLPHIN” Wave Series (2) Automatic Robot Pool Cleaners For Commercial Pools



Code	22300400060	22300400055	22300400050
Model	<b>WAVE150*</b>	<b>WAVE200*</b>	<b>WAVE300(XL)*</b>
Retail Price	439,000.00	495,000.00	649,000.00
Code*	A		
Cleaning Coverage ครอบคลุมพื้นที่ทำความสะอาด	Floor พื้น	Floor พื้น	Floor พื้น
เหมาะกับขนาดสระพื้นผิว	ไลน์เนอร์, ไฟเบอร์, กระเบื้อง, กระเบื้องแก้ว		
Cable Length ความยาวของสายไฟ	35 meters	35 meters	50 meters
Filtration Type ระบบกรอง	cartridge: 100 microns (*50, 300 micron and thread rotation net optional)	Spiral 2 layer system ตะกร้ากรองแบบเกลียว	Triple-level pool filtration option for fine and rough dirt ตัวเลือกกรอง 3 แบบ: แบบละเอียด (มาตรฐานโรงงาน) แบบละเอียดพิเศษ และ แบบหยาบ
Full Filter Indicator ไฟเตือน กรองเต็ม	No	Yes	Yes
Cleaning Cycle เวลาทำความสะอาดต่อรอบ	4,5,6,8 hours	1 - 8 hours	1 - 8 hours
Operation Delay ตั้งเวลาล่วงหน้า	No	Yes	Yes
Caddy รถเข็น	Yes	Yes	Yes
Remote Control รีโมทควบคุมการทำงาน	Yes	Yes	Yes
Gyroscope ระบบนำทาง	Yes	Yes	Yes
Swivel ระบบป้องกันสายพันกัน	No	No	No
Brush Type ชนิดแปรง	PVC Brush แปรงพีวีซี	PVC Brush แปรงพีวีซี	PVC Brush แปรงพีวีซี
Carton weight น้ำหนัก	24 kgs.	24 kgs.	92 kgs.
Warranty รับประกัน	24 months (Limited)	24 months (Limited)	24 months (Limited)
Suction Rate แรงดูด	8,976 Gal/hr 34 m <sup>3</sup> /hr	8,976 Gal/hr 34 m <sup>3</sup> /hr	10,560 Gal/hr 40 m <sup>3</sup> /hr

\* สินค้าไม่มีสต็อก กรุณาสั่งซื้อล่วงหน้า / No Stock, Delivery Time : 30 - 60 Days

หมายเหตุ : ราคายังไม่รวมภาษี 7% บริษัทฯ ขอสงวนสิทธิ์ในการเปลี่ยนแปลงราคาโดยไม่ต้องแจ้งให้ทราบล่วงหน้า

Remarks : Excluded VAT 7%. The Company reserves the right to change the prices without announcement.

# MAINTENANCE KITS







## “POOLSPA” Premium Vacuum Heads

Code	Model	Description	Retail Price	Code✕
22401610005	PSM-01	14” Premium Vacuum Head	1,980.00	B ★
22401610010	PSM-02	19” Premium Vacuum Head	2,990.00	



## “EMAUX” Premium Vacuum Heads

### FLEXIBLE VACUUM CLEANER

Rotary wheels for the best movement. Uniform weighted to be settled to the pool bottom surface. 360 swivel rotation for easy displacement. Laterals brushed to clean any corner. Fits vacuum hoses of 32/38 mm

Code	Model	Description	Size	Retail Price	Code✕
22400510050	CE315	Flexible Vacuum Cleaner	382 x 202 x 120 mm	2,300.00	H ★



### PROFESSIONAL VACUUM CLEANER

Designed for pool professionals to achieve the best cleaning performance. Largest bottom surface, heavy weighted with double directional wheels, 360 swivel, lateral brushed, a big heavy duty vacuum cleaner with handy movement.

Code	Model	Description	Size	Retail Price	Code✕
22400510055	CE316	Professional Vacuum Cleaner	517 x 202 x 130 mm	2,600.00	H ★



### TRIANGULAR VACUUM CLEANER

360 swivel rotation heavy duty design for easy handling and faster cleaning. Side brushed to access and clean any pool corner, internal weighted for optimum bottom pool surface displacement. Fits vacuum hoses for 32/38 mm (1.25”/1.5”)

Code	Model	Description	Size	Retail Price	Code✕
22400510060	CE317	Triangular Vacuum Cleaner	230 x 230 x 92 mm	1,600.00	H ★



### PROFESSIONAL TRIANGULAR VACUUM CLEANER

360 swivel rotation heavy duty design for easy handling and faster cleaning. Side brushed to access and clean any pool corner, internal weighted for optimum bottom pool surface displacement. Fits vacuum hoses for 38/50 mm

Code	Model	Description	Size	Retail Price	Code✕
22400510065	CE318	Professional Triangular Vacuum Cleaner	288 x 288 x 132 mm	1,600.00	H ★



หมายเหตุ : ราคายังไม่รวมภาษี 7% บริษัทฯ ขอสงวนสิทธิ์ในการเปลี่ยนแปลงราคาโดยไม่ต้องแจ้งให้ทราบล่วงหน้า

Remarks : Excluded VAT 7%. The Company reserves the right to change the prices without announcement.



# “EMAUX” Standard Vacuum Heads

## Standard Vacuum Heads

Code	Model	Description	Retail Price	Code✕
22400510120	CE310	14” Aluminum Vacuum Head (38mm connection)	2,900.00	H★
22400510125	CE311	18” Aluminum Vacuum Head (38mm connection)	3,200.00	
22400510130	CE312	18” Aluminum Vacuum Head (50mm connection)	3,500.00	



Code	Model	Description	Retail Price	Code✕
22400510005	CE301	14” Flexible Vacuum Head with Wheels	1,050.00	H★



Code	Model	Description	Retail Price	Code✕
22400510020	CE305	19” Heavy Duty Flexible Vacuum Head with Wheels	1,390.00	H★



Code	Model	Description	Retail Price	Code✕
22400510010	CE302	Vacuum Head with Brushes	1,000.00	H★



Code	Model	Description	Retail Price	Code✕
22400510015	CE304	Vacuum Head with Side Brushed	1,190.00	H★



# “EMAUX” Leaf Skimmer Nets

## SURFACE LEAF SKIMMER

Strong surface leaf skimmer, easy net replacement. Internal aluminum frame.

Standard clip attachment for any telescopic pole.

Code	Model	Description	Retail Price	Code✕
22400510100	CE107	Surface Leaf Skimmer, Size 356 x 454 x 56 mm	1,800.00	H★



Code	Model	Description	Retail Price	Code✕
22410510005	CE101	Leaf Skimmer, Deep Bag	760.00	H★



Code	Model	Description	Retail Price	Code✕
22410510010	CE102	Leaf Skimmer, Flat	500.00	H★



หมายเหตุ : ราคายังไม่รวมภาษี 7% บริษัทฯ ขอสงวนสิทธิ์ในการเปลี่ยนแปลงราคาโดยไม่ต้องแจ้งให้ทราบล่วงหน้า  
 Remarks : Excluded VAT 7%. The Company reserves the right to change the prices without announcement.



# “EMAUX” Brushes

## TECH BRUSH

High design & heavy-duty materials. Proper brushing with strong bristles. Standard clip attachment for any telescopic pole.

Code	Model	Description	Retail Price	Code✕
22400510095	CE212	Tech Brush, Size 444 x 55 x 44 mm	1,600.00	H★



## Brushes

Code	Model	Description	Retail Price	Code✕
22410510015	CE202	9” Nylon Curved Brush	380.00	H★
22410510025	CE201	18” Nylon Curved Brush	510.00	



Code	Model	Description	Retail Price	Code✕
22410510020	CE204	9” Algae Brush Stainless Steel	690.00	H★
2250471170-02	CE206	18” Algae Brush Stainless Steel	1,190.00	



# “DURAKING” Premium Vacuum Hoses

Code	Model	Description	Retail Price	Code✕
2250470730	DK-30	Length 30 ft. (9 meters) Pipe Connection 1.5”	3,600.00	N★
2250471735	DK-35	Length 35 ft. (11 meters) Pipe Connection 1.5”	4,100.00	
2250470740	DK-40	Length 40 ft. (12 meters) Pipe Connection 1.5”	4,900.00	
2250470745	DK-45	Length 45 ft. (13 meters) Pipe Connection 1.5”	5,500.00	
2250470750	DK-50	Length 50 ft. (15 meters) Pipe Connection 1.5”	6,190.00	



# “EMAUX” Standard Vacuum Hoses

Code	Model	Description	Retail Price	Code✕
2250470774	CE154	Length 30 ft. (9 meters) Pipe Connection 1.5”	2,090.00	H★
2250470772	CE155	Length 35 ft. (11 meters) Pipe Connection 1.5”	2,490.00	
2250470771	CE156	Length 45 ft. (13 meters) Pipe Connection 1.5”	2,690.00	
2250470770	CE157	Length 50 ft. (15 meters) Pipe Connection 1.5”	3,190.00	



หมายเหตุ : ราคายังไม่รวมภาษี 7% บริษัทฯ ขอสงวนสิทธิ์ในการเปลี่ยนแปลงราคาโดยไม่ต้องแจ้งให้ทราบล่วงหน้า  
 Remarks : Excluded VAT 7%. The Company reserves the right to change the prices without announcement.



## “EMAUX” Telescopic Poles

Code	Model	Description	Retail Price	Code✘
22410510030	CE132	Size 2 x 2.4 meters	1,400.00	H ★
22410510035	CE133	Size 2 x 3.0 meters	1,800.00	
2250470785-05	CE135	Size 2 x 4.0 meters	2,500.00	



## “EMAUX” Chemical Dispenser

### CHEMICAL TABLETS DISPENSER

Optimum floatability with cute design, regulable opening for proper dosing, healthy pool. Premium ABS materials. Capacity: 3 tablets of 200 grams of Chlorine.

Code	Model	Description	Retail Price	Code✘
22400510105	CE502	Chemical Tablets Dispenser, Size 276 x 128 mm	790.00	H ★



### HEAVY DUTY PROFESSIONAL FLOATING TABLETS DISPENSER

Premium design for proper floating & dosing, premium ABS materials. Capacity: 5 tablets of 200 grams of Chlorine.

Code	Model	Description	Retail Price	Code✘
22400510110	CE503	Heavy Duty Professional Floating Tablets Dispenser, Size 276 x 188 mm	790.00	H ★



Code	Model	Type	Retail Price	Code✘
21060510005	CE501	Deluxe Chemical Dispenser - Floating	530.00	H ★



หมายเหตุ : ราคายังไม่รวมภาษี 7% บริษัทฯ ขอสงวนสิทธิ์ในการเปลี่ยนแปลงราคาโดยไม่ต้องแจ้งให้ทราบล่วงหน้า  
Remarks : Excluded VAT 7%. The Company reserves the right to change the prices without announcement.



# “EMAUX” Thermometers

## Top Visual Floating Thermometer

Large numbers, buoy design high stability and easy reading

Code	Model	Description	Retail Price	Code✘
22400510115	CE405	Top Visual Floating Thermometer, Size 165 x 165 x 168 mm	1,000.00	H★

Code	Model	Description	Retail Price	Code✘
2020230050	CE401	Deluxe Floating Thermometer with String	240.00	H★
2020230051	CE402	Economy Thermometer	190.00	



# “EMAUX” Digital Meters

Model	Salinity Range	Accuracy	Salinity Resolution	Temperature Range	Operating RH%
8371	0-10.00ppt(NaCl) 10.1-70.0ppt(NaCl)	+/-1%F.S +/- 1 digit 1ppm or 0.01ppt +/-2%F.S +/- 1 digit (10.1~70.0 ppt)	0.01 0.1(10.1~70.0ppt)	0~50.0°C	Humidity < 80%

Code	Model	Tests for	Range	Retail Price	Code✘
22200510005	AZ8371	Salinity	Salinity: 0-10.00 ppt	3,900.00	H★

Code	Model	Tests for	Retail Price	Code✘
22200510010	8552	ORP	4,500.00	H★

Code	Model	Tests for	Retail Price	Code✘
22200510015	8686	pH/Temp	3,900.00	H★



# “EMAUX” Test Kit

Code	Model	Description	Retail Price	Code✘
22401110015	CE029	pH & CL Test Kit	360.00	H★



หมายเหตุ : ราคายังไม่รวมภาษี 7% บริษัทฯ ขอสงวนสิทธิ์ในการเปลี่ยนแปลงราคาโดยไม่ต้องแจ้งให้ทราบล่วงหน้า  
 Remarks : Excluded VAT 7%. The Company reserves the right to change the prices without announcement.



# STEAM GENERATORS



# “HARVIA” HGX Series Residential Steam Generator Complete Set With Controller

Harvia HGX is a compact, yet efficient steam generator intended for private and spa use. Designed for high output demanding spa use, reliable, trouble-free operation and the relaxing steam bath experience have been the main design principles.

### RELIABILITY THROUGH INNOVATIONS

- Water level is measured in clean water, in a separated measuring cup to prevent problems caused by water impurities
- A sediment cup collects water impurities that fall on the bottom of the water container

### EASY TO USE & EASY MAINTENANCE

- Stylish touch-screen control panel
- Basic maintenance – sediment cup emptying and checking the water level sensor – can be done without opening the cover of the unit.

### COMPACT DESIGN

Harvia HGX can be install in a low space i.e. on the top of the steam cabin. The steam and water connections are on the side of the unit.

### STYLISH TOUCH-SCREEN CONTROL PANEL

The steam generator is controlled by a separate touch-screen control panel.

### CONTROL FUNCTIONS

- Steam generator (Temperature, on-time, delay start)
- Fragrance pump
- Lighting
- Fan



## Installation measurements

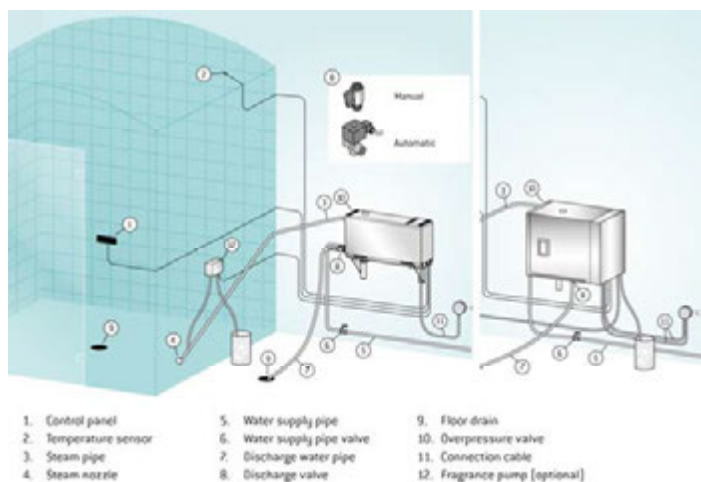
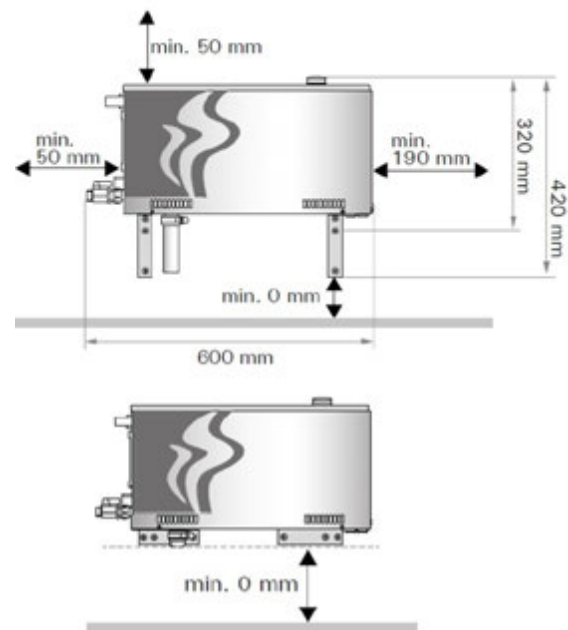



Technical data

Model	Output	Recommended steam room size [m <sup>3</sup> ]						Steam output capacity	230 V 1N ~		400 V 3N ~	
		Light wall (acrylic, etc.)		Tiled light wall		Tiled stone wall, etc.			Cable	Fuse	Cable	Fuse
	kW	Ventilated	Not ventilated	Ventilated	Not ventilated	Ventilated	Not ventilated	kg/h	mm <sup>2</sup>	A	mm <sup>2</sup>	A
HGX2	2,2	2-4	2-4	2-4	2-4	2-4	2-4	2,0	3 x 1,5	10	-	-
HGX45	4,5	2-5	2-7	2-4	2-6	2-3,5	2-4,5	5,5	3 x 6	25	5 x 1,5	3 x 10
HGX60	5,7	2,5-8	3,5-11	2-6	3-9	2-5	2-7,5	7,6	3 x 6	25	5 x 1,5	3 x 10
HGX90	9,0	6-12	9-17	4,5-10	7,5-14	3-8	6-11,5	12,0	-	-	5 x 2,5	3 x 16
HGX11	10,8	10-14,5	15-21	8-12	12-17	6-10	10-14	14,6	-	-	5 x 2,5	3 x 16
HGX15	15,0	12-19,5	17-28	10-16	14-23	8-13,5	12-18,5	20,1	-	-	5 x 6	3 x 25
HGP22	21,6	20-29	30-42	16-24	24-34	12-20	20-28	29,2	-	-	2 x 5 x 6	2 x 3 x 16
HGP30	30,0	24-39	34-56	20-32	28-46	16-27	24-37	40,2	-	-	2 x 5 x 6	2 x 3 x 25
Multidrive (example)												
HGX45 + HGX11L	15,3	12-19,5	17-28	10-16	14-23	8-13,5	12-18,5	20,1	-	-	5 x 1,5 + 5 x 2,5	3 x 10 + 3 x 16
HGX60 + HGX11L	16,5	12,5-22,5	18,5-32	10-18	15-26	8-15	12-21,5	22,2	-	-	5 x 1,5 + 5 x 2,5	3 x 10 + 3 x 16
HGX90 + HGX11L	19,8	16-26,5	24-38	12,5-22	19,5-31	9-18	16-25,5	26,6	-	-	2 x 5 x 2,5	2 x 3 x 16
HGX11 + HGX11L	21,6	20-29	30-42	16-24	24-34	12-20	20-28	29,2	-	-	2 x 5 x 2,5	2 x 3 x 16

Dimensions:

- HGX: width 600 mm, depth 155 mm, height 320 mm. Weight: 9 kg (water reservoir empty), 13 kg (water reservoir full)
- HGP: width 560 mm, depth 320 mm, height 490 mm. Weight: 24 kg (water reservoir empty), 33 kg (water reservoir full)

Include: Steam Generator, Control Panel, Temperature Sensor and Steam Nozzle 1 pc

HGX Series Steam Generator Complete Set With Controller

Code	Model	Power (kW)	Room Size (m <sup>3</sup> ) (Tiles Light Wall, Not Ventilated)	Retail Price	Code✘
22700820005	HGX2	2.2	2 - 4	78,000.00	B ★
22700820010	HGX45	4.5	2 - 6	82,000.00	
22700820015	HGX60	5.7	3 - 9	85,000.00	
22700820020	HGX90	9.0	7.5 - 14	96,000.00	
22700820025	HGX11	10.8	12 - 17	99,900.00	
22700820030	HGX15	15.0	14 - 23	111,000.00	

HGX-XW Series Steam Generator Complete Set With Controller & Wifi



Code	Model	Power (kW)	Room Size (m <sup>3</sup> ) (Tiles Light Wall, Not Ventilated)	Retail Price	Code✘
22700820070	HGX2XW ✘	2.2	2 - 4	94,000.00	B ★
22700820075	HGX45XW ✘	4.5	2 - 6	99,000.00	
22700820080	HGX60XW ✘	5.7	3 - 9	102,000.00	
22700820085	HGX90XW ✘	9.0	7.5 - 14	116,000.00	
22700820090	HGX11XW ✘	10.8	12 - 17	120,000.00	
22700820095	HGX15XW ✘	15.0	14 - 23	132,000.00	

✘ สินค้าไม่มีสต็อก กรุณาสั่งซื้อล่วงหน้า / No Stock, Delivery Time : 30 - 60 Days

หมายเหตุ : ราคายังไม่รวมภาษี 7% บริษัทฯ ขอสงวนสิทธิ์ในการเปลี่ยนแปลงราคาโดยไม่ต้องแจ้งให้ทราบล่วงหน้า  
Remarks : Excluded VAT 7%. The Company reserves the right to change the prices without announcement.





# “HARVIA” HGD Series Commercial Steam Generator Complete Set With Controller

The Harvia HGD steam generator is a source of well-being and relaxation. Thanks to its easy-care structure and large water container, HGD is also excellently suited for heavy-duty spa use – tasked with providing your customers with perfect moments of relaxation for the mind and body, 24/7.

The touch-screen control panel of the steam generator allows you to easily add to the atmosphere with the help of lighting and fragrances. You can control all the steam generators in your spa with one control panel. The perfect steam sauna experience is guaranteed by Harvia’s more than 60 years of experience in heat technology as a source of well-being.



## Installation measurements

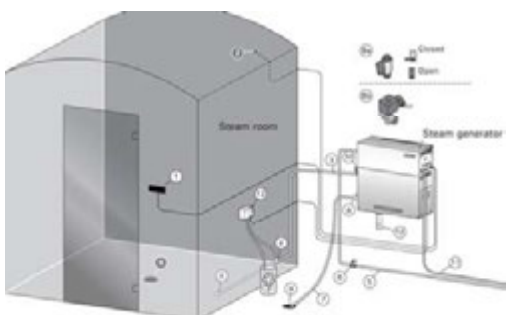
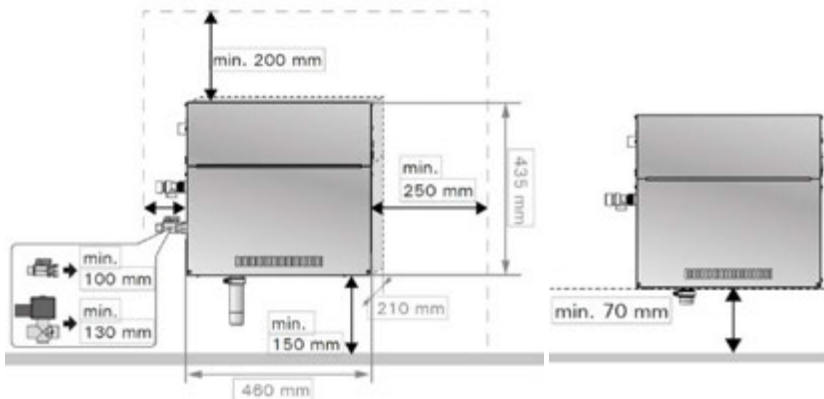

1. Control panel
2. Temperature sensor
3. Steam pipe
4. Steam nozzle
5. Water supply pipe
6. Water supply pipe valve
7. Discharge water pipe
  
- 8a. Manual discharge valve
- 8b. Automatic discharge valve (optional)
9. Floor drain
10. Overpressure valve
11. Connection cable
12. Fragrance pump (optional)
13. Sediment cup

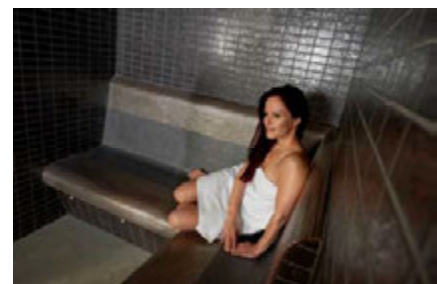



Technical data

Model Modell	Output Leistung	Recommended steam room size (m³) Empfohlene Dampfkabinengröße (m³)						Steam output capacity Dampf- ausgabe- kapazität	230 V 1N~		400 V 3N~	
		Light wall (acrylic, etc.) Leichtbauwand (Acryl, usw.)		Tiled light wall Geflieste Leichtbauwand		Tiled stone wall, etc. Geflieste Steinwand, usw.			Cable Kabel	Fuse Sicherung	Cable Kabel	Fuse Sicherung
HGD45	4,5	* 2-5	** 2-7	* 2-4	** 2-6	* 2-3,5	** 2-4,5	5,5	3 x 6	25	5 x 1,5	3 x 10
HGD60	5,7	2,8-8	3,5-11	2-6	3-9	2-5	2-7,5	7,6	3 x 6	32	5 x 1,5	3 x 10
HGD90	9,0	6-12	9-17	4,5-10	7,5-14	3-8	6-11,5	12,0	3 x 10	40	5 x 2,5	3 x 16
HGD110	10,8	10-14,5	15-21	8-12	12-17	6-10	10-14	14,6	-	-	5 x 2,5	3 x 16
HGD150	15,0	12-19,5	17-28	10-16	14-23	8-13,5	12-18,5	20,1	-	-	5 x 2,5	3 x 25

Include: Steam Generator, Control Panel, Temperature Sensor and Steam Nozzle 1 pc

HGD Series Commercial Steam Generator Complete Set With Controller

Code	Model	Power (kW)	Room Size (m³)		Retail Price	Code✘
			(Tiles Light Wall, Not Ventilated)			
22700820035	HGD45 ✘	4.5	2 – 4.5		103,000.00	B ★
22700820040	HGD60 ✘	5.7	2 – 7.5		108,000.00	
22700820045	HGD90 ✘	9.0	6 – 11.5		117,000.00	
22700820050	HGD110 ✘	10.8	10 – 14		121,000.00	
22700820055	HGD150 ✘	15	12 – 18.5		133,000.00	

HGD-XW Series Commercial Steam Generator Complete Set With Controller & Wifi



Code	Model	Power (kW)	Room Size (m³)		Retail Price	Code✘
			(Tiles Light Wall, Not Ventilated)			
22700820100	HGD45XW ✘	4.5	2 – 4.5		124,000.00	B ★
22700820105	HGD60XW ✘	5.7	2 – 7.5		130,000.00	
22700820110	HGD90XW ✘	9.0	6 – 11.5		140,000.00	
22700820115	HGD110XW ✘	10.8	10 – 14		146,000.00	
22700820120	HGD150XW ✘	15	12 – 18.5		159,000.00	

✘ สินค้าไม่มีสต็อก กรุณาสั่งซื้อล่วงหน้า / No Stock, Delivery Time : 30 - 60 Days

หมายเหตุ : ราคายังไม่รวมภาษี 7% บริษัทฯ ขอสงวนสิทธิ์ในการเปลี่ยนแปลงราคาโดยไม่ต้องแจ้งให้ทราบล่วงหน้า  
Remarks : Excluded VAT 7%. The Company reserves the right to change the prices without announcement.



# “HARVIA” HGP Series Commercial Steam Generator Complete Set With Controller

The Harvia HGP steam generator is a source of well-being and relaxation. Thanks to its steam-generating power, Harvia HGP is suited for especially demanding spa use – with the mission of providing your customers with perfect moments of relaxation for body and mind, 24/7. Equip the steam generator with an accessory touch control panel to easily create more atmosphere, lighting and fragrances in your steam room. The perfect steam room experience is guaranteed by Harvia’s more than 60 years of experience in heat technology as a source of well-being.

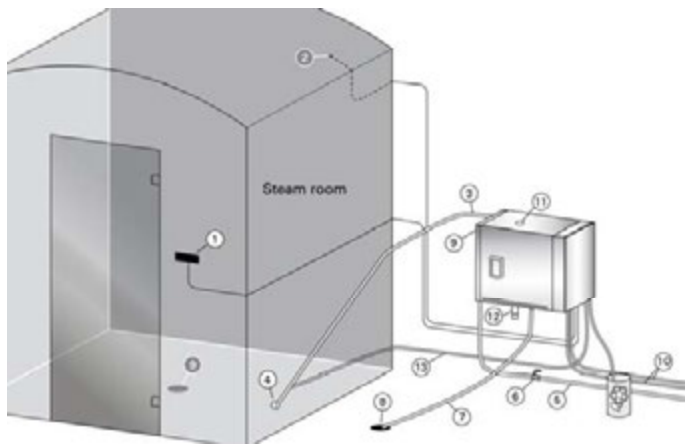

1. Control panel
2. Temperature sensor
3. Steam pipe
4. Steam nozzle
5. Water supply pipe
6. Water supply pipe valve
7. Discharge water pipe
8. Floor drain
9. Overpressure valve
10. Connection cable
11. Rubber plug
12. Sediment cup
13. Tube for fragrance pump

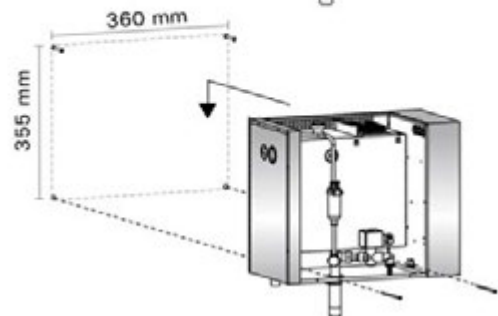
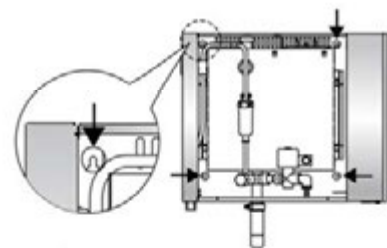
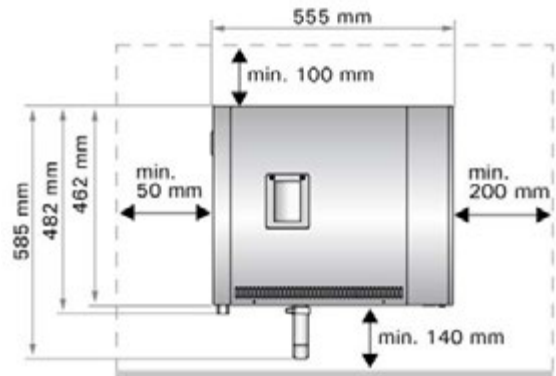

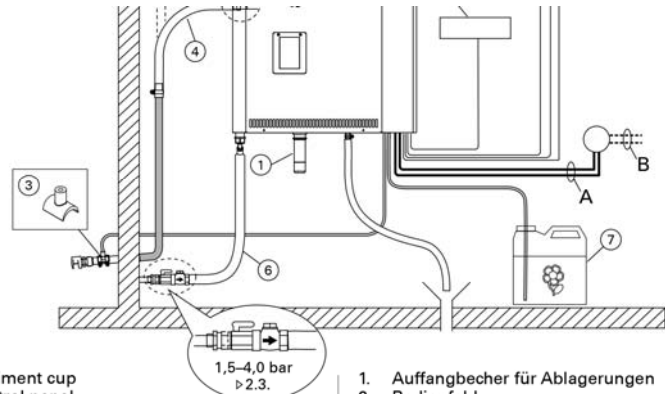

- |   |  |
|---|--|
| <ol style="list-style-type: none"> <li>1. Sediment cup</li> <li>2. Control panel</li> <li>3. Connection part for fragrance pump</li> <li>4. Steam pipe</li> <li>5. Steam pipe (alternative)</li> <li>6. Water supply pipe</li> <li>Optional parts and devices:</li> <li>7. Fragrance</li> </ol> | <ol style="list-style-type: none"> <li>1. Auffangbecher für Ablagerungen</li> <li>2. Bedienfeld</li> <li>3. Verbindungsstück für die Duftkonzentratpumpe</li> <li>4. Dampfrohr</li> <li>5. Dampfrohr (alternativ)</li> <li>6. Wasserzuleitung</li> <li>Optionale Teile und Zubehör:</li> <li>7. Duftkonzentrate</li> </ol> |
|---|--|

Model Modell	Output Leistung	Recommended steam room size (m <sup>3</sup> ) Empfohlene Dampfkabinengröße (m <sup>3</sup> )						Steam output capacity Dampfausgabekapazität	400 V 3N~ Cable Kabel		Fuse Sicherung
		Light wall (acrylic, etc.) Leichtbauwand (Acryl, usw.)		Tiled light wall Geflieste Leichtbauwand		Tiled stone wall, etc. Geflieste Steinwand, usw.			A	B	
	kW	*	**	*	**	*	**	kg/h	mm <sup>2</sup>	mm <sup>2</sup>	A
HGP22	21,6	20-29	30-42	16-24	24-34	12-20	20-28	29,2	(2 x) 5 x 2,5	(2 x) 5 x 2,5	(2 x) 3 x 16
HGP30	30,0	24-39	34-56	20-32	28-46	16-27	24-37	40,2	(2 x) 5 x 2,5	(2 x) 5 x 6	(2 x) 3 x 25

Model Modell	Width Breite	Depth Tiefe	Height Höhe	Weight (water reservoir empty) Gewicht (mit leerem Wassertank)	Weight (water reservoir full) Gewicht (mit vollem Wassertank)
HGP22-HGP30(L)	560 mm	320 mm	490 mm	24 kg	33 kg

\* ventilated      \*\* not ventilated

Include: Steam Generator, Control Panel, Temperature Sensor and Steam Nozzle 1 pc)

Code	Model	Power (kW)	Room Size (m <sup>3</sup> ) (Tiles Light Wall , Not Ventilated)	Retail Price	Code✳
22700820060	HGP22 ✳	21.6	20 – 28	กรุณาติดต่อเจ้าหน้าที่ / Please Check with Sales Assistance	
22700820065	HGP30 ✳	30	24 – 37		

✳ สินค้าไม่มีสต็อก กรุณาสั่งซื้อล่วงหน้า / No Stock, Delivery Time : 30 - 60 Days

หมายเหตุ : ราคายังไม่รวมภาษี 7% บริษัทฯ ขอสงวนสิทธิ์ในการเปลี่ยนแปลงราคาโดยไม่ต้องแจ้งให้ทราบล่วงหน้า  
Remarks : Excluded VAT 7%. The Company reserves the right to change the prices without announcement.



“HARVIA” Steam Accessories

Code	Model	Descriptions	Retail Price	Code✖
22710820005	ZG-500 ✖	Steam nozzle Size: D 14 x W 9 x H 12 cm	กรุณาติดต่อเจ้าหน้าที่ / Please Check with Sales Assistance	



Code	Model	Descriptions	Retail Price	Code✖
22710820030	ZG-520 ✖	Steam nozzle, Silent Size: D 4 x W 28.5 x H 28.5 cm	กรุณาติดต่อเจ้าหน้าที่ / Please Check with Sales Assistance	



Code	Model	Descriptions	Retail Price	Code✖
22710820020	ZG-700 ✖	Automatic discharge valve Size: D 19 x W 13 x H 30 cm	กรุณาติดต่อเจ้าหน้าที่ / Please Check with Sales Assistance	



Code	Model	Descriptions	Retail Price	Code✖
22710820015	ZG-900 ✖	Fragrance pump	กรุณาติดต่อเจ้าหน้าที่ / Please Check with Sales Assistance	

Code	Model	Descriptions	Retail Price	Code✖
22640820365	WX311 ✖	5 m, Globe, Cilindro EE 11kW, Griffin, Xenio, Xafir	กรุณาติดต่อเจ้าหน้าที่ / Please Check with Sales Assistance	
22640820415	WX315 ✖	10 m, Globe, Cilindro EE 11kW, Griffin, Xenio, Xafir		

Code	Model	Descriptions	Retail Price	Code✖
22640820420	ZSTM-400 ✖	Silicon hose 19/23, price per meter	กรุณาติดต่อเจ้าหน้าที่ / Please Check with Sales Assistance	
22640820425	ZSTM-214 ✖	Silicon hose 25/29, price per meter		

✖ สินค้าไม่มีสต็อก กรุณาสั่งซื้อล่วงหน้า / No Stock, Delivery Time : 30 - 60 Days

หมายเหตุ : ราคายังไม่รวมภาษี 7% บริษัทฯ ขอสงวนสิทธิ์ในการเปลี่ยนแปลงราคาโดยไม่ต้องแจ้งให้ทราบล่วงหน้า  
Remarks : Excluded VAT 7%. The Company reserves the right to change the prices without announcement.



# SAUNA HEATERS & ROOMS



# “HARVIA” Cilindro Series Residential Sauna Heaters

The Harvia Cilindro electric heater contains a massive amount of stones. Thanks to the grate-like outer shell, each bather can adjust the nature of the steam: soft when throwing water onto the side of the heater and sharp when throwing water straight on top of the stone pillar. Cilindro is impressive to both look at and experience.

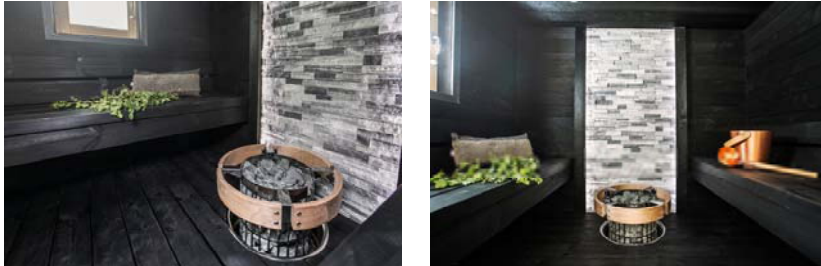

Option :  
Sauna controller  
Model CX180S &  
X180M

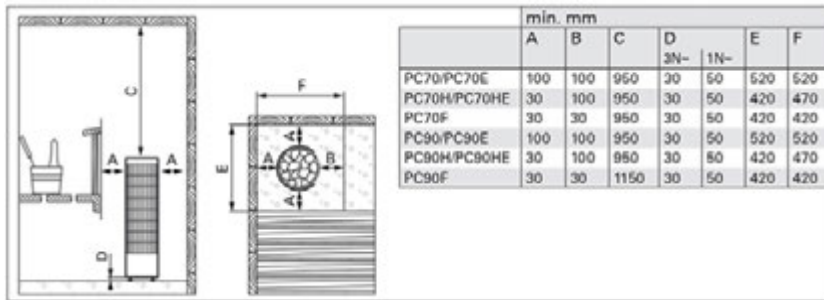

### CILINDRO E Series Need Separate Controller

Code	Model	Power (kW)	Stone (kg)	Room Size (m <sup>3</sup> )	Room Height (cm)	Suitable With Controller	Retail Price	Code✘
22600820170	PC70E	6.8 kW/3PH	80 kgs	10	190	CX180 S	17,900.00	B★
22600820175	PC90E	9.0 kW/3PH	(5-10cm)	14		CX180 M	19,900.00	

### CILINDRO-XE (WIFI) Series Residential Sauna Heaters, With separate control panel



Code	Model	Power (kW)	Stone (kg)	Room Size (m <sup>3</sup> )	Room Height (cm)	Suitable With Controller	Retail Price	Code✘
22600820265	PC70XE *	6.8 kW/3PH	80 kgs	10	190	CX180 S	47,900.00	B★
22600820270	PC90XE *	9.0 kW/3PH	(5-10cm)	14		CX180 M	49,900.00	



Code	Model	Descriptions	Retail Price	Code✘
22600820180	HPC3	Safety Railing For Cilindro Heaters 6.0 – 9.0 kW	20,900.00	B

✘✘ราคาไม่รวมหิน / Excluded Stone

✘✘ราคาไม่รวมชุดคอนโทรล / Excluded Controller

หมายเหตุ : ราคายังไม่รวมภาษี 7% บริษัทฯ ขอสงวนสิทธิ์ในการเปลี่ยนแปลงราคาโดยไม่ต้องแจ้งให้ทราบล่วงหน้า

Remarks : Excluded VAT 7%. The Company reserves the right to change the prices without announcement.



# “HARVIA” Cilindro Pro Series Commercial Sauna Heaters

The Cilindro Pro electric heater gives off hearty steam in a family sauna, but the superior features of the heater are especially beneficial to commercial saunas, hotels and housing companies, for example. The impressive tall pillar heater contains a massive amount of stones, and the robust heat elements are designed to withstand long operating times. This guarantees plenty of hearty steam for large groups of bathers. When you want the most out of your heater, choose the professional quality of the world’s largest sauna heater manufacturer.



Option :  
Sauna controller  
Model CX180S &  
CX180M

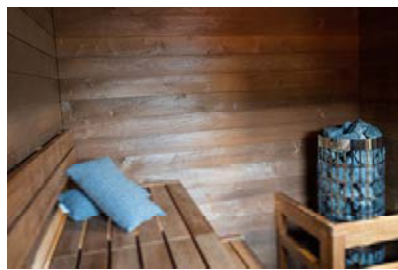
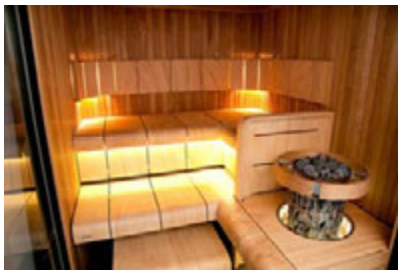

### “CILINDRO Pro” Series Need Separate Controller

Code	Model	Power (kW)	Stone (kg)	Room Size (m <sup>3</sup> )	Room Height (cm)	Suitable With Controller	Retail Price	Code✖
22600820185	PC100E/135E ✖	10.0 kW / 13.2 kW / 3PH	140 kgs (10 - 15cm)	20	190	CX180 M	64,900.00	B ★
22600820190	PC165E/200E ✖	16.6 kW / 19.8 kW / 3PH		30		CX180 M	74,900.00	



HPC5



HPC6



HPC7

Code	Model	Descriptions	Retail Price	Code✖
22600820480	HPC5 ✖	Protective Plate For Cilindro Pro Heaters	12,000.00	B
22600820195	HPC6 ✖	Safety Railing For Cilindro Pro Heaters 10.0 – 13.0 kW	31,900.00	
22600820485	HPC7 ✖	Embedding Flange For Cilindro Pro Heaters	22,000.00	

✖✖ ราคาไม่รวมหิน / Excluded Stone

✖✖ ราคาไม่รวมชุดคอนโทรล / Excluded Controller

✖ สินค้าไม่มีสต็อก กรุณาลงชื่อล่วงหน้า / No Stock, Delivery Time : 30 - 60 Days

หมายเหตุ : ราคายังไม่รวมภาษี 7% บริษัทฯ ขอสงวนสิทธิ์ในการเปลี่ยนแปลงราคาโดยไม่ต้องแจ้งให้ทราบล่วงหน้า  
Remarks : Excluded VAT 7%. The Company reserves the right to change the prices without announcement.





# “HARVIA” Globe E Series Commercial Sauna Heaters

Harvia Globe is also an example of environmentally friendly design: The finest raw material – sturdy stainless steel – is used by producing as little waste as possible and no harmful chemicals are used in its surface finish. A completely new way of thinking is also apparent in the design of the heater, which is made out of precisely laser-cut steel arches and rings. The amount of sauna stones is carefully optimized: The heater heats up quickly without sacrificing the softness of the steam.

Heater Ofen	Output Leistung	Dimensions Abmessungen		Stones Steine	Sauna room Saunakabine		
		Width/Depth/Height Breite/Tiefe/Höhe	Weight Gewicht		Cubic vol. Rauminhalt		Height Höhe
	kW	mm	kg	max. kg	min. m³	max. m³	min. mm
GL70/GL70E	6,9	430/430/875-1165	10	50	6	10	1900
GL110/GL110E	10,5	500/500/955-1245	14	80	9	15	1900

Table 2. Installation details

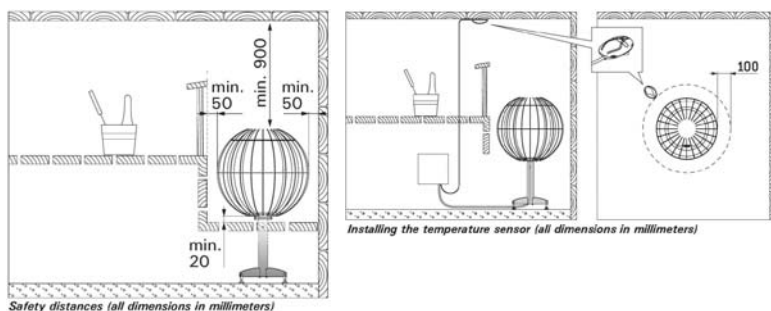

Option :  
Sauna controller  
Model CX170400

### Need Separate Controller

Code	Model	Name	Power (kW)	Max. Stone (kg)	Room Size (m³)	Retail Price	Code✘
22600820205	GL70E✘	Globe GL70E	7 kW / 3PH	50	6 - 10	129,000.00	B
22600820210	GL11E✘	Globe GL110E	11 kW / 3PH	80	9 - 15	152,000.00	

The Harvia HGL6 safety railing is a stylish way to increase safety around the impressive 6.9 kW Harvia Globe heater. Installed around the Globe heater, the safety railing is made of heat-treated aspen, creating a tangible design atmosphere for the sauna decoration scheme as well. For safe sauna experiences – Harvia.



Code	Model	Description	Retail Price	Code✘
22640820430	HGL6✘	Safety Railing For Globe Heaters 7 kW	46,000.00	B
22640820435	HGL7✘	Safety Railing For Globe Heaters 11 kW	49,000.00	

✘✘ ราคาไม่รวมหิน / Excluded Stone

✘✘ ราคาไม่รวมชุดคอนโทรล / Excluded Controller

✘ สินค้าไม่มีสต็อก กรุณาสั่งซื้อล่วงหน้า / No Stock, Delivery Time : 30 - 60 Days

หมายเหตุ : ราคายังไม่รวมภาษี 7% บริษัทฯ ขอสงวนสิทธิ์ในการเปลี่ยนแปลงราคาโดยไม่ต้องแจ้งให้ทราบล่วงหน้า

Remarks : Excluded VAT 7%. The Company reserves the right to change the prices without announcement.



# “HARVIA” Vega Compact Series Residential Sauna Heaters

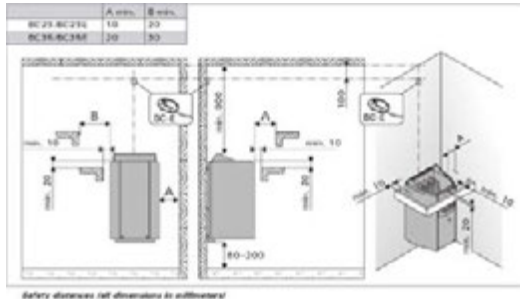

Heater Ofen	Out- put Leis- tung	Sauna room Saunakabine		Electrical connections Elektroanschlüsse					
		Cubic vol. Rauminhalt	Height Höhe	400 V 2N – Connecting cable Anschlusskabel		230 V 1N – Connecting cable Anschlusskabel		To sensor (BC-E) An Fühler (BC-E)	
Model and dimensions/ Modell und Maße		> 2.3.		See fig. 7. The measurements apply to the connecting cable only! Siehe Abbildung 7. Die Messungen beziehen sich ausschließlich auf das Anschlusskabel!					
Width/Breite 280 mm Depth/Tiefe • BC 295 mm • BC-E 270 mm Height/Höhe 505 mm Weight/Gewicht 7 kg Stones/Steine max. 12 kg									
	kW	min. m³	max. m³	min. mm	mm²	A	mm²	A	mm²
BC23/BC23E	2,3	1,3	2,5	1700	4 x 1,5	2 x 10	3 x 1,5	1 x 10	4 x 0,25
BC35/BC35E	3,5	2	4,5	1700	4 x 1,5	2 x 10	3 x 2,5	1 x 16	4 x 0,25

Table 2. Installation details



Option :  
Sauna controller  
Model CX180S &  
CX180M



### With Built-In Controller

Code	Model	Power (kW)	Stone (kg)	Room Size (m³)	Room Height (cm)	Suitable With Controller	Retail Price	Code✘
22600820160	BC23	2.3 kW / 1PH	12	1.3 - 2.5	190	Included	15,100.00	B ★
22600820165	BC35	3.5 kW / 1PH		2 - 3.8			16,500.00	

### Need Separate Controller

Code	Model	Power (kW)	Stone (kg)	Room Size (m³)	Room Height (cm)	Suitable With Controller	Retail Price	Code✘
22600820150	BC23 E	2.3 kW / 1PH	12	1.3 - 2.5	190	CX180 S	11,000.00	B ★
22600820155	BC35 E	3.5 kW / 1PH		2 - 3.8		CX180 S	12,300.00	



✘✘ ราคาไม่รวมหิน / Excluded Stone

หมายเหตุ : ราคายังไม่รวมภาษี 7% บริษัทฯ ขอสงวนสิทธิ์ในการเปลี่ยนแปลงราคาโดยไม่ต้องแจ้งให้ทราบล่วงหน้า  
Remarks : Excluded VAT 7%. The Company reserves the right to change the prices without announcement.



# “HARVIA” Vega Series Residential Sauna Heaters

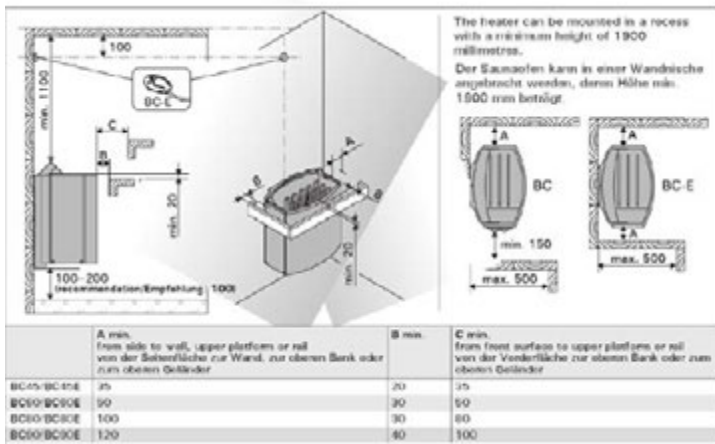

Option :  
Sauna controller  
Model CX180S &  
CX180M

Heater Ofen	Output Leistung	Sauna room Saunakabine		Electrical connects Elektronanschlässe					
		Cubic vol. Rauminhalt	Height Höhe	400 V 3N~ Connecting cable Anschlusskabel		230 V 1N~ Connecting cable Anschlusskabel		To sensor (BC-E) An Fühler (BC-E)	
Model and dimensions/ Modell und Maße									
Width/Breite • BC 480 mm • BC-E 450 mm Depth/Tiefe 310 mm Height/Höhe 640 mm Weight/Gewicht 11 kg Stones/Steine max. 20 kg		p.2.3.		See fig. 8. The measurements apply to the connecting cable only! Siehe Abbildung 8. Die Messungen beziehen sich ausschließlich auf das Anschlusskabel!					
	kW	min. m³	max. m³	min. mm	mm²	A	mm²	A	mm²
BC45/BC45E	4,5	3	6	1900	5 x 1,5	3 x 10	3 x 2,5	1 x 20	4 x 0,25
BC60/BC60E	6,0	5	8	1900	5 x 1,5	3 x 10	3 x 2,5	1 x 35	4 x 0,25
BC80/BC80E	8,0	7	12	1900	5 x 2,5	3 x 16	3 x 6	1 x 35	4 x 0,25
BC90/BC90E	9,0	8	14	1900	5 x 2,5	3 x 16	3 x 10	1 x 50	4 x 0,25

Table 2. Installation details

### With Built-In Controller

Code	Model	Power (kW)	Stone (kg)	Room Size (m³)	Room Height (cm)	Suitable With Controller	Retail Price	Code✘
22600820005	BC45	4.5 kW / 1PH	25	3 - 6	190	Included	17,900.00	B★
22600820010	BC60	6.0 kW / 3PH		5 - 8			18,700.00	
22600820015	BC80	8.0 kW / 3PH		7 - 12			20,000.00	
22600820020	BC90	9.0 kW / 3PH		8 - 14			20,600.00	

### Need Separate Controller

Code	Model	Power (kW)	Stone (kg)	Room Size (m³)	Room Height (cm)	Suitable With Controller	Retail Price	Code✘
22600820045	BC45 E	4.5 kW / 1PH	25	3 - 6	190	CX180 S	13,700.00	B★
22600820050	BC60 E	6.0 kW / 3PH		5 - 8		CX180 S	14,500.00	
22600820055	BC80 E	8.0 kW / 3PH		7 - 12		CX180 S	15,600.00	
22600820060	BC90 E	9.0 kW / 3PH		8 - 14		CX180 M	15,900.00	

✘✘ ราคาไม่รวมหิน / Excluded Stone

หมายเหตุ : ราคายังไม่รวมภาษี 7% บริษัทฯ ขอสงวนสิทธิ์ในการเปลี่ยนแปลงราคาโดยไม่ต้องแจ้งให้ทราบล่วงหน้า

Remarks : Excluded VAT 7%. The Company reserves the right to change the prices without announcement.



# “HARVIA” Vega Pro Series Commercial Sauna Heaters

Vega Pro is a stylish and efficient floor-mounted electric heater that is suitable for family saunas as well as public saunas in clubs, wellness centers, hotels, holiday resorts and indoor swimming pools.

The Vega Pro models BC105, BC135 and BC165 are controlled by a separate control unit.



Heater/Ofen Model and dimensions/ Modell und Maße	Output Leistung kW	Saunaroom Saunakabine		Minimum distances Min. Abstand des Ofen					Cables Kabel			Fuse Sicherung A
		Cubic vol. Rauminhalt min m <sup>3</sup> / max m <sup>3</sup>	Height Höhe min mm / max mm	A min. mm	A max. mm	B min. mm	C min. mm	To floor zum Boden mm	To control unit zum Steuergerät mm <sup>2</sup>	To sensor zum Fühler mm <sup>2</sup>	Connecting cable to heater Anschlußkabel zum Ofen mm <sup>2</sup>	
BC105	10.5	9 / 15	1900	50 / 150	50	1250	30	5 x 2.5	4 x 0.25	5 x 2.5	3 x 16	
BC135	13.5	11 / 20	2100	80 / 180	80	1450	30	5 x 4.0	4 x 0.25	5 x 2.5	3 x 20	
BC165	16.5	16 / 30	2100	100 / 200	100	1450	30	5 x 6.0	4 x 0.25	5 x 2.5	3 x 25	

Table 1. Installation details    Tabell 1. Montageinformationen

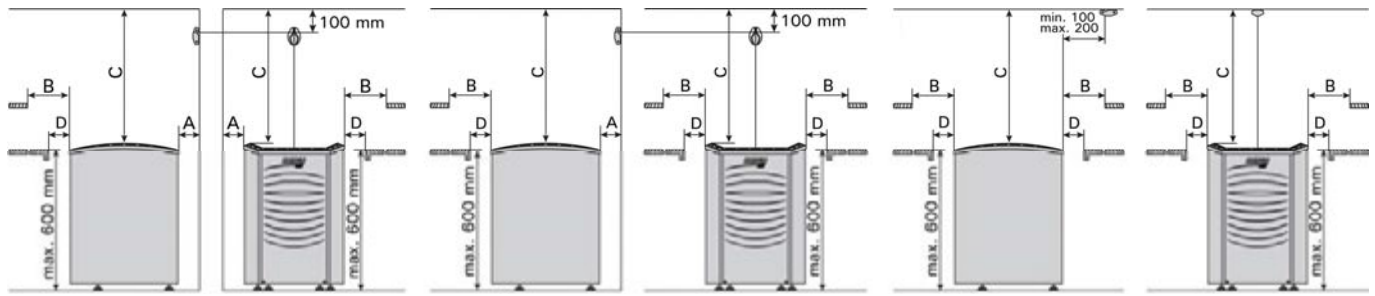

Model Modell	A min. mm	A max. mm	B min. mm	C min. mm	D min. mm
BC105	50	150	50	1250	50
BC135	80	180	80	1450	50
BC165	100	200	100	1450	50



Option :  
Sauna controller  
Model CX180S & CX180M

### Need Separate Controller

Code	Model	Power (kW)	Stone (kg)	Room Size (m <sup>3</sup> )	Room Height (cm)	Suitable With Controller	Retail Price	Code✘	
22600820125	BC105	10.5 kW / 3PH	40 - 50	9 - 15	190	CX180 M	42,700.00	B ★	
22600820130	BC135	13.5 kW / 3PH		11 - 20		CG170	46,800.00		
22600820135	BC165	16.5 kW / 3PH		16 - 30		CG170	51,000.00		
22600820140	ZSB-485	Air circulation grill for Vega Pro heaters						6,800.00	

✘✘ ราคาไม่รวมหิน / Excluded Stone

หมายเหตุ : ราคายังไม่รวมภาษี 7% บริษัทฯ ขอสงวนสิทธิ์ในการเปลี่ยนแปลงราคาโดยไม่ต้องแจ้งให้ทราบล่วงหน้า  
Remarks : Excluded VAT 7%. The Company reserves the right to change the prices without announcement.



# “HARVIA” Variant Sauna Rooms (1)

### STANDARD SAUNA CABIN INCLUDE

- Saunas are made in Muuram, Finland
- 6 sizes, all with glass walls
- Interior and exterior walls are made of spruce
- Benches are made of aspen

### NOT INCLUDE

- Sauna Heater
- Sauna Accessories
- Sauna Controller
- LED Lighting
- Sauna Stone

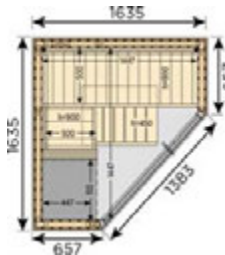

Code	Model	Name	Dimensions (mm)	Recommended Heater Power (kW)	Retail Price	Code✘
22610820175	S-1616-CV✘	Variant View Corner	1635 x 1635 x 2016	Max 6 kW	กรุณาติดต่อเจ้าหน้าที่ / Please Check with Sales Assistance	

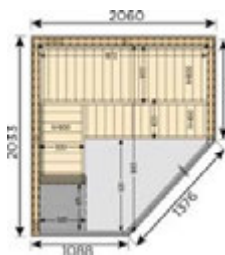

Code	Model	Name	Dimensions (mm)	Recommended Heater Power (kW)	Retail Price	Code✘
22610820180	S-2020-CV✘	Variant View Corner Large	2060 x 2033 x 2016	8 – 9 kW	กรุณาติดต่อเจ้าหน้าที่ / Please Check with Sales Assistance	

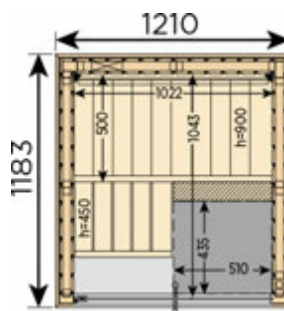

Code	Model	Name	Dimensions (mm)	Recommended Heater Power (kW)	Retail Price	Code✘
22610820185	S-1212-SV✘	Variant View Mini	1210 x 1183 x 2016	3.6 kW	กรุณาติดต่อเจ้าหน้าที่ / Please Check with Sales Assistance	

✘ สินค้าไม่มีสต็อก กรุณาลงสั่งซื้อล่วงหน้า / No Stock, Delivery Time : 60 - 90 Days

หมายเหตุ : ราคายังไม่รวมภาษี 7% บริษัทฯ ขอสงวนสิทธิ์ในการเปลี่ยนแปลงราคาโดยไม่ต้องแจ้งให้ทราบล่วงหน้า

Remarks : Excluded VAT 7%. The Company reserves the right to change the prices without announcement.



## “HARVIA” Variant Sauna Rooms (2)

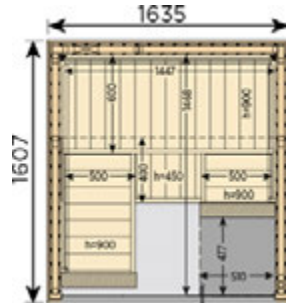

Code	Model	Name	Dimensions (mm)	Recommended Heater Power (kW)	Retail Price	Code✘
22610820190	S-1616-SV✘	Variant View Small	1635 x 1608 x 2016	6 kW	กรุณาติดต่อเจ้าหน้าที่ / Please Check with Sales Assistance	

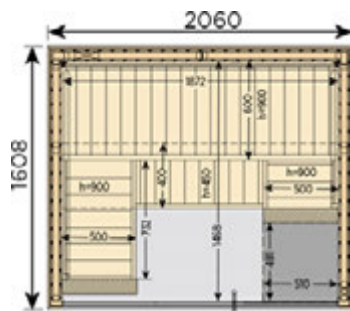

Code	Model	Name	Dimensions (mm)	Recommended Heater Power (kW)	Retail Price	Code✘
22610820195	S-1620-SV✘	Variant View Medium	2060 x 1608 x 2016	6 - 7 kW	กรุณาติดต่อเจ้าหน้าที่ / Please Check with Sales Assistance	

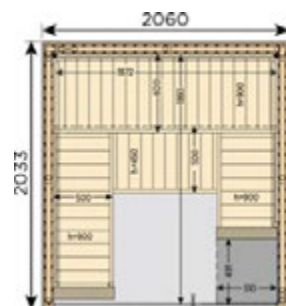

Code	Model	Name	Dimensions (mm)	Recommended Heater Power (kW)	Retail Price	Code✘
22610820200	S-2020-SV✘	Variant View Large	2060 x 2033 x 2016	8 - 9 kW	กรุณาติดต่อเจ้าหน้าที่ / Please Check with Sales Assistance	

✘ สินค้าไม่มีสต็อก กรุณาสั่งซื้อล่วงหน้า / No Stock, Delivery Time : 60 - 90 Days

หมายเหตุ : ราคายังไม่รวมภาษี 7% บริษัทฯ ขอสงวนสิทธิ์ในการเปลี่ยนแปลงราคาโดยไม่ต้องแจ้งให้ทราบล่วงหน้า  
Remarks : Excluded VAT 7%. The Company reserves the right to change the prices without announcement.

**HARVIA**



“HARVIA” Radiant Infrared Cabins

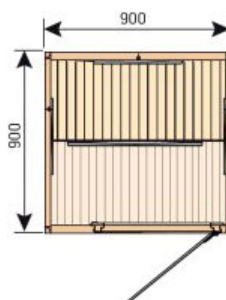
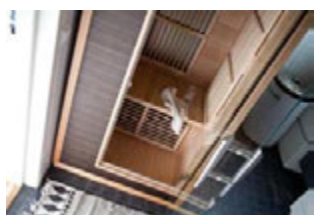

Code	Model	Name	Dimensions (mm)	Output (kW)	Fuse (A)	Retail Price	Code✘
22620820025	SGC-0909-BR ✘	Radiant Infra for 1 person	900 x 900 x 1910	1340 kW	10A	กรุณาติดต่อเจ้าหน้าที่ / Please Check with Sales Assistance	

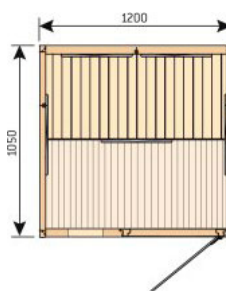

Code	Model	Name	Dimensions (mm)	Output (kW)	Fuse (A)	Retail Price	Code✘
22620820030	SGC-1210-BR ✘	Radiant Infra for 2 person	1200 x 1050 x 1910	1820 kW	10A	กรุณาติดต่อเจ้าหน้าที่ / Please Check with Sales Assistance	

✘ สินค้าไม่มีสต็อก กรุณาสั่งซื้อล่วงหน้า / No Stock, Delivery Time : 60 - 90 Days

หมายเหตุ : ราคายังไม่รวมภาษี 7% บริษัทฯ ขอสงวนสิทธิ์ในการเปลี่ยนแปลงราคาโดยไม่ต้องแจ้งให้ทราบล่วงหน้า  
 Remarks : Excluded VAT 7%. The Company reserves the right to change the prices without announcement.



# “HARVIA” Sauna Heater Controllers

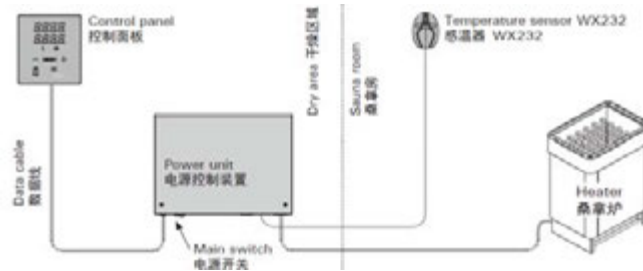

Code	Model	Max Power (kW)	Room Size (m <sup>3</sup> )	Retail Price	Code*
22640820030	CX180 S	2 - 8.0 kW	Relay Included Inside the Control Unit	26,200.00	B★
22640820035	CX180 M	9 - 16.5 kW		34,200.00	
22640820040	CX180 L	2.0 kW		39,900.00	

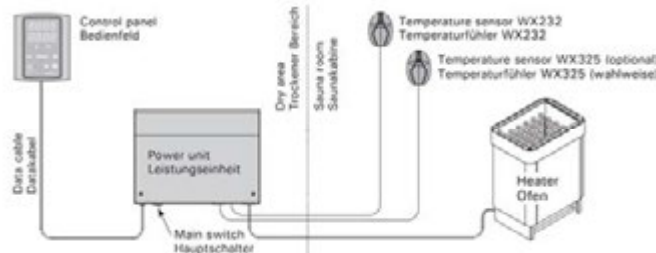
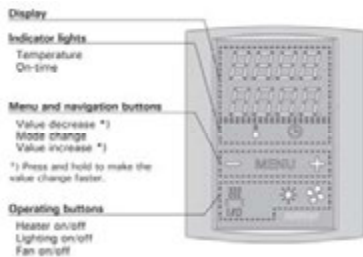

Code	Model	Max Power (kW)	Room Size (m <sup>3</sup> )	Retail Price	Code*
22640820005	CG170	17.0 kW	With Separate Relay	29,000.00	B★
22640820010	CG180	18.0 kW	Box	39,000.00	

## FEATURES

- Temperature adjustment range 40-110°C
- Operating time adjustment range:
  - Family sauna 1 – 6 hours
  - Commercial Sauna 1 – 12 hours
- Pre-setting time adjustment range 0 – 12 hours
- Lighting and fan control
- Maximum output 17 kW (can be extended to 34 kW with LTY17 power extension unit)
- Power unit supply 440 V 3N



### POWER UNIT

Each Harvia Xenio control unit comes with a power unit that is install in a dry place outside the sauna room

Code	Model	Name	Max Power (kW)	Size (cm)	Retail Price	Code*
22640820440	CX170400*	Xenio CX170	17 kW	Depth 2.4 x Width x 8.5 x Height 11	63,900.00	B

\* สินค้าไม่มีสต็อก กรุณาสั่งซื้อล่วงหน้า / No Stock, Delivery Time : 30 - 60 Days

หมายเหตุ : ราคายังไม่รวมภาษี 7% บริษัทฯ ขอสงวนสิทธิ์ในการเปลี่ยนแปลงราคาโดยไม่ต้องแจ้งให้ทราบล่วงหน้า  
Remarks : Excluded VAT 7%. The Company reserves the right to change the prices without announcement.



**HARVIA**

## Sauna Accessories (1)

Code	Model	Description	Retail Price	Code✘
22630820275	SACK08008 ✘	Speaker DL8ES Steel For Sauna Room, 30W, 8cm.		กรุณาติดต่อเจ้าหน้าที่ / Please Check with Sales Assistance
22630820270	WX440 ✘	Lighting Set With Transformer Length 2.5 Meters		กรุณาติดต่อเจ้าหน้าที่ / Please Check with Sales Assistance
22630820005	SAC10003	4 l Bucket with plastic pot	1,700.00	B ★
22630820010	SAC10107	7 l Bucket with plastic pot	2,800.00	
22630820170	SAC10101 ✘	Illuminated bucket 7 l	12,900.00	B ★
22630820175	SA006 ✘	Steel accessories set	9,900.00	B ★
22630820025	SAC10640	Ladle 36 cm	1,100.00	B ★
22630820180	SAC10650	Ladle 48 cm	1,300.00	
22630820185	SAC19800	Sandglass Lux	1,100.00	B ★
22630820035	SAC19900	Sandglass	900.00	B ★
22630820190	SAC92000	Thermometer	1,600.00	B ★
22630820195	SAC92200	Hygrometer	1,600.00	B ★



✘ สินค้าไม่มีสต็อก กรุณาสั่งซื้อล่วงหน้า / No Stock, Delivery Time : 30 - 60 Days

หมายเหตุ : ราคายังไม่รวมภาษี 7% บริษัทฯ ขอสงวนสิทธิ์ในการเปลี่ยนแปลงราคาโดยไม่ต้องแจ้งให้ทราบล่วงหน้า

Remarks : Excluded VAT 7%. The Company reserves the right to change the prices without announcement.



## Sauna Accessories (2)

Code	Model	Description	Retail Price	Code✘
22630820060	SAS92300	Thermo-/Hygrometer	2,000.00	B ★



Code	Model	Description	Retail Price	Code✘
22630820210	SAS24200	Ventilation Valve	420.00	B ★
22630820215	SAS24300	Ventilation Grill	420.00	



Code	Model	Description	Retail Price	Code✘
22630820220	SAS24250	Sauna Air Valve 100 mm , Pine Wood	1,300.00	B ★
22630820225	SAS24251	Sauna Air Valve 125 mm , Pine Wood	1,400.00	
22630820230	SAS24250C	Sauna Air Valve 100 mm , Cedar Wood	1,400.00	
22630820235	SAS24251C	Sauna Air Valve 125 mm , Cedar Wood	1,800.00	



Code	Model	Description	Retail Price	Code✘
22630820100	SAS21060	Sauna lamp (Exclude light bulb)	1,000.00	B ★
22630820240	SAS21060T	Sauna lamp EU Model (Exclude light bulb)	1,400.00	



Code	Model	Description	Retail Price	Code✘
22630820110	SAS21101	Lamp Shade	3,200.00	B ★
22630820245	SAS21103	Lamp Shade Lux	3,600.00	



Code	Model	Description	Retail Price	Code✘
22630820250	SAS21106	Sauna Light, Steel	4,200.00	B ★
22630820255	SAS21107	Sauna Light, Legend	4,200.00	



Code	Model	Description	Retail Price	Code✘
22630820135	SAS21061	Lamp globe, glass	420.00	B ★



Code	Model	Description	Retail Price	Code✘
22630820140	AC3000	Stones Packing 20 kgs	1,600.00	B ★
22630820265	AC3001	Stones Packing 10 kgs	1,200.00	



หมายเหตุ : ราคายังไม่รวมภาษี 7% บริษัทฯ ขอสงวนสิทธิ์ในการเปลี่ยนแปลงราคาโดยไม่ต้องแจ้งให้ทราบล่วงหน้า  
 Remarks : Excluded VAT 7%. The Company reserves the right to change the prices without announcement.

# HARVIA

## “HARVIA” Heated Benches

### THE WONDERFUL RELAXATION OF SITTING

Harvia Spa Modules offer an easy and effective way to implement the furnishings and structures of even the most demanding spa destinations. The manufacturing method can also be scaled down effectively for home steam rooms, spas and shower recesses – in almost any form imaginable.

### HARVIA SPA MODULES ARE

- Easy and quick to install
- Easy to modify
- Lightweight yet strong (with a structural strength comparable to concrete)
- Particularly effective at water insulation
- Comfortable to use (they warm up/cool down when in contact with the body much faster than concrete structures)
- Manufactured from extruded polystyrene (XPS)
- Ecological compared to concrete (manufacturing consumes less water and energy)

### READY-MADE – JUST ADD A SURFACE!

Harvia Spa Modules deliveries comprise wall, ceiling and seat structures as ready-to-install modules. After the modules have been installed, they are levelled and waterproofed. All the client has to do is select and purchase tiles and arrange for their installation.

### FOR USE IN SPAS, HOME SPAS, FITNESS CLUBS, WELLNESS CENTRES, HOTELS...

- Steam rooms
- Showers
- Cold rooms
- Poolside benches, swimming pools
- Furniture, such as recliners

Adjustable Temperature Range : 0-45°C

Normal Operating Temperature Range : 35-40°C

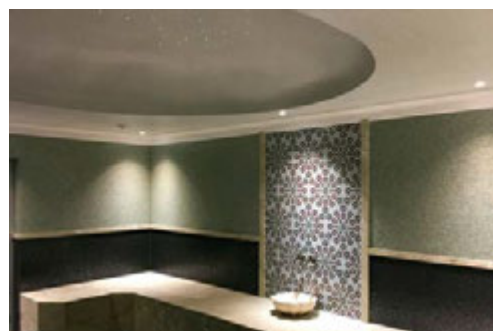
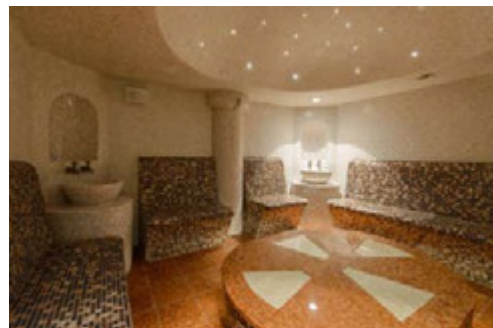

### A MAGNIFICENT STEAM ROOM EXPERIENCE FROM HARVIA

- Harvia Spa Modules structures
- Harvia HGX and HGP steam generators and accessories
- Aluminium door profiles
- Lighting products
- Steam fountains

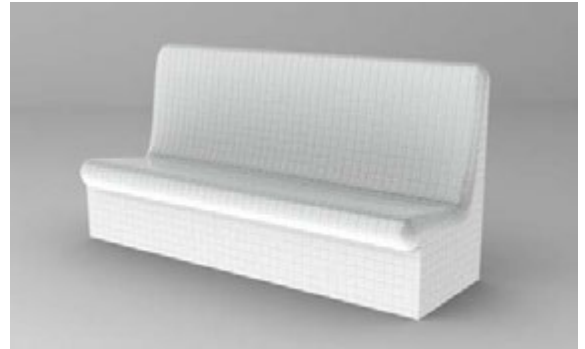

Code	Model	Name	Size	Retail Price	Code✘
22620820035	SM-BB✘	Basic Bench	Price for 1 meter	กรุณาติดต่อเจ้าหน้าที่ / Please Check with Sales Assistance	

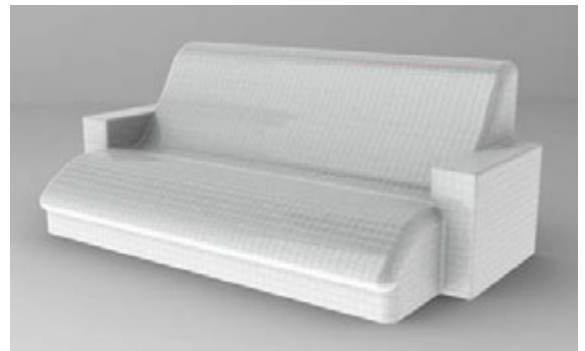
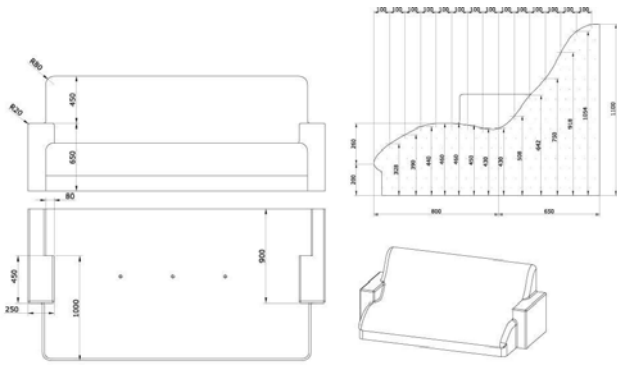

Code	Model	Name	Size	Retail Price	Code✘
22620820040	SM-BR✘	Bench - Relax	Price for 1 piece	กรุณาติดต่อเจ้าหน้าที่ / Please Check with Sales Assistance	

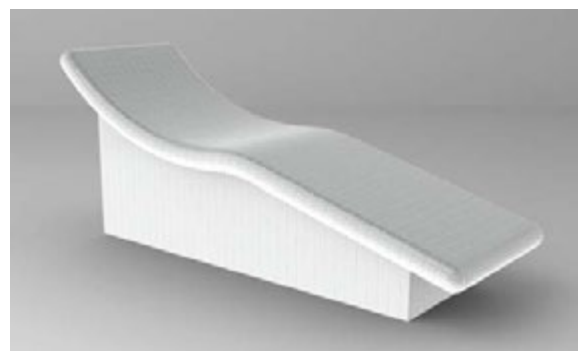
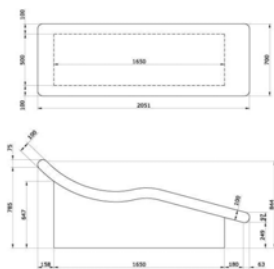

Code	Model	Name	Size	Retail Price	Code✘
22620820045	SM-BS✘	Bench - Sleep	Price for 1 piece	กรุณาติดต่อเจ้าหน้าที่ / Please Check with Sales Assistance	

✘ สินค้าไม่มีสต็อก กรุณาสั่งซื้อล่วงหน้า / No Stock, Delivery Time : 60 - 90 Days

หมายเหตุ : ราคายังไม่รวมภาษี 7% บริษัทฯ ขอสงวนสิทธิ์ในการเปลี่ยนแปลงราคาโดยไม่ต้องแจ้งให้ทราบล่วงหน้า  
Remarks : Excluded VAT 7%. The Company reserves the right to change the prices without announcement.



**AQUA FITNESS**





# “HYDRORIDER” AquaBike Easy Line Made In Italy

## HEALTH BENEFITS

- Effectively strengthen your leg muscles
- Increase speed capacity and power
- Eliminate cellulite & improve blood circulation
- Reinforce your cardiorespiratory capacity

## PRODUCT KEY FEATURES

- Light and steady
- Easy to use by all users
- Easy to take in and out of the pool



<b>Made In</b>	Italy; patented
<b>Material</b>	<ul style="list-style-type: none"> <li>- Structure: Marine Stainless Steel AISI 316L / rust proof</li> <li>- Bases: Double anti skid rubber protection</li> </ul>
<b>Weight</b>	19 kg
<b>Dimensions</b>	
<b>Length</b>	130 cm
<b>Width Base</b>	60 cm
<b>Height</b>	140 cm
<b>Recommended</b>	110-145 cm
<b>Pool Depth</b>	146-200cm with extensions
<b>Installation</b>	No specific installation is required. The equipment can easily be taken in and out of the pool.
<b>Type of Floor</b>	The equipment is safe on all type of floor: ceramic, mosaic, PVC...
<b>Maintenance</b>	The equipment does not required any special care. We recommend to periodically check the conditions of the spare parts and rinse with fresh water and towel dry them when taken out of the pool.
<b>Warranty</b>	2 years

**HANDLEBAR & SADDLE ADJUSTABLE**  
Moves upward and downward with an inclination that allows right alignment for different users height.



**RESISTANCE**  
Determined by two polygonal profiles under the pedals, designed to give continuous and constant resistance when pedaling. Resistance can also be improved increasing the pedaling speed.

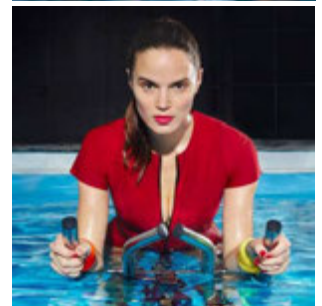

**LIGHT BUT VERY STABLE**  
The Aquabike is very light - only 19kg - but is very stable in water thanks to a large and robust stainless steel structure. The wheels on the front base of the bike make it very easy to put in and take out of the pool and move it on the pool deck.

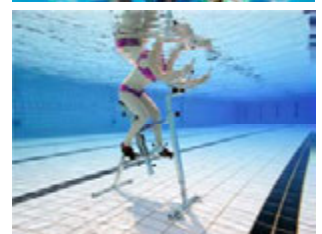

Code	Model	Description	Retail Price	Code✕
23620220010	DBS3006✕	Hydrorider AquaBike Easy Line With Standard Barefoot Pedals	199,000.00	A

✕ สินค้าไม่มีสต็อก กรุณาสั่งซื้อล่วงหน้า / No Stock, Delivery Time : 30 - 60 Days

หมายเหตุ : ราคายังไม่รวมภาษี 7% บริษัทฯ ขอสงวนสิทธิ์ในการเปลี่ยนแปลงราคาโดยไม่ต้องแจ้งให้ทราบล่วงหน้า  
Remarks : Excluded VAT 7%. The Company reserves the right to change the prices without announcement.



# “HYDRORIDER” AquaBike Professional Made In Italy

**ADVANTAGES**

- HANDLEBARS & SADDLE**

Adjustable both vertically and horizontally - fore and aft. For correct body positioning and targeted work – out experience. Handlebars are also reversible for additional posture options necessary in rehabilitation.
- PRO FLYWHEEL**

Different than the EASYLINE bike, our Professional AquaBike offers an innovative four elements pedal flywheel with pin rotation and synthetic self-lubricated bearing.
- RESISTANCE**

Variable settings for three grades of resistance, in addition to natural acceleration resistance.
- BASE**

covered with double anti ski rubber protection for better floor adhesion. Adjustable for pool depth and to account for any sloping. Safe on all types of pool floors including ceramic tile, mosaic, and PVC.



<b>Weight</b>	23 kg
<b>Dimensions</b>	
<b>Length</b>	130 cm
<b>Width Base</b>	60 cm
<b>Height</b>	140 cm
<b>Recommended</b>	110-145 cm
<b>Pool Depth</b>	146-200 cm
<b>Installation</b>	No specific installation is required. The equipment can easily be taken in and out of the pool.
<b>Type of Floor</b>	The equipment is safe on all type of floor: ceramic, mosaic, PVC...
<b>Maintenance</b>	The equipment does not require any special care. We recommend to periodically check the conditions of the base rubber protection, the pedal straps and the seats.

Code	Model	Description	Retail Price	Code✖
23620220170	DBS3001 ✖	Hydrorider Aquabike Professional	229,000.00	A

✖ สินค้าไม่มีสต็อก กรุณาสั่งซื้อล่วงหน้า / No Stock, Delivery Time : 30 - 60 Days

หมายเหตุ : ราคายังไม่รวมภาษี 7% บริษัทฯ ขอสงวนสิทธิ์ในการเปลี่ยนแปลงราคาโดยไม่ต้องแจ้งให้ทราบล่วงหน้า  
Remarks : Excluded VAT 7%. The Company reserves the right to change the prices without announcement.





# “HYDRORIDER” AquaTreadmill Easy Line Made In Italy

## HEALTH BENEFITS

- Strengthen your legs and core muscles
- Increase speed capacity and power
- Reinforce your cardiorespiratory capacity

## PRODUCT KEY FEATURES

- Robust and steady structure
- Foldable and easy to store
- Easy to take in and out of the pool



<b>Made In</b>	<b>Italy; patented</b>
<b>Type of Use</b>	Professional (fitness centres, public swimming pools, residential projects, rehabilitation...)
<b>Material</b>	- Structure: Marine Stainless Steel AISI 316L/rust proof - Platform: Acetal Copolymer - Bases: Double anti skid rubber
<b>Weight</b>	32 kg
<b>Dimensions</b>	
<b>Length</b>	120 cm (opened) - 55cm (folded)
<b>Width Base</b>	80 cm
<b>Height</b>	130 cm
<b>Recommended Pool Depth</b>	110-150 cm
<b>Installation</b>	No specific installation is required. The equipment can easily be taken in and out of the pool.
<b>Type of Floor</b>	The equipment is safe on all type of floor: ceramic, mosaic, PVC...
<b>Maintenance</b>	The equipment does not required any special care. We recommend to periodically check the conditions of the spare parts and rinse with fresh water and towel dry them when taken out of the pool.
<b>Warranty</b>	2 years

**308 INDEPENDENT ROLLS**  
Rotating rolls over a shock absorbing platform - Enable the natural and autonomous movement of both legs, allowing the user to move in respect with the body biomechanics. Users can also use the rolls for multiple exercises (walking, running, cross-skiing, moonwalk, etc.).



**RUNNING PLATFORM**  
The Shock Absorbing Running Platform guarantees an optimal fluency, and a stress free workout, also carries out an effective massage to the soles, activate the peripheal circulation stimulating the nerve endings.

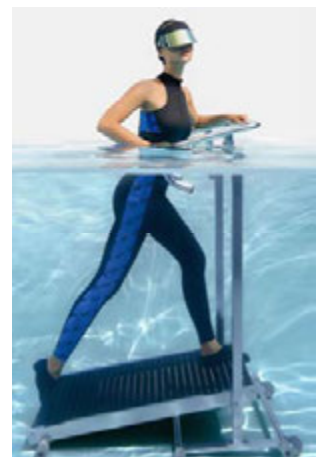

**ACTIVE LEG MOVEMENTS**  
Users don't have to follow a mechanically activated treadmill, but can freely move their own legs, walking and running, while sliding on the rollers and contrasting the resistance of water.

Code	Model	Description	Retail Price	Code✖
23620220005	DBS3004 ✖	Hydrorider AquaTreadmill Easy Line	239,000.00	A

✖ สินค้าไม่มีสต็อก กรุณาสั่งซื้อล่วงหน้า / No Stock, Delivery Time : 30 - 60 Days

หมายเหตุ : ราคายังไม่รวมภาษี 7% บริษัทฯ ขอสงวนสิทธิ์ในการเปลี่ยนแปลงราคาโดยไม่ต้องแจ้งให้ทราบล่วงหน้า  
Remarks : Excluded VAT 7%. The Company reserves the right to change the prices without announcement.



# “HYDRORIDER” Fow AquaFitness Mat

Similar to a surfboard, FOW is a floating and **rigid inflatable board** with an **anti-slip surface** that ensures the maximum stability.

FOW is a new dynamic way to perform Aquafitness. A complete exercise that allows users to improve posture, flexibility, balance, coordination and strength.

FOW offers a very intensive muscular activity. **Suitable for athletes, beginners and kids.** Chart your own course thru Fitness, Yoga, Pilates on water and explore the many possibilities for fun and energetic classes!



<b>Type of Use</b>	Home and Professional (fitness centres, public swimming pools, residential projects, rehabilitation...)
<b>Material</b>	- Structure: Nylon Reinforced PVC - Finish: Double layer drop-stitch technology
<b>Weight</b>	10 kg
<b>Dimensions</b>	
<b>Length</b>	200 cm
<b>Width Base</b>	80 cm
<b>Height</b>	10 cm
<b>Recommended</b>	100 cm
<b>Pool Depth</b>	
<b>Installation</b>	Comes with an installation kit
<b>Type of Pool</b>	The equipment can be used in swimming pools, the sea, lakes. It complies with the various specifications for aquatic use in chlorinated and saline environment.
<b>Maintenance</b>	No specific maintenance required. It is recommended a regular cleaning with fresh water.
<b>Warranty</b>	2 years

**FITNESS AND FUN!**  
This equipment allows you to enjoy the multiple benefits of water exercise, combined with coordination and fun: reduced stress, muscle relaxation, blood flow stimulation, and water massage. Jumping in water is very efficient and fun cardio training! You fight against resistance and do movements you can't do on land.



**SAFE AND STABLE**  
The trampoline is extremely stable allowing multiple exercises. Vulcanized rubber suction caps on the bases allow great adhesion and protection of the pool floor. The Shock-resistant rubber bumper ensures you can safely move the Aquajump with no risk for your pool.



**LIGHT AND EASY TO STORE**  
The Aquajump is light and very easy to move in and out of the pool. It can be stacked one on top of each other which makes it easy to store. It is the perfect equipment for private pool and commercial facilities. Children and adults love it.



Code	Model	Description	Retail Price	Code✘
23620220015	DBS3009✘	Hydrorider Fow AquaFitness Mat	กรุณาติดต่อเจ้าหน้าที่ / Please Check with Sales Assistance	

✘ สินค้าไม่มีสต็อก กรุณาสั่งซื้อล่วงหน้า / No Stock, Delivery Time : 30 - 60 Days

หมายเหตุ : ราคายังไม่รวมภาษี 7% บริษัทฯ ขอสงวนสิทธิ์ในการเปลี่ยนแปลงราคาโดยไม่ต้องแจ้งให้ทราบล่วงหน้า  
Remarks : Excluded VAT 7%. The Company reserves the right to change the prices without announcement.



# “HYDRORIDER” AquaJump

The Hydrorider Diamond Aquajump is a professional trampoline produced with excellent materials, starting from the 316L stainless steel frame, and with an innovating design specifically conceived for pool facilities.

This equipment allows you to enjoy the multiple benefits of water exercise, combined with coordination and fun: reduced stress, muscle relaxation, blood flow stimulation, and water massage.

Thanks to these advantages you can get great results in terms of physical training, weight loss, body balance, tonification and rehabilitation.



<b>Type of Use</b>	Home and Professional (fitness centres, public swimming pools, residential projects, rehabilitation...)
<b>Material</b>	- Structure: Nylon Reinforced PVC - Finish: Double layer drop-stitch technology
<b>Weight</b>	10 kg
<b>Dimensions</b>	
<b>Length</b>	200 cm
<b>Width Base</b>	80 cm
<b>Height</b>	10 cm
<b>Recommended Pool Depth</b>	100 cm
<b>Installation</b>	Comes with an installation kit
<b>Type of Pool</b>	The equipment can be used in swimming pools, the sea, lakes. It complies with the various specifications for aquatic use in chlorinated and saline environment.
<b>Maintenance</b>	No specific maintenance required. It is recommended a regular cleaning with fresh water.
<b>Storage</b>	The AquaJump needs a very reduced storage space. The AquaJump can be stacked one on top of each other which makes it easy to store.
<b>Warranty</b>	2 years

**FITNESS AND FUN!**

This equipment allows you to enjoy the multiple benefits of water exercise, combined with coordination and fun: reduced stress, muscle relaxation, blood flow stimulation, and water massage. Jumping in water is very efficient and fun cardio training! You fight against resistance and do movements you can't do on land.



**SAFE AND STABLE**

The trampoline is extremely stable allowing multiple exercises. Vulcanized rubber suction caps on the bases allow great adhesion and protection of the pool floor. The Shock-resistant rubber bumper ensures you can safely move the AquaJump with no risk for your pool.



**LIGHT AND EASY TO STORE**

The AquaJump is light and very easy to move in and out of the pool. It can be stacked one on top of each other which makes it easy to store. It is the perfect equipment for private pool and commercial facilities. Children and adults love it.



Code	Model	Description	Retail Price	Code✖
23620220020	DBS3007✖	Hydrorider AquaJump	กรุณาติดต่อเจ้าหน้าที่ / Please Check with Sales Assistance	

✖ สินค้าไม่มีสต็อก กรุณาสั่งซื้อล่วงหน้า / No Stock, Delivery Time : 30 - 60 Days

หมายเหตุ : ราคายังไม่รวมภาษี 7% บริษัทฯ ขอสงวนสิทธิ์ในการเปลี่ยนแปลงราคาโดยไม่ต้องแจ้งให้ทราบล่วงหน้า  
Remarks : Excluded VAT 7%. The Company reserves the right to change the prices without announcement.

# POOL SURROUNDING & COVERED





**SUNNY DAYS AHEAD**

Make the most of your favorite outdoor space. Shop our high-quality in-pool and outdoor furniture, stylish accessories, and exciting games to live your best outdoor life.



**MADE IN THE U.S.A.**

From concept to design to manufacturing, every Ledge Lounger product is made with pride in the United States of America.



**UV RESISTANT RESIN**

Our fade-resistant in-pool furniture is rated UV16, which means it will last 16,000 hours in direct overhead sunlight (that means 10+ years of fade resistance)\*



**COMMERCIAL GRADE**

The same furniture you put in your backyard is also at high-end resorts around the world. That's because we use materials that are made to last.



**HIGHLY CUSTOMIZABLE**

Your home doesn't look like your neighbors, and neither should your pool. Customize your furniture with unique colors, embroidery, and engraving.



# “LEDGE LOUNGER” Seats (1)

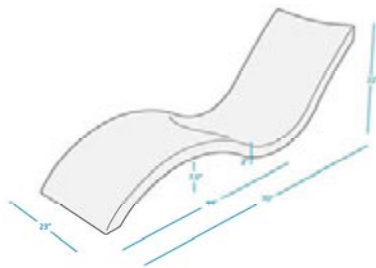
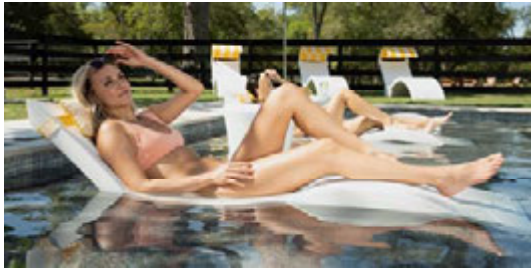

Made in the usa



High quality, in-water furniture



Commercial or Residential use



Customizable Options



Uv16 rated resin

Code	Model	Description	Dimensions (cm)	Retail Price	Code✖
23620220025	LL-SG-C-W	In-Pool Furniture Model Signature Chaise	W 58.42 x L 177.80 x H 55.88 cm Design for use in up to 22.86 cm of water	50,900.00	A

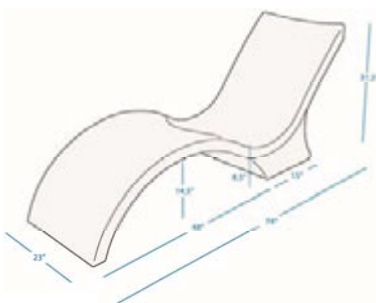
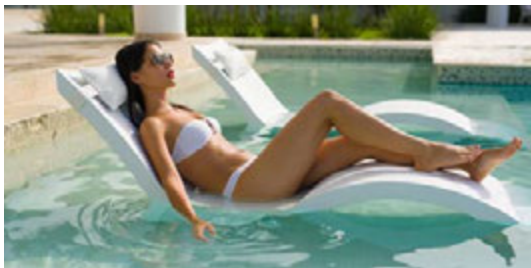

Made in the usa



High quality, in-water furniture



Commercial or Residential use



Customizable Options



Uv16 rated resin

Code	Model	Description	Dimensions (cm)	Retail Price	Code✖
23620220030	LL-SG-CD-W	In-Pool Furniture Model Signature Chaise Deep	W 58.42 x L 187.96 x H 80.01 cm Design for use in up to 38.10 cm of water	54,900.00	A

หมายเหตุ : ราคายังไม่รวมภาษี 7% บริษัทฯ ขอสงวนสิทธิ์ในการเปลี่ยนแปลงราคาโดยไม่ต้องแจ้งให้ทราบล่วงหน้า  
Remarks : Excluded VAT 7%. The Company reserves the right to change the prices without announcement.



## “LEDGE LOUNGER” Seats (2)

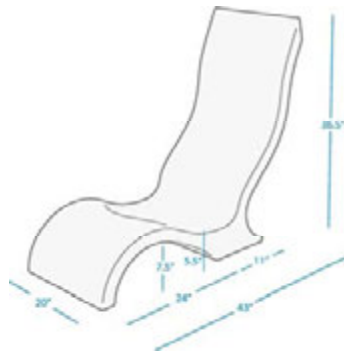

Made in the usa



High quality, in-water furniture



Commercial or Residential use



Customizable Options



Uv16 rated resin

Code	Model	Description	Dimensions (cm)	Retail Price	Code✘
23620220035	LL-SG-CR-W	In-Pool Furniture Model Signature Chair	W 50.80 x L 109.22 x H 92.71 cm Design for use in up to 22.86 cm of water	43,900.00	A

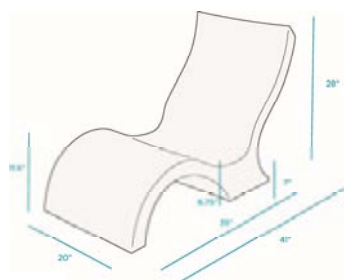

Made in the usa



High quality, in-water furniture



Commercial or Residential use



Customizable Options



Uv16 rated resin

Code	Model	Description	Dimensions (cm)	Retail Price	Code✘
23620220040	LL-SG-LBCR-W	In-Pool Furniture Model Signature Chair Lowerback	W 50.80 x L 104.14 x H 71.12 cm, Design for use in up to 22.86 cm of water	39,900.00	A

หมายเหตุ : ราคายังไม่รวมภาษี 7% บริษัทฯ ขอสงวนสิทธิ์ในการเปลี่ยนแปลงราคาโดยไม่ต้องแจ้งให้ทราบล่วงหน้า

Remarks : Excluded VAT 7%. The Company reserves the right to change the prices without announcement.



# “LEDGE LOUNGER” Barstools

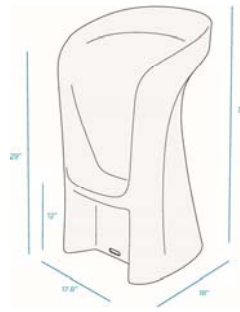

Made in the usa

High quality, in-water furniture

Commercial or Residential use

Customizable Options

Uv16 rated resin

Code	Model	Description	Dimensions (cm)	Retail Price	Code✘
23620220045	LL-SG-BS-42-W	In-Pool Furniture Model Signature Barstool	W 42.21 x L 45.72 x H 83.82 cm Design for water level at 90 cm	37,900.00	A

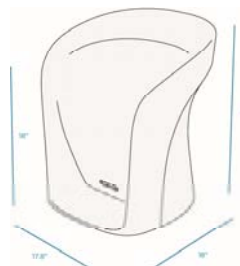
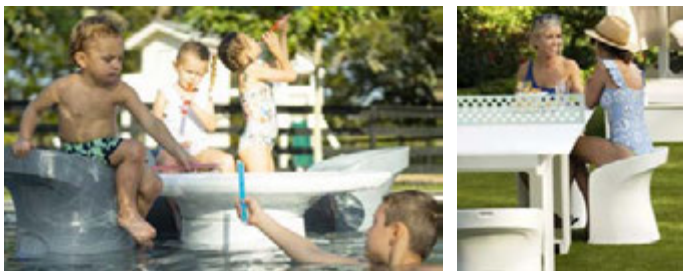

Made in the usa

High quality, in-water furniture

Commercial or Residential use

Customizable Options

Uv16 rated resin

Code	Model	Description	Dimensions (cm)	Retail Price	Code✘
23620220050	LL-SG-BS-30-W✘	In-Pool Furniture Model Signature Barstool Counter Heigh	W 42.21 x L 45.72 x H 54.61 cm Design for water level at 76 cm	35,900.00	A

✘ สินค้าไม่มีสต็อก กรุณาลังซื้อล่วงหน้า / No Stock, Delivery Time : 90 - 120 Days

หมายเหตุ : ราคายังไม่รวมภาษี 7% บริษัทฯ ขอสงวนสิทธิ์ในการเปลี่ยนแปลงราคาโดยไม่ต้องแจ้งให้ทราบล่วงหน้า  
Remarks : Excluded VAT 7%. The Company reserves the right to change the prices without announcement.





# “LEDGE LOUNGER” Sunbeds



Made in the usa



High quality, in-water furniture



Commercial or Residential use



Cutomizable Options



Uv16 rated resin

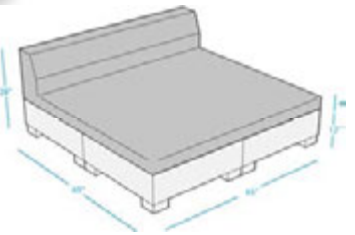

Code	Model	Description	Dimensions (cm)	Retail Price	Code✘
23620220055	LL-AF-SB-66SQ-BCSET ✘	In-Pool Furniture Model Affinity Square Sunbed with Backrest Cushion (Standard Fabric)	W 165.10 x L 165.10 x H 40.64 (Backrest 71.12) cm. Design for use in up to 25.40 cm of water	กรุณาติดต่อเจ้าหน้าที่ / Please Check with Sales Assistance	



Made in the usa



High quality, in-water furniture



Commercial or Residential use



Cutomizable Options



Uv16 rated resin

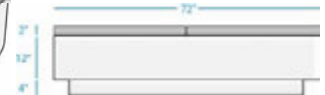
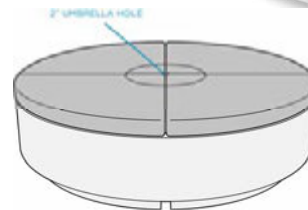

Code	Model	Description	Dimensions (cm)	Retail Price	Code✘
23620220060	LL-SG-SB-6RD-SET ✘	In-Pool Furniture Model Signature Round Sunbed (Base + Cushion)	Dia 182.88 x H 45.82 cm. Design for use in up to 30.48 cm of water	กรุณาติดต่อเจ้าหน้าที่ / Please Check with Sales Assistance	

✘ สินค้าไม่มีสต็อก กรุณาสั่งซื้อล่วงหน้า / No Stock, Delivery Time : 90 - 120 Days

หมายเหตุ : ราคายังไม่รวมภาษี 7% บริษัทฯ ขอสงวนสิทธิ์ในการเปลี่ยนแปลงราคาโดยไม่ต้องแจ้งให้ทราบล่วงหน้า  
Remarks : Excluded VAT 7%. The Company reserves the right to change the prices without announcement.



# “LEDGE LOUNGER” Laze Pillows



The Laze Pillow is not your average pool toy. When bean bag meets pool float, you’re definitely in for a treat. Skip the hassle of inflating and relax anywhere your pillow fits. Just unbox and lay. Whether floating in the pool or spending quality time with family on the lawn, the Laze Pillow provides the quality comfort you never knew you needed.

Grab your favorite look for the season and switch it out whenever you want a change. With multiple limited-edition patterns to choose from, you’ll always be on-trend

### FEATURES

- Absolute comfort
- Versatile use
- Machine washable
- Bleachable fabric
- Interchangeable covers



Made in the usa



High quality, in-water furniture



Commercial or Residential use



Customizable Options



Uv16 rated resin



Shibori Blue



Coral Floral



Boho Strip

Code	Model	Description	Colour	Retail Price	Code ✖
23620220155	LL-LZ-P-SHB	Laze Pillow Size L172.72 x W111.76 cm	Shibori Blue	43,900.00	A
23620220160	LL-LZ-P-CLF		Coral Floral	43,900.00	
23620220165	LL-LZ-P-BHS		Boho Strip	43,900.00	

หมายเหตุ : ราคายังไม่รวมภาษี 7% บริษัทฯ ขอสงวนสิทธิ์ในการเปลี่ยนแปลงราคาโดยไม่ต้องแจ้งให้ทราบล่วงหน้า  
Remarks : Excluded VAT 7%. The Company reserves the right to change the prices without announcement.



# “LEDGE LOUNGER” Accessory for Seats (1)



Made in the usa High quality.



Commercial or Residential use Customizable Options



Uv16 rated resin

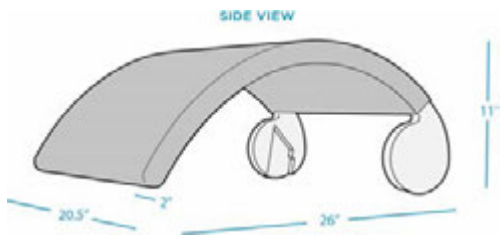

### FEATURES

- Designed for use with the Signature Chair
- Easy slide on, slide off installation via interior grooves
- Customizable fabric colors and embroidery upgrades

Code	Model	Description	Retail Price	Code✕
23620220065	LL-SG-CR-SH-FA-STD-4630 Cadet Gray ✕	Accessory for Seats, Signature Shade for Chair, STD Fabric 4630 Cadet Gray	28,900.00	A
23620220070	LL-SG-C-SH-FR-W ✕	Accessory for Seats, Signature Shade for Chair, Deep Shade Frame White Colour		



Made in the usa High quality.



Commercial or Residential use Customizable Options



Uv16 rated resin

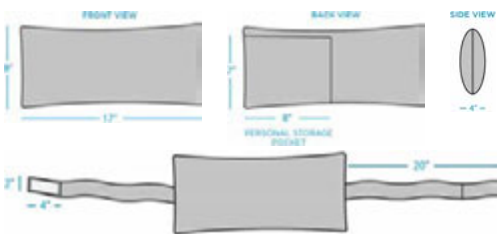

### FEATURES

- Designed for use with the Signature Chair
- Easy slide on, slide off installation via interior grooves
- Customizable fabric colors and embroidery upgrades

Code	Model	Description	Retail Price	Code✕
23620220075	LL-SG-C-P-STD-4630 Cadet Gray ✕	Accessory for Seats, Signature Chaise Headrest Pillow	8,900.00	A

✕ สินค้าไม่มีสต็อก กรุณาสั่งซื้อล่วงหน้า / No Stock, Delivery Time : 90 - 120 Days

หมายเหตุ : ราคายังไม่รวมภาษี 7% บริษัทฯ ขอสงวนสิทธิ์ในการเปลี่ยนแปลงราคาโดยไม่ต้องแจ้งให้ทราบล่วงหน้า  
Remarks : Excluded VAT 7%. The Company reserves the right to change the prices without announcement.



# “LEDGE LOUNGER” Accessory for Seats (2)

## FEATURES

- Designed for out of water use with the Signature Chaise
- Perfect for residential or commercial use
- Crafted out of high-quality, marine-grade outdoor fabrics and EZ-Dri foam core
- Built to withstand sun, weather, and chemicals of any pool or outdoor environment
- Easily secured with velcro attachment
- Features a built-in pillow and personal storage pocket



### HEADREST PILLOW

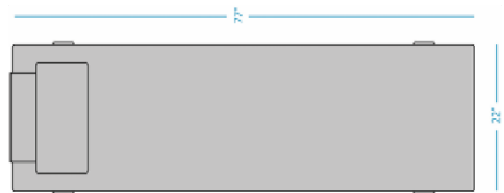
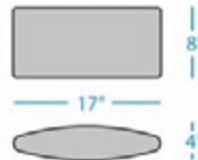

Code	Model	Description	Retail Price	Code✕
23620220080	LL-SG-CD-C-STD-4630 Cadet Gray ✕	Accessory for Seats, Signature Chaise Cushion, STD Fabric, 4630 Cadet Gray	25,900.00	A

## FEATURES

- Designed for out of water use with the Signature Chaise Deep
- Perfect for residential or commercial use
- Crafted out of high-quality, marine-grade outdoor fabrics and EZ-Dri foam core
- Built to withstand sun, weather, and chemicals of any pool or outdoor environment
- Easily secured with velcro attachment
- Features a built-in pillow and personal storage pocket



### HEADREST PILLOW

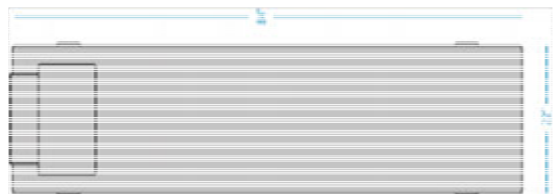
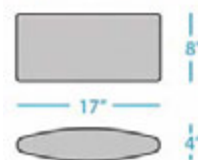

Code	Model	Description	Retail Price	Code✕
23620220085	LL-SG-CD-CP-STD-4630 Cadet Gray ✕	Accessory for Seats, Signature Chaise Deep Cushion, STD Fabric, 4630 Cadet Gray	28,900.00	A

✕ สินค้าไม่มีสต็อก กรุณาสั่งซื้อล่วงหน้า / No Stock, Delivery Time : 90 - 120 Days

หมายเหตุ : ราคายังไม่รวมภาษี 7% บริษัทฯ ขอสงวนสิทธิ์ในการเปลี่ยนแปลงราคาโดยไม่ต้องแจ้งให้ทราบล่วงหน้า  
 Remarks : Excluded VAT 7%. The Company reserves the right to change the prices without announcement.



# “LEDGE LOUNGER” Accessory for Seats (3)



Made in the usa



High quality, in-water furniture



Commercial or Residential use



Cutomizable Options



Uv16 rated resin

Code	Model	Description	Retail Price	Code✖
23620220090	LL-SG-C-RISER->9-12 ✖	Signature Riser for Chaise Size 9"-12" (22.86 - 30.48 cm)	9,900.00	A
23620220095	LL-SG-C-RISER->12-14 ✖	Signature Riser for Chaise Size 12"-14" (30.48 - 35.56 cm)	10,900.00	
23620220100	LL-SG-C-RISER->14-15.5 ✖	Signature Riser for Chaise Size 14"-15.5" (35.56 - 39.37 cm)	10,900.00	

✖ สินค้าไม่มีสต็อก กรุณาลังซื้อล่วงหน้า / No Stock, Delivery Time : 90 - 120 Days

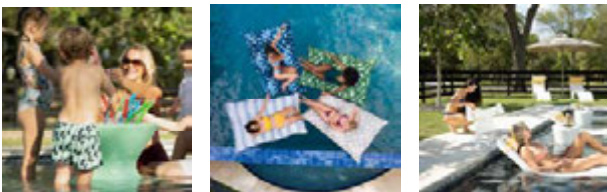
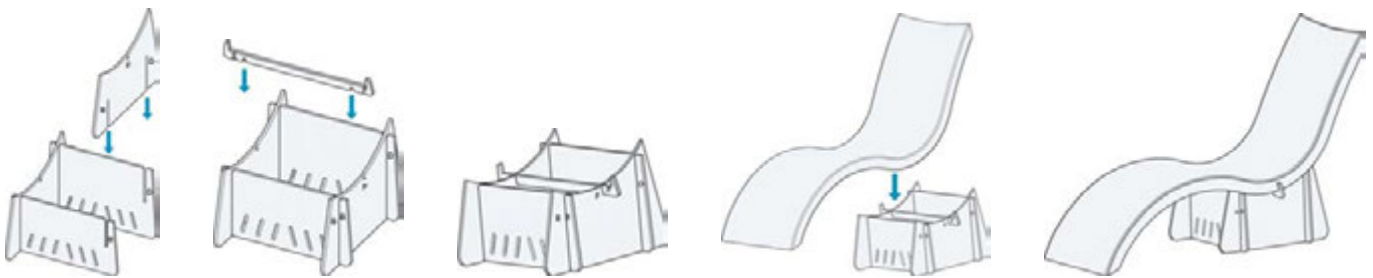

หมายเหตุ : ราคายังไม่รวมภาษี 7% บริษัทฯ ขอสงวนสิทธิ์ในการเปลี่ยนแปลงราคาโดยไม่ต้องแจ้งให้ทราบล่วงหน้า  
Remarks : Excluded VAT 7%. The Company reserves the right to change the prices without announcement.



# “LEDGE LOUNGER” Tables (1)

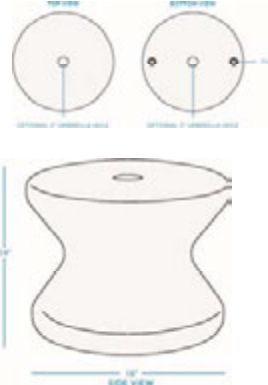

Made in the usa



High quality, in-water furniture



Commercial or Residential use



Customizable Options



Uv16 rated resin

Code	Model	Description	Dimensions (cm)	Retail Price	Code✕
23620220130	LL-SG-ST-14NL-W	In-Pool Furniture Model Signature 14” Side Table with umbrella hole	W Dia 45.72 x H 35.56 cm Design for use in up to 25.40 cm of water	24,900.00	A

Code	Model	Description	Dimensions (cm)	Retail Price	Code✕
23620220135	LL-SG-ST-22NL-W	In-Pool Furniture Model Signature 22” Side Table with umbrella hole	W 42.21 x L 45.72 x H 54.61 cm Design for on-pool or on-deck	28,900.00	A

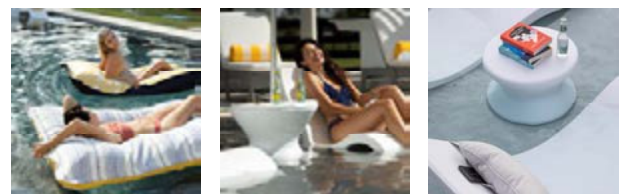

หมายเหตุ : ราคายังไม่รวมภาษี 7% บริษัทฯ ขอสงวนสิทธิ์ในการเปลี่ยนแปลงราคาโดยไม่ต้องแจ้งให้ทราบล่วงหน้า  
Remarks : Excluded VAT 7%. The Company reserves the right to change the prices without announcement.



## “LEDGE LOUNGER” Tables (2)

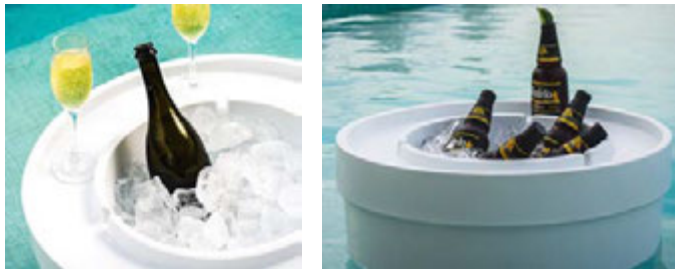

Made in the usa

High quality, in-water furniture

Commercial or Residential use

Customizable Options

Uv16 rated resin

Code	Model	Description	Dimensions (cm)	Retail Price	Code✕
23620220140	LL-SG-IB-W	In-Pool Furniture Model Signature Ice Bin Side Table with lid	W Dia 55.88 x H 50.80 cm. Design for use in up to 38.10 cm of water	28,900.00	A



Made in the usa

High quality, in-water furniture

Commercial or Residential use

Customizable Options

Uv16 rated resin

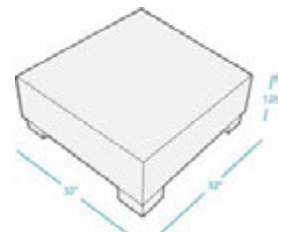

Code	Model	Description	Dimensions (cm)	Retail Price	Code✕
23620220145	LL-SG-CT✕	In-Pool Furniture Model Signature Coffee Table	W 68.58 x L 139.70 x H 55.88 cm, Design for use in up to 30.48 cm of water	36,900.00	A

✕ สินค้าไม่มีสต็อก กรุณาสั่งซื้อล่วงหน้า / No Stock, Delivery Time : 90 - 120 Days

หมายเหตุ : ราคายังไม่รวมภาษี 7% บริษัทฯ ขอสงวนสิทธิ์ในการเปลี่ยนแปลงราคาโดยไม่ต้องแจ้งให้ทราบล่วงหน้า  
Remarks : Excluded VAT 7%. The Company reserves the right to change the prices without announcement.



# “LEDGE LOUNGER” Slides

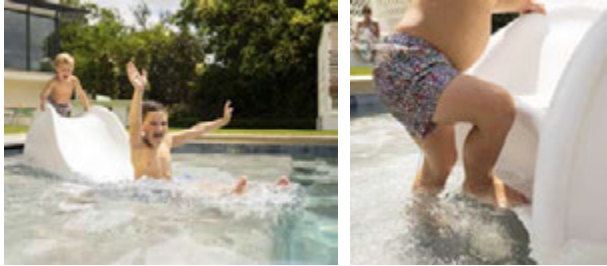

Made in the usa



High quality, in-water furniture



Commercial or Residential use



Customizable Options



Uv16 rated resin

Code	Model	Description	Dimensions (cm)	Retail Price	Code✕
23620220150	LL-SG-SLD	In-Pool Furniture Model Signature Slide	W 68.58 x L 139.70 x H 55.88 cm, Design for use in up to 30.48 cm of water	43,900.00	A

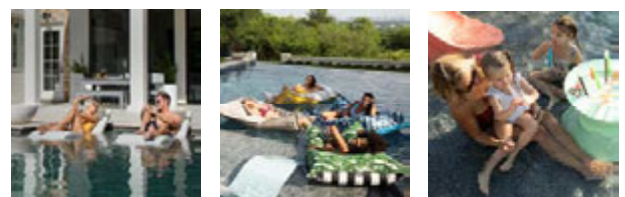

หมายเหตุ : ราคายังไม่รวมภาษี 7% บริษัทฯ ขอสงวนสิทธิ์ในการเปลี่ยนแปลงราคาโดยไม่ต้องแจ้งให้ทราบล่วงหน้า  
Remarks : Excluded VAT 7%. The Company reserves the right to change the prices without announcement.





# “REMCO” PoolGuard Pool Covers System Made In Australia

The latest innovation in swimming pool safety and the perfect cover for new or existing pools is PoolGuard. Not only is it durable multifunctional cover, but it can also withstand a load of up to 100 kg, providing outstanding safety for children and pets. PoolGuard seals the pool completely allowing quick and easy removal of leaves and debris before swimming.

- Safety
- Clean
- Custom Fitted
- Insulates & Heats
- Retractable Anchor System
- Increases efficiency & saves water

### MANUAL OPERATION

PoolGuard pool covers are available with geared manual winders. No large unsightly roller mechanisms! Manual winder gear ratios are carefully selected to suit each individual cover size and therefore a simple roll-up process.



MANUAL WINDER OPTIONS

### MOTOR-ASSISTED OPERATION

For complete ease of use, and a quick roll-up time, a high powered motor-assisted winder is also available – perfect for pools over 32m<sup>2</sup>.



MOTOR-ASSISTED WINDER



### SECURING POOLGUARD

Securing your PoolGuard cover is easy. Simply attach the strap to the retractable anchor.



STEP 1

Tighten and lock the strap to ensure your cover is safely secured.



STEP 2



Code	Model	Colour	Retail Price	Code✘
22211700010	Pool Guard✘	Blue / Cream / Green / Gray	กรุณาติดต่อเจ้าหน้าที่ / Please Check with Sales Assistance	

✘ สินค้าไม่มีสต็อก กรุณาสั่งซื้อล่วงหน้า / No Stock, Delivery Time : 90 - 120 Days

หมายเหตุ : ราคายังไม่รวมภาษี 7% บริษัทฯ ขอสงวนสิทธิ์ในการเปลี่ยนแปลงราคาโดยไม่ต้องแจ้งให้ทราบล่วงหน้า  
Remarks : Excluded VAT 7%. The Company reserves the right to change the prices without announcement.

# WARRANTY



# การรับประกันสินค้า EMAUX

## บทนำ

เงื่อนไขการรับประกันในหนังสือรับประกันฉบับนี้แทนที่เงื่อนไขในหนังสือรับประกันก่อนหน้านี้ที่ทุกฉบับของ Emaux Water Technology Co., Ltd. "Emaux" เป็นผู้ผลิตผลิตภัณฑ์ที่มีมาตรฐานสูงสุดในการผลิตโดยใช้วัสดุที่ดีที่สุดผ่านกระบวนการที่ทันสมัย "Emaux" ภูมิใจเสนอการรับประกันผลิตภัณฑ์ดังนี้

## การรับประกันเฉพาะสินค้า (ตั้งแต่วันที่ออกใบแจ้งรายการสินค้า)

สินค้า	ระยะเวลาการรับประกัน
<b>เครื่องกรอง</b>	
MFV & MFS & T P & PS	ถังกรอง 5 ปี / ชิ้นส่วนอื่น ๆ ทั้งหมด 1 ปี
V, S, SR, SD, LF & HD	ถังกรอง 3 ปี / ชิ้นส่วนอื่น ๆ ทั้งหมด 1 ปี
TMG & SMG	Pro-Rata* - ถังกรอง 5 ปี / ชิ้นส่วนอื่น ๆ ทั้งหมด 1 ปี
<b>เครื่องกรองเพื่อการพาณิชย์</b>	
NL, E, H & K	Pro-Rata* - ถังกรอง 5 ปี / ชิ้นส่วนอื่น ๆ ทั้งหมด 1 ปี
<b>ปั๊ม</b>	
EPV, EPH, SPV & SPH	3 ปี (Variable Speed Driver 2 ปี / ซีล & โอริง 1 ปี)
SB, SR, SS	2 ปี (ซีล & โอริง 1 ปี)
SD, ST, AquaMini	1 ปี
C-SE, Hydrau-Power	3 ปี (ซีล & โอริง 1 year)
SWP	Pro-Rata* 5 ปี (ซีล & โอริง 1 year)
Mechanical	1 ปี (อะไหล่ซ่อมรับประกัน 3 เดือน) / กรณีเสียคนจะจุดกับจุดเดิมไม่รับประกัน (คิดค่าซ่อมแซม)
<b>ระบบฆ่าเชื้อ</b>	
Nano-Tech UV-C, MPUV & FOS	2 ปี (Lamp & Sleeve 1 ปี)
Salt Chlorinator	2 ปี
Ozo-Plus Ozone Generator OZG-4G & OZG-8G	2 ปี
CL, CLL	1 ปี
CTRL	2 ปี (เซ็นเซอร์ 1 ปี)
ไฟได้น้ำ	1 ปี
อุปกรณ์ประกอบ	1 ปี
ระบบทำความร้อน	1 ปี
WHITE GOODS	1 ปี
อุปกรณ์ทำความสะอาด	1 ปี
อื่น ๆ	1 ปี

\*หมายเหตุ : Pro-Rata = 3 ปีเต็ม , ปีที่ 4 : 50% , ปีที่ 5 : 30%

## กระบวนการเคลม

กระบวนการเคลมของ Emaux มี 3 ขั้นตอนดังนี้ :-

- การเรียกร้องการรับประกัน: ติดต่อกับตัวแทนจำหน่ายหรือพนักงานขายของ Emaux และแจ้งรายละเอียดทั้งหมดเกี่ยวกับการเคลม ซึ่งรวมถึง :
  - ข้อมูลเกี่ยวกับผลิตภัณฑ์ที่มีปัญหา หรือ เสียหาย เช่น หมายเลขชิ้นส่วนผลิตภัณฑ์ และหมายเลข ผลิตภัณฑ์
  - คำอธิบายปัญหา หรือความเสียหาย
  - รูปภาพที่เกี่ยวข้อง
- เมื่อรับเรื่องเคลมแล้ว แผนกคุณภาพของ Emaux จะทำการตรวจสอบตาม "นโยบายการรับประกันของ Emaux" ในแค็ตตาล็อกผลิตภัณฑ์ Emaux 2019
- หลังจากการตรวจสอบเสร็จสิ้น Emaux จะแจ้งผู้จัดจำหน่ายผลิตภัณฑ์ดังกล่าวและติดตามผลกลับลูกค้าตามลำดับ

**การรับประกันนี้จะไม่ครอบคลุมในกรณีดังต่อไปนี้: -**

1. ความเสียหายที่เกิดจากการกระทำโดยประมาท การบรรจุหรือจัดส่งที่ไม่ถูกต้อง
2. ความเสียหายที่เกิดจากการใช้งานผิดวิธี ผิดวัตถุประสงค์หรือใช้งานไม่ได้จากการติดตั้ง และการติดตั้งอุปกรณ์ไม่เป็นไปตามที่ระบุไว้ในคู่มือการใช้งาน.
3. ความเสียหายที่เกิดจากการใช้ผิดประเภท การใช้ผิดวิธีผิดวัตถุประสงค์หรือใช้งานผิดพลาดและการติดตั้งอุปกรณ์เกินขอบเขต ความสามารถของอุปกรณ์ที่ต้องการหรือรูปแบบการติดตั้งที่คล้ายคลึงกัน.
4. ความเสียหายที่เกิดจากการดัดแปลงผลิตภัณฑ์โดยไม่ได้รับอนุญาตหรือไม่สามารถใช้อะไหล่แท้จาก Emaux ทดแทนของเดิมได้
5. ความเสียหายที่เกิดจากความประมาทหรือความล้มเหลวในการบำรุงรักษาผลิตภัณฑ์อย่างถูกต้องตามที่ระบุไว้ในคู่มือการใช้งาน
6. ความเสียหายที่เกิดจากความล้มเหลวในการรักษาสภาพน้ำให้สอดคล้องกับมาตรฐานของอุตสาหกรรมสระว่ายน้ำเป็นระยะเวลาหนึ่ง
7. ความเสียหายที่เกิดจากการแข่งภายในตัวเครื่อง
8. ความเสียหายจากอุบัติเหตุ ไฟไหม้หรือเหตุอื่นที่อยู่นอกการควบคุมของ Emaux
9. การดัดแปลงแก้ไขหรือซ่อมแซมอย่างใดอย่างหนึ่งกับชิ้นส่วนของผลิตภัณฑ์โดยบุคคลที่ไม่ได้รับอนุญาตจาก Emaux.
10. ชิ้นส่วนสึกหรอ หรือ ฉีกขาด
11. ความเสียหายที่เกิดจากการทำงานผิดปกติของกระแสไฟฟ้า ก๊าซพิษติดตามธรรมชาติ หรือ สงคราม

**ความรับผิดชอบของ Emaux ต่อผลิตภัณฑ์**

Emaux รับประกันว่าผลิตภัณฑ์ของบริษัทเป็นวัสดุที่มีคุณภาพและผลิตขึ้นด้วยความชำนาญ. หากมีข้อบกพร่องเกิดขึ้นในระหว่างระยะเวลาการรับประกัน Emaux จะทำการซ่อมแซมหรือเปลี่ยนชิ้นส่วนดังกล่าวและรับผิดชอบค่าใช้จ่ายเอง. ลูกค้าจะต้องปฏิบัติตามขั้นตอนการอ้างสิทธิ์การรับประกันข้างต้นจาก Emaux เพื่อให้ได้รับประโยชน์จากการรับประกันนี้.

อย่างไรก็ตามในการการรับประกัน Emaux จะไม่รับผิดชอบสำหรับค่าจัดส่งหรือขนส่งในการส่งคืนสินค้าให้กับ Emaux และการส่งมอบผลิตภัณฑ์ที่ได้รับการซ่อมแซม หรือ เปลี่ยนให้กับลูกค้า. Emaux จะไม่รับผิดชอบต่อการสูญเสียเวลา ความไม่สะดวก หรือ ค่าใช้จ่ายอื่น ๆ เช่น ค่าแรง ค่าโทรศัพท์ ค่าใช้จ่ายทางกฎหมายหรือค่าวัสดุที่เกิดขึ้นเนื่องจากการเปลี่ยน หรือ การกำจัดผลิตภัณฑ์และความเสียหายอื่น ๆ ที่เป็นผลหรือ บังเอิญต่อบุคคล หรือ สินทรัพย์.

Emaux จะไม่รับผิดชอบต่อการสูญเสียผลกำไรทางธุรกิจ อันเนื่องมาจากการหยุดการดำเนินงาน และ ผลิตภัณฑ์ที่ไม่เป็นไปตามข้อกำหนด. ไม่มี การชดใช้ค่าเสียหายหรือความเสียหายใด ๆ ในการอ้างสิทธิ์

**การรับประกัน หรือการรับรองจากบุคคลอื่น**

ไม่มีตัวแทนจำหน่ายหรือบุคคลใดมีอำนาจในการรับประกันในนาม แบรินด์ / กลุ่ม ของ Emaux ดังนั้น Emaux จะไม่รับผิดชอบต่อการรับประกัน หรือ การเป็นตัวแทนดังกล่าว

นโยบายการรับประกัน Emaux (2019/2020) ฉบับนี้ใช้แทนคำแถลง / เอกสารเผยแพร่การรับประกันฉบับก่อนหน้าทั้งหมด

บริษัท Emaux Water Technology จำกัด ขอสงวนสิทธิ์ในการใช้สิทธิ์ทั้งหมดในกรณีที่มีข้อพิพาท

# WARRANTY EMAUX

## INTRODUCTION

This warranty supersedes all previous publications. Emaux Water Technology Co., Ltd. ("Emaux") manufactures its products with the highest standard of workmanship, using the best materials available through state of the art process. Emaux proudly warrants its products as follows:

## WARRANTY FOR SPECIFIC PRODUCTS (FROM DATE OF INVOICE)

Product	Warranty Period
<b>FILTER</b>	
<b>MFV &amp; MFS &amp; T</b>	5 Years - filter tank, 1 year - all other parts
<b>P &amp; PS</b>	3 Years - filter tank, 1 year - all other parts
<b>V, S, SR, SD, LF &amp; HD</b>	5 Years Pro-Rata - filter tank, 1 year - all other parts
<b>TMG &amp; SMG</b>	5 Years Pro-Rata - filter tank, 1 year - all other parts
<b>COMMERCIAL FILTER</b>	
<b>NL, E, H &amp; K</b>	5 Years Pro-Rata - filter tank, 1 year - all other parts
<b>PUMP</b>	
<b>EPV, EPH, SPV &amp; SPH</b>	3 Years (Variable Speed Driver – 2 years, Seal & O-ring – 1 year)
<b>SB, SR, SS</b>	2 Years (Seal & O-ring – 1 year)
<b>SD, ST, AquaMini</b>	1 Year
<b>C-SE, Hydrau-Power</b>	3 Years (Seal & O-ring – 1 year)
<b>SWP</b>	5 Years Pro-Rata (Seal & O-ring – 1 year)
<b>Mechanical</b>	1 Year (Other parts 3 months)
<b>DISINFECTION</b>	
<b>Nano-Tech UV-C, MPUV &amp; FOS</b>	2 Years (Lamp & Sleeve – 1 year)
<b>Salt Chlorinator</b>	2 Years
<b>Ozo-Plus Ozone Generator</b>	2 Years
<b>OZG-4G &amp; OZG-8G</b>	
<b>CL, CLL</b>	1 Year
<b>CTRL</b>	2 Years (Sensor – 1 year)
<b>UNDERWATER LIGHT</b>	1 Year
<b>SURROUNDING EQUIP</b>	1 Year
<b>HEATING SYSTEM</b>	1 Year
<b>WHITE GOODS</b>	1 Year
<b>CLEANING EQUIPMENT</b>	1 Year
<b>OTHERS</b>	1 Year

\*NOTE : Pro-Rata = 3 years full , 4th 50% , 5th 30%

## CLAIM PROCESS

Summary of Emaux's Claim Process in 3 Steps:-

- Claim against the warranty: Customer contacts Emaux's salesperson and provides completed details of the claim which includes:
  - Information about the failed/damaged products e.g. the product part number(s) and serial number(s)
  - Description of the complaint/failure
  - Relevant pictures
- Once the complaint is received, it will be reviewed by Emaux's Quality Department in accordance to the "Emaux Warranty Policy" in the 2019 Emaux Product Catalogue.
- After the investigation is completed, Emaux will inform the distributor of the said products and follow up with the customer accordingly.

### **THIS WARRANTY SHALL NOT APPLY IN THE EVENT OF:-**

1. Damage caused by careless handling, improper repackaging, or shipping.
2. Damage due to misapplication, misuse, abuse or failure to operate and install the equipment as specified in the owner's manual.
3. Damage caused by a misuse, abuse or failure to operate and install the equipment out of the scope of a professional level demanded in similar equipment or installation type.
4. Damage due to unauthorized product modifications or failure to use original replacement parts of Emaux.
5. Damage caused by negligence or failure to properly maintain products as specified in the owner's manual.
6. Damage caused by failure to maintain water chemistry in conformity with the standards of the swimming pool industry for any length of time
7. Damage caused by water freezing inside the product.
8. Accidental damage, fire or other circumstances outside the control of Emaux
9. Any willful modification, alteration or repair in any way made to any part of the product by any person that is not authorized by Emaux.
10. Wear & tear parts.
11. Damage caused by misapplication of electricity, natural calamities, or physical force.

### **EMAUX'S LIABILITY FOR THE PRODUCTS**

Emaux warrants that its products are of sound material and workmanship. Should a defect become evident during the term of warranty, Emaux will, at its option, repair or replace such item or part at its own cost and expense. Customer will need to follow the above warranty claim process from Emaux in order to obtain the benefit of this warranty.

Emaux is not, however, responsible under this warranty for any cost of shipping or transportation for the return of the products to Emaux and the delivery of repaired or replacement product to customer. Emaux shall not be liable for any loss of time, inconvenience, incidental expenses such as labor cost, phone calls, legal cost or material cost incurred in connection with the replacement or removal of the product, and any other consequential or incidental damage on persons or assets.

Emaux will not be responsible for any business profit loss due to operation stop and the non-conformity product. No indemnity or damages can be claimed on any account what so ever.

### **WARRANTY OR REPRESENTATIONS BY OTHERS**

No dealer or other person has the authority to provide any warranty on behalf of Emaux or its brands / group. Accordingly, Emaux shall not responsible for any of such warranty or representation.

Emaux Warranty Policy (2019/2020): This document supersedes all previous version of our statements / publications.

Emaux Water Technology Co., Ltd. reserves the final right to exercise all warranties in case of disputes.

# การรับประกันสินค้า DOLPHIN

## WARRANTY - DOLPHIN



### ข้อความปฏิเสธการรับประกัน Maytronics Thailand

#### 1. การเตือนหากการซื้อทำในต่างประเทศ

- 1.1 สินค้าทั้งหมดของ Maytronics ที่แสดงอยู่บนเว็บไซต์ <https://maytronics-thailand.com> (สินค้า Maytronics) ได้รับการออกแบบ และดัดแปลงขึ้น โดยเฉพาะเพื่อให้สอดคล้องกับกฎหมายและมาตรฐานของประเทศไทย
- 1.2 เนื่องจากกฎหมายและมาตรฐานที่ใช้กับสินค้าและบริการมีนัยสำคัญค่อนข้างมากตามขอบเขตอำนาจศาลที่แตกต่างกัน, Maytronics ประเทศไทย มีความมั่นใจว่าการปรับเปลี่ยนที่จำเป็นทั้งหมดที่ทำกับสินค้าของ Maytronics ได้เป็นไปตามมาตรฐาน ผลิตภัณฑ์และความปลอดภัยของประเทศไทย
- 1.3 หากคุณมีการซื้อหรือนำเข้าสินค้าแบรนด์ Maytronics หรือที่คล้ายกันกับสินค้าใดๆของ Maytronics ที่แสดงบนเว็บไซต์ <https://maytronics-thailand.com> จากประเทศที่ไม่ใช่ประเทศไทย, รวมถึงทางอินเทอร์เน็ตจากเว็บไซต์อื่นที่ไม่ใช่เว็บไซต์ <https://maytronics-thailand.com> โปรดระวังว่าสินค้านั้นไม่ได้มาจาก Maytronics ประเทศไทย และอาจไม่สอดคล้องกับกฎหมาย และมาตรฐานของประเทศไทย เรื่องนี้อาจมีผลต่อความถูกต้องในการรับประกันของสินค้าใด ๆ ที่คุณมี
- 1.4 หากเป็นเช่นนั้น, Maytronics ประเทศไทยไม่ใช่ผู้ผลิตหรือผู้จัดจำหน่ายของสินค้าที่คุณได้ซื้อ และไม่มีภาระผูกพันที่จะต้องให้ การรับประกันใด ๆ ให้กับคุณโดยผู้จัดจำหน่ายหรือผู้ผลิตในต่างประเทศ หรือเพื่อการซ่อมหรือเปลี่ยนสินค้าของคุณฟรี
- 1.5 โปรดติดต่อเราหากคุณต้องการความช่วยเหลือจากเราเพื่อยืนยันว่าสินค้า Maytronics ที่คุณได้ซื้อจากเว็บไซต์อื่นที่ไม่ใช่ <https://maytronics-thailand.com> สอดคล้องกับกฎหมายและมาตรฐานของประเทศไทย

#### 2. ความรับผิดชอบ

- 2.1 ภายใต้ข้อ 2.2 และขอบเขตสูงสุดที่กฎหมายอนุญาต, เรา (Maytronics ประเทศไทย) เราไม่รับผิดชอบต่อความสูญเสีย, ความเสียหาย, ค่าใช้จ่าย หรือ ความรับผิดชอบใด ๆ (ไม่ว่าทางตรง, ทางอ้อม, ผลที่ตามมา, ตัวอย่าง, ความพิเศษ, การลงโทษอื่น ๆ) อย่างไรก็ตาม (รวมถึงความประมาทเลินเล่อของ Maytronics ประเทศไทย), การรับความเดือดร้อนจากบุคคลใด ๆ (รวมถึงตัวคุณด้วย) ในการติดต่อ กับการซื้อ, การผลิตหรือการนำเข้าของสินค้าแบรนด์ Maytronics จากอำนาจศาลนอกประเทศไทย, รวมถึงที่ทำการซื้อผ่านเว็บไซต์อื่น ที่ไม่ใช่ <https://maytronics-thailand.com> (ไม่ว่าจะเป็นการจัดหา, การติดตั้ง, การทำงาน, ความขัดข้อง, การใช้งาน หรือการใช้งาน ที่ผลิตอื่น ๆ)
- 2.2 หากการแข่งขัน และพระราชบัญญัติผู้บริโภค หรือด้วยกฎหมายอื่น ๆ ให้มีการรับประกันที่เกี่ยวข้องกับสินค้าและบริการที่จัดทำโดย Maytronics ประเทศไทย ที่สัมพันธ์กับการจัดหาสินค้าของ Maytronics และ ความรับผิดชอบของ Maytronics ประเทศไทยในความผิด ในการปฏิบัติตามการรับประกันไม่สามารถ ยกเว้นได้แต่อาจถูกจำกัดได้, หรือเป็นความรับผิดชอบอื่น ๆ ที่ไม่สามารถยกเว้นตามข้อ 2.1 ข้างต้น, ข้อ 2.1 ไม่สามารถใช้กับความรับผิดชอบ และแทนที่ ความรับผิดชอบของ Maytronics ประเทศไทยสำหรับความผิดพลาด (หรือความรับผิดชอบอื่น ๆ ที่ไม่สามารถยกเว้นได้ตามที่เกี่ยวข้องกัน) ที่จำกัด (ในการเลือกของ Maytronics ประเทศไทย), ในกรณี ของการจัดหาสินค้า, Matronics ประเทศไทยทำการเปลี่ยนสินค้า หรือการจัดหาสินค้าที่เทียบเท่า หรือ ซ่อมสินค้า หรือการจ่ายค่าใช้จ่าย อื่น ๆ สำหรับการแก้ไขความเสียหายทั้งสามนั้น, หรือในกรณีการจัดหาบริการ Maytronics ประเทศไทย จะทำการจัดหา บริการให้อีกครั้ง หรือจ่ายค่าใช้จ่ายในการจัดหาบริการให้

### DISCLAIMER MAYTRONICS THAILAND PRODUCTS:

#### 1. Warning if purchase made overseas

- 1.1 All Maytronics products displayed on the <https://maytronics-thailand.com> website (Maytronics Products) are specifically designed and modified to comply with Thailand laws and standards.
- 1.2 Given that the laws and standards that apply to goods and services can vary quite significantly in different jurisdictions, Maytronics Thailand has ensured that all necessary modifications have been made to the Maytronics Products such that they meet Thailand's strict product and safety standards.
- 1.3 If you have purchased or imported a product with a 'Maytronics' brand or similar to any of the Maytronics products displayed on <https://maytronics-thailand.com> from a country outside Thailand, including via the internet from a website other than <https://maytronics-thailand.com>, please be aware that that product was not supplied by Maytronics Thailand and may not comply with Thailand laws and standards. This may also affect the validity of any product liability insurances you may have in place.
- 1.4 If that is the case, Maytronics Thailand is not the manufacturer or supplier of the product you have purchased and has no obligation to honour any warranty given to you by the overseas supplier or manufacturer or to repair or replace your product for free.
- 1.5 Please contact us if you would like our assistance to confirm whether a Maytronics Product you have purchased from a website other than <https://maytronics-thailand.com> complies with Thailand laws and standards.

#### 2. Liability

- 2.1 Subject to clause 2.2 and to the maximum extent permitted by law, we (Maytronics Thailand) are not liable for any loss, damage, cost, expense or liability (whether direct, indirect, consequential, exemplary, special, punitive or otherwise) however caused (including by the negligence of Maytronics Thailand), suffered by any person (including you) in connection with the purchase, manufacture or importation of Maytronics-branded products from jurisdictions outside Thailand, including where the purchase is made via websites other than <https://maytronics-thailand.com> (whether in relation to supply, installation, operation, failure, use or misuse or otherwise).
- 2.2 If the Competition and Consumer Act 2010 (Cth) or any other legislation provides that there is a guarantee in relation to any good or service supplied by Maytronics Thailand in connection with the supply of Maytronics Products and Maytronics Thailand's liability for failing to comply with that guarantee cannot be excluded but may be limited, or there is other liability that cannot be excluded pursuant to clause 2.1 above, then clause 2.1 does not apply to that liability and instead Maytronics Thailand's liability for such failure (or other non-excludable liability, as relevant) is limited to (at Maytronics Thailand's election), in the case of a supply of goods, Maytronics Thailand replacing the goods or supplying equivalent goods or repairing the goods or paying the cost of any of those three remedies, or in the case of a supply of services, Maytronics Thailand supplying the services again or paying the cost of having the services supplied again.



## การรับประกันสินค้า S SERIES WARRANTY - S SERIES

### หนังสือรับประกันระยะเวลา 24 เดือน จาก MAYTRONICS รุ่น S Series

เมื่อตัดสินใจใช้เครื่องทำความสะอาดสระว่ายน้ำ หมายความว่าท่านได้ยอมรับข้อกำหนดในการให้บริการของการรับประกันนี้ เครื่องทำความสะอาดสระว่ายน้ำของ MAYTRONICS ได้รับการรับรองว่าปราศจากข้อบกพร่องของวัสดุและมีผลการผลิตภายใต้การใช้งานและการให้บริการตามปกติ โดยขึ้นอยู่กับคุณสมบัติ, เงื่อนไข และ

หากคุณเป็นเจ้าของเครื่องทำความสะอาดสระว่ายน้ำ MAYTRONICS กรุณาศึกษาเงื่อนไขของ MAYTRONICS จะตรวจสอบเครื่องและ MAYTRONICS หักเงินจากการรับประกันถูกต้อง ตัวแทนจะทำการซ่อมหรือเปลี่ยนอุปกรณ์หรือชิ้นส่วนที่ชำรุดและส่งคืนให้กับคุณโดยที่ MAYTRONICS เป็นผู้รับผิดชอบค่าใช้จ่าย.

ผลประโยชน์ภายใต้การรับประกันนี้ นอกเหนือจากสิทธิและการเยียวยาอื่น ๆ ภายใต้กฎหมายของคุณ ไม่สามารถแยกตามกฎหมายหรือตามสัญญาของคุณกับตัวแทนจำหน่ายได้ สินค้าของเราจะมาพร้อมกับการรับประกันที่สามารถได้รับการยกเว้นตามกฎหมายผู้บริโภคออสเตรเลีย คุณมีสิทธิ์เปลี่ยนหรือขอคืนเงินสำหรับความล้มเหลวและการชดเชยค่าเสียหายที่คาดการณ์ได้ คุณมีสิทธิ์ที่จะได้รับการซ่อมแซม หรือเปลี่ยนสินค้าที่ดี และคุณภาพที่ยอมรับไม่ได้ ซึ่งไม่ได้เป็นความล้มเหลวที่สำคัญ.

ในขอบเขตสูงสุดที่กฎหมายอนุญาต : ข้อจำกัดในการรับประกันของ MAYTRONICS จะจำกัดเฉพาะการซ่อมแซมหรือเปลี่ยนผลิตภัณฑ์หรือชิ้นส่วนที่มีข้อบกพร่องโดยการตัดสินใจของ MAYTRONICS.

MAYTRONICS จะไม่รับผิดชอบต่อผู้ซื้อหรือบุคคลอื่นในความสูญเสีย ความเสียหาย การบาดเจ็บ การดำเนินการการเรียกร้อง ค่าใช้จ่าย รวมทั้งค่าใช้จ่าย จากการบาดเจ็บหรือความเสียหายต่อบุคคลหรือทรัพย์สิน และความเสียหายต่อปูนหรือไวนิลในสระ ที่เกิดขึ้นจากการใช้ผลิตภัณฑ์ หรือความผิดพลาดของการทำงานของผลิตภัณฑ์ทางใดก็ตาม และ MAYTRONICS ไม่รวมการรับประกันหรือการรับรองทั้งหมดที่แสดงหรือจำกัดโดย MAYTRONICS นอกเหนือจากที่ระบุไว้โดยเฉพาะในการรับประกันนี้ซึ่งไม่สามารถแยกออกตามกฎหมายได้.

ไม่มีบุคคล บริษัท หรือสถานประกอบการใดที่ได้รับอนุญาตให้ทำหน้าที่เป็นตัวแทน หรือมีภาระหน้าที่ใด ๆ ในนามของ MAYTRONICS การรับประกันนี้เป็นข้อตกลงฉบับสมบูรณ์และเห็นชอบระหว่าง MAYTRONICS กับผู้ซื้อ.

### 24 MONTHS LIMITED WARRANTY FROM MAYTRONICS S SERIES

By using the pool cleaner, you accept the terms and conditions of this warranty. This MAYTRONICS pool cleaner is warranted to be free from

or under your contract with your supplier.

Our goods come with guarantees that cannot be excluded under the Australian Consumer Law. You are entitled to a replacement or refund for a major failure and compensation for any other reasonably foreseeable loss or damage. You are also entitled to have the good repaired or replaced if the goods fail to be of acceptable quality and the failure does not amount to a major failure.

To the maximum extent permitted by law: The warranty obligations of MAYTRONICS shall be limited to repair or replacement of the product or of any defective component, at the option of MAYTRONICS;

MAYTRONICS shall not be liable or responsible under any circumstances or in any amount to the purchaser or any other person for any loss, damage, injuries, action, claims, costs or expenses, including injury or damage to person or property, and damages to pool plaster or vinyl liner in any pool, arising out of the use or reliance on or failure of the product in any way whatsoever; and MAYTRONICS excludes all the warranties or representations, express or limited, made by MAYTRONICS other than those specifically set forth in this warranty unable to be excluded by law.

No person, firm or corporation ins authorized to make any representations or incur any obligations in the name of or on behalf of MAYTRONICS. This warranty contains the full and complete agreements between MAYTRONICS and the Purchaser.



# การรับประกันสินค้า M SERIES



## WARRANTY - M SERIES

### หนังสือรับประกันระยะเวลา 36 เดือน จาก MAYTRONICS รุ่น M Series

เมื่อตัดสินใจใช้เครื่องทำความสะอาดสระว่ายน้ำ หมายความว่า คุณได้ยอมรับข้อกำหนดในการให้บริการของการรับประกันนี้ เครื่องทำความสะอาดสระว่ายน้ำของ MAYTRONICS ได้รับการรับรองว่าปราศจากข้อบกพร่องของวัสดุและฝีมือการผลิตภายใต้การใช้งานและการให้บริการตามปกติ โดยขึ้นอยู่กับคุณสมบัติ, เงื่อนไข

ผลประโยชน์ภายใต้การรับประกันนี้ นอกเหนือจากสิทธิและการเยียวยาอื่น ๆ ภายใต้กฎหมายของคุณ ไม่สามารถแยกตามกฎหมายหรือตามสัญญาของคุณกับตัวแทนจำหน่ายได้ สินค้าของเราพร้อมกับการรับประกันที่ไม่สามารถได้รับการยกเว้นตามกฎหมายผู้บริโภคออสเตรเลีย คุณมีสิทธิ์เปลี่ยน หรือขอคืนเงินสำหรับความล้มเหลว และการชดเชยค่าเสียหายที่คาดการณ์ได้ คุณมีสิทธิ์ที่จะได้รับการซ่อมแซม หรือเปลี่ยนสินค้าที่ดี และคุณภาพที่ยอมรับไม่ได้ ซึ่งไม่ได้เป็นความล้มเหลวที่สำคัญ.

ในขอบเขตสูงสุดที่กฎหมายอนุญาต :

ข้อจำกัดในการรับประกันของ MAYTRONICS จะจำกัดเฉพาะการซ่อมแซมหรือเปลี่ยนผลิตภัณฑ์หรือชิ้นส่วนที่มีข้อบกพร่อง โดยการตัดสินใจของ MAYTRONICS; MAYTRONICS จะไม่รับผิดชอบต่อผู้ซื้อหรือบุคคลอื่นในความสูญเสีย ความเสียหาย การบาดเจ็บ การดำเนินการการเรียกร้อง ค่าใช้จ่าย รวมทั้งค่าใช้จ่าย จากการบาดเจ็บ หรือความเสียหายต่อบุคคลหรือทรัพย์สิน และความเสียหายต่อปูนหรือไวโนลในสระ ที่เกิดขึ้นจากการใช้ผลิตภัณฑ์ หรือความผิดพลาดของการทำงานของผลิตภัณฑ์ ทางใดก็ตาม และ MAYTRONICS ไม่รวมการรับประกันหรือการรับรองทั้งหมดที่แสดงหรือจำกัดโดย MAYTRONICS นอกเหนือจากที่ระบุไว้โดยเฉพาะในการรับประกันนี้ ซึ่งไม่สามารถแยกออกตามกฎหมายได้.

ไม่มีบุคคล บริษัท หรือสถานประกอบการใดที่ได้รับอนุญาตให้ทำหน้าที่เป็นตัวแทนหรือมีภาวะหน้าที่ใด ๆ ในนามของ MAYTRONICS การรับประกันนี้เป็นข้อตกลงฉบับสมบูรณ์และเห็นชอบระหว่าง MAYTRONICS กับผู้ซื้อ.

### 36 MONTHS LIMITED WARRANTY FROM MAYTRONICS M SERIES

By using the pool cleaner, you accept the terms and conditions of this warranty. This MAYTRONICS pool cleaner is warranted to be free from defects in materials and workmanship under normal use and service, subject to qualifications, conditions and limitations as described below.

Our goods come with guarantees that cannot be excluded under the Australian Consumer Law. You are entitled to a replacement or refund for a major failure and compensation for any other reasonably foreseeable loss or damage. You are also entitled to have the good repaired or replaced if the goods fail to be of acceptable quality and the failure does not amount to a major failure.

To the maximum extent permitted by law: The warranty obligations of MAYTRONICS shall be limited to repair or replacement of the product or of any defective component, at the option of MAYTRONICS;

MAYTRONICS shall not be liable or responsible under any circumstances or in any amount to the purchaser or any other person for any loss, damage, injuries, action, claims, costs or expenses, including injury or damage to person or property, and damages to pool plaster or vinyl liner in any pool, arising out of the use or reliance on or failure of the product in any way whatsoever; and MAYTRONICS excludes all the warranties or representations, express or limited, made by MAYTRONICS other than those specifically set forth in this warranty unable to be excluded by law.

No person, firm or corporation is authorized to make any representations or incur any obligations in the name of or on behalf of MAYTRONICS. This warranty contains the full and complete agreements between MAYTRONICS and the Purchaser.

# การรับประกันสินค้า WAVE SERIES

## WARRANTY - WAVE SERIES

### หนังสือรับประกัน หุ่นยนต์ทำความสะอาดสระว่ายน้ำ เพื่อการพาณิชย์รุ่น Wave Series

หุ่นยนต์ทำความสะอาดสระว่ายน้ำของ MAYTRONIC รุ่น WAVE ผ่านการทดสอบ และตรวจเช็คการผลิตตามข้อกำหนดด้านวิศวกรรมที่ระบุไว้อย่างละเอียด ได้รับการรับรองว่า ปราศจากข้อบกพร่องของวัสดุและฝีมือการผลิตภายใต้การใช้งานและการให้บริการตามปกติโดยขึ้นอยู่กับคุณสมบัติ, เงื่อนไข และข้อจำกัดตามที่อธิบายไว้ด้านล่าง. การรับประกันนี้ครอบคลุมผู้บริโภคน / ผู้ซื้อมาเป็นระยะเวลา 24 เดือนหรือ 3,000 ชั่วโมงทำงาน นับจากวันที่ซื้อครั้งแรก การรับประกันมีผลบังคับใช้ภายในประเทศที่ซื้อผลิตภัณฑ์หุ่นยนต์ทำความสะอาดสระว่ายน้ำ หากผลิตภัณฑ์ถูกนำออกไปต่างประเทศการรับประกันจะสิ้นสุดลง.

ควรมารักษาเชิงป้องกัน (PM (Preventive Maintenance) หุ่นยนต์ทำความสะอาดสระว่ายน้ำรุ่น WAVE อย่างต่อเนื่องเพื่อรักษาให้อยู่ในสภาพการทำงานที่ดีและยาวนาน MAYTRONICS มีอุปกรณ์ที่จำเป็นสำหรับการบำรุงรักษาเชิงป้องกัน โดยให้บริการและใช้งานผ่านตัวแทนจำหน่าย การบำรุงรักษาเชิงป้องกันควรทำทุก 1,500 ชั่วโมงทำงานหรือ 1 ปี (หรือก่อนหน้าของทั้งสองข้อ) เมื่อได้เวลาการบำรุงรักษาเชิงป้องกัน ข้อความแจ้งเตือนบนหน้าจอ MMI ถือเป็นพันธะว่าต้องดำเนินการบำรุงรักษาเชิงป้องกันทันที กรุณาติดต่อตัวแทนจำหน่ายของคุณ การไม่ปฏิบัติตามการบำรุงรักษาเชิงป้องกันจะทำให้การรับประกันเป็นโมฆะ.

หุ่นยนต์ทำความสะอาดสระว่ายน้ำ MAYTRONICS รุ่น WAVE ถูกออกแบบมาให้ทำงานในสระน้ำเกลือที่ 5000 พีพีเอ็ม การใช้เครื่องในสระน้ำทะเลจะทำให้การรับประกันเป็นโมฆะ.

การรับประกันนี้ครอบคลุมการใช้งานตามสภาวะปกติสมเหตุสมผลของเครื่อง และ ข้อบกพร่องจากการผลิตเท่านั้น ความเสียหาย การชำรุดบกพร่องหรือความผิดพลาดจากการใช้งานอื่น ๆ หรือการใช้งานที่ไม่เป็นไปตามคำแนะนำในคู่มือการใช้งานรวมทั้งความผิดพลาดของผู้ซื้อไม่บำรุงรักษาตามความจำเป็นและเหมาะสมจะทำให้การรับประกันเป็นโมฆะ ความเสียหาย ข้อบกพร่อง การทำงานผิดพลาดหรือความผิดพลาดอื่น ๆ ที่เกี่ยวข้องหรือเกิดจากการซ่อมแซมของของศูนย์ หรือบุคคลอื่นที่ไม่ใช่ตัวแทนที่ได้รับอนุญาตของ MAYTRONICS จะไม่ได้รับการคุ้มครอง การใช้ส่วนประกอบไฟฟ้าใด ๆ ที่นอกเหนือจากที่ MAYTRONICS ผลิตขึ้นจะทำให้การรับประกันเป็นโมฆะ MAYTRONICS ขอสงวนสิทธิ์ ในการเรียกร้อง และการอ้างสิทธิ์ใด ๆ ของผู้ซื้อในการเรียกร้องค่าเสียหายใด ๆ ที่เกิดกับหุ่นหรือไวโอลในสระของผู้ซื้อ จาก MAYTRONICS ด้วยเหตุผลจากการใช้งาน และ / หรือการทำงานของหุ่นยนต์ทำความสะอาดสระว่ายน้ำของ MAYTRONICS รุ่น WAVE.

ขอบเขตการรับประกันของศูนย์บริการที่ได้รับอนุญาตของ MAYTRONICS จำกัดเฉพาะการซ่อมแซมหรือเปลี่ยนผลิตภัณฑ์หรือชิ้นส่วนที่มีข้อบกพร่อง ตามความเห็นชอบของ MAYTRONICS การซ่อมแซมหรือเปลี่ยนชิ้นส่วนดังกล่าวอาจรวมถึงส่วนประกอบและ / หรือเครื่องที่ได้รับการปรับแต่งใหม่ตามความเห็นชอบของ MAYTRONICS.

MAYTRONICS จะไม่รับผิดชอบหรือมีความรับผิดชอบต่อมูลค่าใด ๆ ภายใตีสถานการณ์หรือความเสียหายที่เป็นผลสืบเนื่องหรือโดยบังเอิญจากการบาดเจ็บหรือความเสียหายต่อบุคคลที่ใช้ผลิตภัณฑ์หรือทรัพย์สินหรือลักษณะการสูญเสียกำไรหรือค่าใช้จ่ายอื่น ๆ.

ไม่มี การรับประกันหรือการรับรองอื่นใดไม่ว่าจะโดยชัดแจ้งหรือโดยนัยจากความสามารถในการทำอะไร ความเหมาะสมต่อวัตถุประสงค์เฉพาะหรืออื่น ๆ ที่ออกโดย MAYTRONICS นอกจากจะกำหนดไว้เป็นอย่างอื่นในการรับประกันนี้ ไม่อนุญาตให้มีการมอบอำนาจ หรือมีการผูกพันใด ๆ กับบุคคล, บริษัท หรือสถานประกอบการในนามของ MAYTRONICS ยกเว้นกรณีที่ระบุไว้ในที่นี้ ข้อควรปฏิบัติตามที่ระบุไว้ในการรับประกันนี้ถือเป็นสิ่งที่ต้องใช้เพื่อเป็นแนวทางในการซื้อของผู้ซื้อ การรับประกันนี้รวมถึงข้อตกลงฉบับสมบูรณ์ที่เป็นที่ยอมรับของ MAYTRONICS และผู้ซื้อ. การรับประกันนี้กำหนดข้อบังคับเฉพาะของ MAYTRONICS เกี่ยวกับผลิตภัณฑ์นี้ไม่มีคำอธิบายและการรับประกันใด ๆ เพิ่มเติมนอกเหนือจากนี้.

ในการขอรับบริการการรับประกันโปรดติดต่อตัวแทนจำหน่าย MAYTRONICS ที่ได้รับอนุญาตใกล้บ้านคุณ โปรดแนบสำเนาใบแจ้งรายการสินค้าที่ซื้อ รวมทั้งวันที่ซื้อ เลขที่ประจำผลิตภัณฑ์และรายละเอียดของปัญหา.

### WAVE SERIES COMMERCIAL ROBOT POOL CLEANER WARRANTY CERTIFICATE

This MAYTRONICS Wave robot pool cleaner has been manufactured, tested and inspected in accordance with carefully specified engineering requirements. It is warranted to be free from defects in materials and workmanship under normal use and service to qualifications, conditions and limitations as described below.

This warranty extends to the first consumer/purchaser for a period of 24 months or 3000 working hours – the earlier of the two from the date of original purchase. The warranty is applicable to the country in which the pool cleaner was purchased, If the product is taken abroad the warranty will be invalidated.

Preventive Maintenance (PM) should be performed on the Wave robot pool cleaner, in order to keep it in good and long lasting working condition. MAYTRONICS provides the parts required – as a dedicated PM kit. The work and the service will be provided through the dealer. PM service should be performed every 1,500 working hours or 1 year (the earlier of the two). A warning message to perform PM will appear on the MMI screen, when applicable. It is obligatory that PM service will be performed. Please contact your dealer. Failure to perform the PM service will void the warranty.

MAYTRONICS Wave robot pool cleaner is designed to work in salty water up to 5000 P.P.M. the use of the unit in sea water pools, will void the warranty. This warranty covers only normal and reasonable use of the unit. The warranty is for manufacturing defects only. Damage, defects malfunctions or other failures or any use which does not comply with the instruction in the operator's manual including the failure of the purchaser to provide reasonable and necessary maintenance, shall invalidate this warranty. Damage, defects malfunctions or other failures caused by or related to repair performed by any service station or person other than an authorized service representative of MAYTRONICS shall not be covered.

The use of any electrical components other than originally manufactured by MAYTRONICS will invalidate the warranty MAYTRONICS hereby disclaims any and all claims, and purchaser releases MAYTRONICS from any and all claims for damages to any pool plaster or vinyl liner in purchaser's pool by reason of the use and/or operation of the MAYTRONICS Wave robot pool cleaner.

The warranty obligations of MAYTRONICS authorized service station shall be limited to repair or replacement of the product or of any defective component, at the option of MAYTRONICS. Such repair or replacement may include the use of refurbished components and/or units at the option of MAYTRONICS. MAYTRONICS shall not be liable or responsible under any circumstances or in any amount for any consequential or incidental damages, or for any injury or damages to person or property using or used in connection with the product, or for loss of profit or other costs or expense of any kind of character.

**THERE ARE NO OTHER WARRANTIES OR REPRESENTATIONS, EITHER EXPRESS OR IMPLIED, WHETHER OF MERCHANTABILITY, FITNESS FOR A PARTICULAR PURPOSE, OR OTHER, MADE BY MAYTRONICS OTHER THAN THOSE SPECIFICALLY SET FORTH IN THIS WARRANTY. NO PERSON, FIRM, OR CORPORATIONS IS AUTHORIZED TO MAKE ANY REPRESENTATIONS OR INCUR ANY OBLIGATIONS IN THE NAME OF OR ON BEHALF OF MAYTRONICS, EXCEPT AS STATED HEREIN. THE REMEDIES SET FORTH IN THIS WARRANTY ARE EXPRESSLY UNDERSTOOD TO BE THE EXCLUSIVE REMEDIES AVAILABLE TO THE PURCHASER, AND THIS WARRANTY CONTAINS THE FULL AND COMPLETE AGREEMENT BETWEEN MAYTRONICS AND THE PURCHASER. THIS WARRANTY SETS FORTH THE ONLY OBLIGATIONS OF MAYTRONICS WITH REGARDS TO THIS PRODUCT, AND THERE ARE NO WARRANTIES WITH EXTEND BEYOND THE DESCRIPTION ON THE FACE HEREOF.**

To obtain warranty service, contact your nearest authorized MAYTRONICS dealer. Attach to the unit a copy of the invoice including date of purchase, serial number and description of the problem.

# การรับประกันสินค้า

## LEDGE LOUNGER



ที่ Ledge Lounger เรามีความภาคภูมิใจที่ผลิตภัณฑ์ของเราที่มีความทนทานและมีอายุการใช้งานที่ยาวนาน เรารับประกันว่าผลิตภัณฑ์ของเราจะมีคุณภาพและมีมือที่ยอดเยี่ยมปราศจากข้อบกพร่องและตำหนิ เรามีความมุ่งมั่นที่จะรักษาความสัมพันธ์ที่ยั่งยืน ดังนั้นในกรณีที่ผลิตภัณฑ์ของคุณมีข้อบกพร่อง โปรดปฏิบัติตามขั้นตอนในส่วน "การยื่นคำร้องการรับประกัน" ที่อยู่ด้านล่าง

เงื่อนไขการรับประกันสินค้าเรานั้นแตกต่างกันขึ้นอยู่กับผลิตภัณฑ์ วัสดุ และกลุ่มผลิตภัณฑ์ ผลิตภัณฑ์ทั้งหมดนั้นได้รับการรับรองจากการรับประกันข้อบกพร่องโดยผู้ผลิตแบบมีข้อจำกัด

### ผลิตภัณฑ์เอกลักษณ์และกลุ่มผลิตภัณฑ์ที่ใกล้เคียงกัน (SIGNATURE & AFFINITY COLLECTION PRODUCTS)

ผลิตภัณฑ์จะต้องไม่มีตำหนิด้านวัสดุ และต้องไม่แตก ร้าว บิ่น ลอก หรือเปื่อยเป็นเวลาสอง (2) ปีนับจากวันที่ซื้อเพื่อใช้ในเชิงพาณิชย์และใช้ในครัวเรือน

### ผลิตภัณฑ์ของผลิตภัณฑ์แบรนด์เมนสเตย์, เลกาซี, ชิฟต์เดย์เบด และกลุ่มผลิตภัณฑ์ที่เกี่ยวข้องกับเกม (MAINSTAY, LEGACY, SHIFT DAYBED, AND GAMES COLLECTION PRODUCTS)

ผลิตภัณฑ์จะต้องไม่มีตำหนิด้านวัสดุ และต้องไม่แตก ร้าว บิ่น ลอก หรือเน่าเปื่อยเป็นเวลาสิบ (10) ปีสำหรับใช้ในครัวเรือน และสอง (2) ปีสำหรับใช้ในเชิงพาณิชย์ นับจากวันที่ซื้อ

### ส่วนอุปกรณ์ของผลิตภัณฑ์แบรนด์เมนสเตย์, เลกาซี, ชิฟต์เดย์เบด และกลุ่มผลิตภัณฑ์ที่เกี่ยวข้องกับเกม: (MAINSTAY, LEGACY, SHIFT DAYBED, AND GAMES COLLECTION PRODUCTS HARDWARE)

การรับประกันให้ดำเนินการตามที่กำหนดเป็นเวลาห้า (5) ปีสำหรับการใช้ในครัวเรือนและหนึ่งปี (1) ปีสำหรับใช้ในเชิงพาณิชย์นับจากวันที่ซื้อ

### ผลิตภัณฑ์ร่วม เบาะ และหมอน:

การรับประกันส่วนที่เป็นผ้าที่ต่างกันแตกต่างกันไปตามประเภทของผ้า และมีการรับประกันแบบจำกัดตามสัดส่วนที่ส่งมาจากโรงงานทอผ้า การรับประกันนี้ครอบคลุมถึงผ้าที่ไม่สามารถซ่อมบำรุงได้เนื่องจากการเสียดสีหรือสูญเสียความแข็งแรงจากสภาพการใช้งานปกติ รวมถึงแสงแดด ไรคราน้ำค้าง การเปื้อน และสารเคมีในบรรยากาศ การรับประกันไม่ครอบคลุมถึงผ้าหรือตะเข็บที่ฉีกขาด หรือเป็นขุย

- ผ้าอะคริลิกย้อมด้วยสีย้อมละลายชนิดที่ใช้ได้ในน้ำทะเล (marine grade) รับประกันความคงทนต่อแสงเป็นระยะเวลาสิบ (10) ปี
- ผ้าอะคริลิกย้อมด้วยสีย้อมละลายเกรดสำหรับเฟอร์นิเจอร์รับประกันเป็นระยะเวลาห้า (5) ปี
- ผ้าอะคริลิกย้อมด้วยสีย้อมละลายเกรดสังเคราะห์รับประกันเป็นระยะเวลาห้า (5) ปี
- Ledge Lounger ไม่รับประกันวัสดุที่ลูกค้านำมาเอง

### เสาร่วมและส่วนอุปกรณ์:

ตัวร่วมรับประกันห้า (5) ปีสำหรับการใช้ในครัวเรือนและเชิงพาณิชย์ นับจากวันที่ซื้อ โดยต้องไม่มีตำหนิด้านวัสดุและมีมือการผลิตทั้งหมดจะต้องยึดในฐานที่ถ่วงน้ำหนัก อย่างเหมาะสมเพื่อใช้ในการรับประกัน

การรับประกันไม่ครอบคลุมถึงเสาร่วม

ลูกค้าต้องหุ้มเมื่อลมพัดแรงในระดับที่ไม่ปลอดภัย

### โครงสร้างคานานำ:

โครงสร้างคานานำรับประกันสองปี (2) สำหรับการใช้ในครัวเรือนและเชิงพาณิชย์ นับจากวันที่ซื้อ โดยต้องไม่มีตำหนิในมือการผลิต คานานำทั้งหมดจะต้องได้รับการรักษาความปลอดภัยตามคำแนะนำที่ให้ไว้เพื่อใช้ในการรับประกัน

ลูกค้าต้องถอดผ้าออกจากคานานำเมื่อลมพัดแรงในระดับที่ไม่ปลอดภัย

รายการต่อไปนี้ไม่รวมอยู่ในการรับประกันแบบจำกัดสำหรับผลิตภัณฑ์ Ledge Lounger ทาง Ledge Lounger จะไม่รับผิดชอบต่อความล้มเหลว ข้อบกพร่อง หรือความเสียหายใด ๆ อันเป็นผลจากหรือเกี่ยวข้องกับสิ่งต่อไปนี้:

- การประกอบ ถอดประกอบ หรือการจัดการผลิตภัณฑ์อย่างไม่ถูกต้องหลังจากออกจากโรงงานของเรา รวมถึงแรงงานหรือการติดตั้งโดย Ledge Lounger ตัวแทนจำหน่าย หรือผู้ประกอบ
- การดัดแปลงใด ๆ ที่เกิดขึ้นกับผลิตภัณฑ์หลังการผลิต รวมถึงการดัดแปลงโครงสร้างหรือการใช้สารเคลือบใด ๆ บนผลิตภัณฑ์ที่ไม่ได้รับการอนุมัติจาก Ledge Lounger (รวมถึงสี สารเคมี น้ำยาเคลือบเงา ฯลฯ)
- การนำผลิตภัณฑ์ Ledge Lounger ไปสัมผัสกับความชื้นจากแหล่งภายนอก (รวมถึงเตาไฟ และแสงสะท้อนจากหน้าต่างและประตู)
- การสึกหรอและการฉีกขาดตามปกติ การใช้ผิดวัตถุประสงค์ หรือการละเลย การจัดการที่ไม่ถูกต้อง หรือการใช้งานที่ผิดปกติอื่น ๆ รวมถึงการใช้ผลิตภัณฑ์หรืออุปกรณ์เสริมที่เข้ากันไม่ได้ร่วมกันซึ่งไม่ได้ผลิตโดย Ledge Lounger
- ขาดการบำรุงรักษาตามปกติ / ที่แนะนำ (โปรดดูข้อมูลการทำความสะอาด / การบำรุงรักษา สำหรับรายละเอียดเกี่ยวกับวิธีการบำรุงรักษาผลิตภัณฑ์ Ledge Lounger)



- การขีดจาง - ผลิตภัณฑ์ Ledge Lounger ผลิตขึ้นเพื่อให้ทนต่อรังสี UV เพื่อลดการขีดจาง แต่เมื่อโดนแสงแดด สีจะจางลงในระดับหนึ่ง (เพื่อป้องกันการขีดจาง: ลดการโดนแสงแดดโดยตรงโดยการจัดเก็บหรือคลุมผลิตภัณฑ์)
- ความคลาดเคลื่อนของสี รูปแบบ หรือการเปลี่ยนแปลงของผลิตภัณฑ์ที่ซื้อในภายหลังหรือชิ้นส่วนอะไหล่ เมื่อเทียบกับของแท้
- สนิมหรือการกัดกร่อนของเหล็กกล้าไร้สนิมหรือฮาร์ดแวร์เหล็กเคลือบสังกะสี รวมถึงการผุกร่อนเนื่องจากการสัมผัสกับน้ำเค็ม
- สำหรับการใช้น้ำ ความสมดุลของสารเคมีในน้ำที่ใช้กับผลิตภัณฑ์ Ledge Lounger ไม่เหมาะสม
- ความเสียหายที่เกิดจากเหตุสุดวิสัย มลพิษทางอากาศหรือสภาพแวดล้อมอื่น ๆ สภาพอากาศที่กัดกร่อน การกระทำโดยเจตนา การใช้อย่างไม่สมเหตุสมผล การทำลายทรัพย์สิน หรือการก่อความไม่สงบ

การรับประกันใช้ไม่ได้กับ:

- ค่าขนส่ง ค่าแรง หรือค่าประกอบ
- ความเสียหายที่เกิดโดยบังเอิญหรือเป็นผลสืบเนื่องที่ เกิดจากการใช้ผลิตภัณฑ์
- กลุ่มหรือบุคคลอื่นใดที่ไม่ใช่เจ้าของเดิม

### การยื่นคำร้องการรับประกัน:

โปรดเตรียมหลักฐานการซื้อพร้อมเมื่อยื่นคำร้องการรับประกัน

ในการยื่นคำร้องการรับประกัน:

1. ติดต่อฝ่ายบริการลูกค้าของเราที่ 1-888-749-5336 หรือส่งอีเมลมาที่ [info@ledgeloungers.com](mailto:info@ledgeloungers.com) โปรดระบุชื่อ หมายเลขใบแจ้งหนี้ ข้อมูลติดต่อ รูปภาพ

# WARRANTY

## LEDGE LOUNGER



At Ledge Lounger, we take pride in the durability and longevity of our products. We guarantee that our products will be of exceptional quality and craftsmanship, and free from defects and flaws. We are committed to lasting relationships, so in the event that your product shows defects, please follow the steps in the "Submitting A Warranty Claim" section below.

Our warranty terms vary by product, material, and collection. All products are backed by a limited manufacturer's defect warranty.

### **SIGNATURE & AFFINITY COLLECTION PRODUCTS:**

Products shall be free from material defects, and shall not splinter, crack, chip, peel, or rot for two (2) years from the date of purchase for both commercial and residential use.

### **MAINSTAY, LEGACY, SHIFT DAYBED, AND GAMES COLLECTION PRODUCTS:**

Products shall be free from material defects, and shall not splinter, crack, chip, peel, or rot for ten (10) years for residential use and two (2) years for commercial use from the date of purchase.

### **MAINSTAY, LEGACY, SHIFT DAYBED, AND GAMES COLLECTION PRODUCT HARDWARE:**

Warranted to perform as required for five (5) years for residential use and one (1) year for commercial use from the date of purchase.

### **UMBRELLA, CUSHION, AND PILLOW FABRIC PRODUCTS:**

Fabric warranties vary by fabric type and are covered under a limited prorated warranty provided directly from the fabric mill. This warranty covers the fabric becoming un-serviceable because of loss of color or strength from normal exposure conditions including sunlight, mildew, rot, and atmospheric chemicals. Warranty does not cover ripped, torn, or frayed fabric or seams.

- Marine grade solution dyed acrylic fabrics are warranted against light fastness for a period of ten (10) years.
- Furniture grade solution dyed acrylic fabrics are warranted for a period of five (5) years.
- Sling grade solution dyed acrylic fabrics are warranted for a period of five (5) years.
- Ledge Lounger does not warranty provided Customer's Own Materials.

### **UMBRELLA POLES AND HARDWARE:**

Umbrellas are warranted for five (5) years for residential and commercial use, from the date of purchase, against defects in materials and workmanship.

For warranty to apply, all umbrellas must be secured in a properly weighted base.

Warranty does not cover the umbrella pole.

The customer is responsible for taking the umbrella down when winds reach unsafe conditions.

### **CABANA STRUCTURES:**

Cabana structures are warranted for two (2) years for residential and commercial use, from the date of purchase, against defects in workmanship.

For warranty to apply, all cabanas must be secured per instructions provided.

The customer is responsible for taking the fabrics off the cabana when winds reach unsafe conditions.

The following items are specifically excluded from the Ledge Lounger products limited warranty. Ledge Lounger shall not be liable for any failure, defect, or damage resulting from or connected with the following:

- Assembly, disassembly, or mishandling of products after they leave our facility, including any labor or installation by Ledge Lounger, a dealer, or an assembler.
- Any modifications made to the product after production including structural alterations or the application of any coating on a product not approved by Ledge Lounger (including paint, chemicals, varnish, etc.).
- Exposing Ledge Lounger products to heat from an external source (including grills, firepits, and reflections from windows and doors).Lounger)
- Ordinary wear and tear, abuse, or neglect, mishandling or otherwise abnormal use, including combined use of an incompatible product or accessory not manufactured by Ledge Lounger
- Lack of regular/suggested maintenance (please see cleaning/maintenance information for details on how to maintain Ledge Lounger products).



- Fading – Ledge Lounger products are made to be UV resistant to reduce fading, but when exposed to the sun, color will fade to a degree (to protect against fading: reduce direct sunlight by storing or covering the products).
- Deviances in color, pattern, or variations in products purchased at a later date or replacement parts, compared to originals.
- Rust or corrosion of stainless steel or zinc coated steel hardware including corrosion due to exposure to salt-water conditions.
- For in water use, improper balance of chemicals in water in which Ledge Lounger products are used.
- Damage caused by acts of God, air pollution or other environmental conditions, corrosive atmospheres, intentional acts, unreasonable use, vandalism, or civil disorder.

Warranty does not apply to:

- Transportation, labor, or assembly costs
- Incidental or consequential damages resulting from the use of products
- Any parties or individuals other than the original owner



**TIPS**

## การคำนวณหาปริมาณน้ำในสระ POOL VOLUME CALCULATION

$$\text{กว้าง} \times \text{ยาว} \times \text{ลึก (เมตร)} = \text{ปริมาณน้ำ (ลูกบาศก์เมตร)}$$

$$\text{Width} \times \text{Length} \times \text{Depth} = \text{Pool Volume}$$

**ตัวอย่างที่ 1** ความลึกเท่ากันทั้งสระ  
สระกว้าง 10 เมตร  
ยาว 20 เมตร  
ลึก 1.5 ม.

**สูตร** กว้าง x ยาว x ลึก  
=  $10 \times 20 \times 1.5$   
= 300 ลูกบาศก์เมตร

**Example 1** Pool width 10 m.  
Length 20 m.  
Depth 1.5 m

**Formula** Width x Length x Depth  
=  $10 \times 20 \times 1.5$   
=  $300 \text{ m}^3$

**ตัวอย่างที่ 2** ความลึกไม่เท่ากัน  
สระกว้าง 10 เมตร  
ยาว 20 เมตร  
ลึก 1.5 – 2 เมตร

**สูตร** กว้าง x ยาว x ลึก  
=  $10 \times 20 \times (1.5 + 2 \div 2)$   
= 350 ลูกบาศก์เมตร

**Example 2** Pool width 10 m.  
Length 20 m.  
Depth 1.5 - 2 m

**Formula** Width x Length x Depth  
=  $10 \times 20 \times (1.5 + 2 \div 2)$   
=  $350 \text{ m}^3$

หน่วย (Unit)	คิวบิกเมตร (m <sup>3</sup> )	ลิตร (liter)	มิลลิลิตร (ml)	ลบ.ซม. (cc)	แกลลอน Us. (US.Gallon)
1 ลบ.ม. (cu.m)	1	1,000	1,000,000	1,000,000	264

หน่วย (Unit)	คิวบิกเมตร (m <sup>3</sup> )	ลิตร (liter)	มิลลิลิตร (ml)	ลบ.ซม. (cc)	แกลลอน Us. (US.Gallon)
1 แกลลอน Us. (US.Gallon)	0.0038	3.7854	3785.41	3785.41	1



# สูตรคำนวณ TURN OVER ของระบบสระว่ายน้ำ

## FILTRATION SYSTEM TURN OVER CALCULATION

$$\text{ปริมาณน้ำ(ลูกบาศก์เมตร)} \div \text{Flowrate ป้อนน้ำ(ลูกบาศก์เมตรต่อชั่วโมง)}$$

$$\text{Pool Volume(m}^3\text{)} \div \text{Flowrate of pump(m}^3\text{/hr)}$$

มาตรฐานสากลในการเปิดระบบกรองน้ำต่อวัน

- สระบริการ : 4-6 ชั่วโมง / วัน
- สระบ้าน : 6-8 ชั่วโมง / วัน

อีกวิธีให้เอาปริมาตรน้ำในสระตั้งแล้วหารด้วยชั่วโมงการทำงาน แล้วเอาผลลัพธ์ที่ได้ไปหา Flow Rate ของปั๊มและเครื่องกรองในแผนภูมิของอุปกรณ์

### Standard Turn Over of Filtration System Per Day

- Commercial Pool : 4-6 Hours / day
- Residential Pool : 6-8 Hours / day

Another way to calculate this is by taking the Pool volume  $\div$  Hours per day, then use the number to find the matching flow rate of pump and filter

FILTER	
Pump	150 m <sup>3</sup>
"EMAUX" Sand filter MFS35 Flow rate	30.5 m <sup>3</sup> /hr
Turnover	4.92 hr
PUMP	
Pump	150 m <sup>3</sup>
"EMAUX" Pump SB20 2Hp / 220 / 1PH / 50Hz H.10 M Flow rate	28.2 m <sup>3</sup> /hr
Turnover	5.32 hr

# ตารางเทียบจับคู่เครื่องกรองและปั้มน้ำ

## TABLE MATCHING FILTERS AND PUMPS



VOLUME WATER	FILTRATION SYSTEM (FOR DIFFERENT TURNOVER) / HEAD AT 10 METERS				
	4 Hours	6 Hours	8 Hours	10 Hours	12 Hours
CU.M					
20	FSF 400 = 1 set	FSF 400 = 1 set	FSF 400 = 1 set	FSF 400 = 1 set	FSF 400 = 1 set
40	FSF 500 = 1 set	FSF 450 = 1 set			
60	FSF 650 = 1 set	FSF 500 = 1 set			
80	S700 + SB15 = 1 set	S650 + SB10	FSF 500 = 1 set	FSF 450 = 1 set	FSF 450 = 1 set
100	S900 + SB30 = 1 set		FSF 650 = 1 set	FSF 500 = 1 set	
120		S700 + SB15	S650 + SB10 = 1 set	FSF 650 = 1 set	FSF 500 = 1 set
140	S800 + SB20 = 2 sets	S900 + SB30	S800 + SB20 = 1 set	S700 + SB15 = 1 set	S650 + SB10 = 1 set
160					
180	S900 + SB30 = 2 sets	S800 + SB20 = 2 sets	S900 + SB30 = 1 set	S800 + SB20 = 1 set	S700 + SB15 = 1 set
200					
220					
240					S800 + SB20 = 1 set
260	S800 + SB20 = 3 sets		S700 + SB15 = 2 sets	S900 + SB30 = 1 set	S900 + SB30 = 1 set
280	S900 + SB30 = 3 sets	S900 + SB30 = 2 sets	S800 + SB20 = 2 sets		
300					



FSF SERIES



V SERIES



S SERIES



"EMAUX" SB SERIES

หมายเหตุ : การหาค่า TURN OVER ให้ยึด FLOW RATE ของปั้มน้ำเป็นหลัก

# ตารางเทียบจับคู่เครื่องกรองและปั้มน้ำ

## TABLE MATCHING FILTERS AND PUMPS



VOLUME WATER	FILTRATION SYSTEM (FOR DIFFERENT TURNOVER) / HEAD AT 10 METERS		
	4 Hours	6 Hours	8 Hours
CU.M			
20	-	-	-
40	MFV24 + SPH075	-	-
60	MFV27 + SPH100	MFV24 + SPH075	-
80	MFV31 + SPH200	MFV27 + SPH100	MFV24 + SPH075
100			MFV27 + SPH100
120	MFV35 + SPH300	MFV31 + SPH200	-
140	MFV27 + SPH100 = 2 sets		
160	MFV31 + SPH200 = 2 sets	MFV35 + SPH300	MFV31 + SPH200
180		MFV27 + SPH100 = 2 sets	
200	MFV35 + SPH300 = 2 sets	MFV31 + SPH200 = 2 sets	MFV35 + SPH300
220			
240	MFV31 + SPH200 = 3 sets	MFV31 + SPH200 = 2 sets	MFV27 + SPH100 = 2 sets
260			-
280	MFV31 + SPH200 = 3 sets	MFV31 + SPH200 = 2 sets	-
300	MFV35 + SPH300 = 3 sets		-



MFV SERIES



MFS SERIES



"EMAUX" SPH SERIES

หมายเหตุ : การหาค่า TURN OVER ให้ยึด FLOW RATE ของปั้มน้ำเป็นหลัก

# ตารางเทียบจับคู่เครื่องกรองและปั้มน้ำ

## TABLE MATCHING FILTERS AND PUMPS



Filter	Model No.	Filter Area (m <sup>2</sup> )	Valve connec. (inch/mm)	Max Flow gpm/m <sup>3</sup>	Sand (kg)	Filtration Velocity (m <sup>3</sup> /h/m <sup>2</sup> )	EMAUX Pump Model	Pipe Connec. (inch/mm)	HP	Vol	Max Flow (m <sup>3</sup> )	Max. Head (m)					
												6	8	10	12	14	16
MFV Series	MFV17	0.14	1.5 / 50	30.8 / 7	40	50	SC050	1.5 / 50	0.5	220	12	6.8	-	-	-	-	-
	MFV20	0.20	1.5 / 50	44 / 10	70	50	SC075	1.5 / 50	0.75	220	16	13.8	9	-	-	-	-
	MFV24	0.28	1.5 / 50	61.6 / 14	125	50	SC100	2.0 / 63	1	220	19	17	14	10	-	-	-
	MFV27A	0.36	1.5 / 50	63.36 / 14.4	185	50	SC150	2.0 / 63	1	220	20	20	17.2	14	-	-	-
	MFV27	0.36	2.0 / 63	79.2 / 18	185	50	SB10	2.5-3 / 75-90	1	220	19.5	16.4	14	11	7	-	-
	MFV31	0.47	2.0 / 63	103.4 / 23.5	320	50	SB20	4.0 / 110	2	220	28	-	28	25.2	22	18	12
	MFV35	0.61	2.0 / 63	134.2 / 30.5	430	50	SB30	4.0 / 110	3	380	29	-	-	28.4	26	23	19.2

Filter	Model No.	Filter Area (m <sup>2</sup> )	Valve connec. (inch/mm)	Max Flow gpm/m <sup>3</sup>	Sand (kg)	Filtration Velocity (m <sup>3</sup> /h/m <sup>2</sup> )	EMAUX Pump Model	Pipe Connec. (inch/mm)	HP	Vol	Max Flow (m <sup>3</sup> )	Max. Head (m)					
												6	8	10	12	14	16
MFS Series	MFS17	0.14	1.5 / 50	30.8 / 7	40	50	SC050	1.5 / 50	0.5	220	12	6.8	-	-	-	-	-
	MFS20	0.20	1.5 / 50	44 / 10	70	50	SC075	1.5 / 50	0.75	220	16	13.8	9	-	-	-	-
	MFS24	0.28	1.5 / 50	61.6 / 14	125	50	SC100	2.0 / 63	1	220	19	17	14	10	-	-	-
	MFS27A	0.36	1.5 / 50	63.36 / 14.4	185	50	SC150	2.0 / 63	1	220	20	20	17.2	14	-	-	-
	MFS27	0.36	2.0 / 63	79.2 / 18	185	50	SB10	2.5-3 / 75-90	1	220	19.5	16.4	14	11	7	-	-
	MFS31	0.47	2.0 / 63	103.4 / 23.5	320	50	SB20	4.0 / 110	2	220	28	-	28	25.2	22	18	12
	MFS35	0.61	2.0 / 63	134.2 / 30.5	430	50	SB30	4.0 / 110	3	380	29	-	-	28.4	26	23	19.2



MFV SERIES



MFS SERIES



"EMAUX" SC SERIES



"EMAUX" SB SERIES

หมายเหตุ : การหาค่า TURN OVER ให้ยึด FLOW RATE ของปั้มน้ำเป็นหลัก

# ตารางเทียบจับคู่เครื่องกรองและปั้มน้ำ

## TABLE MATCHING FILTERS AND PUMPS



Filter	Model No.	Filter Area (m <sup>2</sup> )	Valve connec. (inch/mm)	Max Flow gpm/m <sup>3</sup>	Sand (kg)	Filtration Velocity (m <sup>3</sup> /h/m <sup>2</sup> )	EMAUX Pump Model	Pipe Conne. (inch/mm)	HP	Vol	Max Flow (m <sup>3</sup> )	Max. Head (m)							
												6	8	10	12	14	16	18	
V Series	V350	0.09	1.5 / 50	19 / 4.32	20	50	SS050	1.5 / 50	0.5	220	10	4	-	-	-	-	-	-	
	V400	0.13	1.5 / 50	28.51 / 6.48	35	50	SS075	1.5 / 50	0.75	220	12.2	9.4	5	-	-	-	-	-	
	V450	0.16	1.5 / 50	35.64 / 8.10	45	50	SS100	1.5 / 50	1	220	15.2	11.4	8.4	4	-	-	-	-	
	V500	0.22	1.5 / 50	48.84 / 11.10	85	50	SC075	1.5 / 50	0.75	220	16	13.8	9	-	-	-	-	-	
	V650	0.32	1.5 / 50	68.64 / 15.60	145	50	SC150	1.5 / 50	1	220	20	20	17.2	14	-	-	-	-	
	V700	0.4	1.5 / 50	85.8 / 19.5	210	50	SC150	1.5 / 50	1	220	20	20	17.2	14	-	-	-	-	
	V700B	0.41	2.0 / 63	88.70 / 20.16	215	50	SB10	2.0 / 63	1	220	19.5	16.4	14	11	7	-	-	-	
	V800	0.5	2.0 / 63	109.56 / 24.90	355	50	SB15	2.0 / 63	1.5	220	24	24	22	19.5	16	12	3	-	
	V900	0.64	2.0 / 63	137.28 / 31.20	470	50	SB30	2.0 / 63	3	380	29	-	28.4	26	23	19.2	-	-	
	V1000	0.79	2.0 / 63	171.6 / 39	620	50	EPH400	2.5 / 75	4	380	47	44.5	40.8	39	36	32	28	-	
	V1000C	0.79	2.5 / 75	173.8 / 39.5	620	50	EPH400	2.5 / 75	4	380	47	44.5	40.8	39	36	32	28	-	
	V1200	1.03	2.0 / 63	227.0 / 51.60	860	50	SE5.5	3.0 / 90	5.5	380	70	-	65	55	42.5	25	-	-	
	V1200C	1.13	2.5 / 75	248.6 / 56.5	860	50	SE7.5	3.0 / 90	7.5	380	80	-	77.5	71	62.5	52.5	40	20	

Filter	Model No.	Filter Area (m <sup>2</sup> )	Valve connec. (inch/mm)	Max Flow gpm/m <sup>3</sup>	Sand (kg)	Filtration Velocity (m <sup>3</sup> /h/m <sup>2</sup> )	EMAUX Pump Model	Pipe Conne. (inch/mm)	HP	Vol	Max Flow (m <sup>3</sup> )	Max. Head (m)							
												6	8	10	12	14	16	18	
S Series	S450	0.16	1.5 / 50	35.64 / 8.10	45	50	SS100	1.5 / 50	1	220	15.2	11.4	8.4	4	-	-	-	-	
	S500	0.22	1.5 / 50	48.84 / 11.10	85	50	SC075	1.5 / 50	0.75	220	16	13.8	9	-	-	-	-		
	S650	0.32	1.5 / 50	68.64 / 15.6	145	50	SC150	1.5 / 50	1	220	20	20	17.2	14	-	-	-		
	S700	0.4	1.5 / 50	85.8 / 19.5	210	50	SC150	1.5 / 50	1	220	20	20	17.2	14	-	-	-		
	S700B	0.41	2.0 / 63	88.70 / 20.16	215	50	SB10	2.0 / 63	1	220	19.5	16.4	14	11	7	-	-		
	S800	0.53	2.0 / 63	106.0 / 24.10	355	50	SB15	2.0 / 63	1.5	220	24	24	22	19.5	16	12	3		
	S900	0.66	2.0 / 63	130.68 / 29.70	470	50	SB30	2.0 / 63	3	380	29	-	28.4	26	23	19.2	-		
	S1000	0.82	2.0 / 63	176.88 / 40.20	620	50	EPH400	2.5 / 75	4	380	47	44.5	40.8	39	36	32	28		
	S1000C	0.82	2.5/75	180.4 / 41.0	620	50	EPH400	2.5 / 75	4	380	47	44.5	40.8	39	36	32	28		
	S1200	1.13	2.0 / 63	232.32 / 52.8	860	50	SE5.5	3.0 / 90	5.5	380	70	-	65	55	42.5	25	-		
	S1200C	1.13	2.5 / 75	257.4 / 58.5	860	50	SE7.5	3.0 / 90	7.5	380	80	-	77.5	71	62.5	52.5	40		



V SERIES



S SERIES



"EMAUX" SB SERIES



"EMAUX" SC SERIES



"EMAUX" SS SERIES



"EMAUX" EPH SERIES



"EMAUX" SE SERIES

หมายเหตุ : การหาค่า TURN OVER ให้ยึด FLOW RATE ของปั้มน้ำเป็นหลัก

# ตารางเทียบจับคู่เครื่องกรองและปั้มน้ำ

## TABLE MATCHING FILTERS AND PUMPS



Filter	Model No.	Filter Area (m <sup>2</sup> )	Valve connec. (inch/mm)	Max Flow gpm/m <sup>3</sup>	Sand (kg)	ESPA Pump Model No.	Pipe Connec. (inch/mm)	HP	Vol/Hz	Max Flow (m <sup>3</sup> )	Max. Head (m)						
											6	8	10	12	14	18	20
SANDIA	SSR-16	0.135	1.5 / 50	28.6 / 6.5	50	GAMMA7	1.5 / 50	0.75	220 / 50	13.5	10	6	4	-	-	-	-
	SSR-18	0.166	1.5 / 50	37.4 / 8.5	75	GAMMA11	1.5 / 50	1	220 / 50	17	13.8	11	7.8	-	-	-	-
	SSR-24	0.300	1.5 / 50	63.8 / 14.5	125	GAMMA15	2.0 / 63	1.5	220 / 50	21	17	14	10.5	-	-	-	-
	SSR-30 SSC-30	0.460	2.0 / 63	99 / 22.5	200	GAMMA20	2.0 / 63	2	220 / 50	26.2	22.5	19.8	16.4	-	-	-	-
	SSC-36	0.660	2.0 / 63	136.4 / 31	375	RESORT30-40	2.5-3 / 75-90	2-3.0	220-380 / 50	45	42	37	32	25	15	-	-
	SSC-42	0.970	3.0 / 90	189.2 / 43	550	RESORT50-55	4.0 / 110	4.0-5.5	380 / 50	55	55	52-55	48-53	47-51	43-48	32-38	23-33
	SSC-48	1.13	3.0 / 90	246.4 / 56	850	RESORT80	4.0 / 110	5.5	380 / 50	95	92	89	81	72	55	-	-
	HZC-30	1.25	4.0 / 110	246.4 / 56	750	RESORT80	4.0 / 110	5.5	380 / 50	95	92	89	81	72	55	-	-
	HZC-36	1.50	4.0 / 110	294.8 / 67	950	RESORT 80-110	4.0 / 110	5.5-7.5	380 / 50	110	110	108	100	90	82	48	26
	HZC-42	2.0	4.0 / 110	396 / 90	1200	RESORT110	4.0 / 110	7.5	380 / 50	110	110	108	100	90	82	48	26
	HZC-48	2.5	6.0 / 150	497.2 / 113	1600	RESORT110	4.0 / 110	7.5	380 / 50	110	110	108	100	90	82	48	26
	DBF-18	0.166	1.5 / 50	31.68 / 7.2	300	GAMMA7	1.5 / 50	0.75	220 / 50	13.5	10	6	4	-	-	-	-
	DBF-24	0.30	2.0 / 63	59.4 / 13.5	575	GAMMA15	2.0 / 63	1.5	220 / 50	17	13.8	11	7.8	-	-	-	-
	DBF-30	0.45	2.0 / 63	88 / 20	1050	GAMMA20	2.0 / 63	2	220 / 50	26.2	22.5	19.8	16.4	-	-	-	-
	DBF-42	0.97	3.0 / 90	189.2 / 43	1825	RESORT 50-55	4.0 / 110	4.0-5.5	380 / 50	55	55	52-55	48-53	47-51	43-48	32-38	23-33



หมายเหตุ : การหาค่า TURN OVER ให้ยึด FLOW RATE ของปั้มเป็นหลัก

# ตารางเทียบจับคู่เครื่องกรองและปั้มน้ำ

## TABLE MATCHING FILTERS AND PUMPS

Filter	Model No.	Filter Area (m <sup>2</sup> )	Valve connec. (inch/mm)	Max Flow (gpm/m <sup>3</sup> )	EMAUX Pump Model	Max. Head TDH 10 m (m <sup>3</sup> /h)	Pool Volume (m <sup>3</sup> )	Turnover (hrs)
ICF Series Galaxy Single-Element	ICF100	9.29	2.0/63	22.7	SPH150	19	110	6
	ICF150	13.94	2.0/63	27.3	SB20	25	150	6
	ICF200	18.58	2.0/63	27.3	SB20	25	150	6
ICF Series Galaxy Multi-Element	ICF230	21.37	2.0/63	19.6	SPH150	19	110	6
	ICF330	30.73	2.0/63	28.1	SPH300	25	150	6
	ICF430	39.97	2.0/63	34.5	EPH300	32	190	6
	ICF530	49.19	2.0/63	34.5	EPH300	32	190	6
	ICF680	63.13	2.0/63	34.5	EPH300	32	190	6

Galaxy Filters		Filter Area (m <sup>2</sup> )	Max. Flow Rate (m <sup>3</sup> /h)	Suggested Pump		
Model Name	Model No.			at 10 (m) Head	at 8 (m) Head	at 6 (m) Head
Single-Element	ICF100	9.29	22.7	SPH200 (23 m <sup>3</sup> /h)	SPH200 (25.5 m <sup>3</sup> /h)	SPH150 (24 m <sup>3</sup> /h)
	ICF150	13.94	27.3	SB30 (28.4 m <sup>3</sup> /h)	SB20 (28 m <sup>3</sup> /h)	SPH200 (27.5 m <sup>3</sup> /h)
	ICF200	18.58	27.3	SB30 (28.4 m <sup>3</sup> /h)	SB20 (28 m <sup>3</sup> /h)	SPH200 (27.5 m <sup>3</sup> /h)
Multi-Element	ICF230	21.37	19.6	SPH150 (19.9 m <sup>3</sup> /h)	SPH150 (22 m <sup>3</sup> /h)	SPH150 (24 m <sup>3</sup> /h)
	ICF330	30.73	28.1	SB30 (28.4 m <sup>3</sup> /h)	SPH300 (28.5 m <sup>3</sup> /h)	SPH300 (30 m <sup>3</sup> /h)
	ICF430	39.97	34.5	EPH400 (39 m <sup>3</sup> /h)	EPH300 (35 m <sup>3</sup> /h)	EPH300 (37 m <sup>3</sup> /h)
	ICF530	49.19	34.5	EPH400 (39 m <sup>3</sup> /h)	EPH300 (35 m <sup>3</sup> /h)	EPH300 (37 m <sup>3</sup> /h)
	ICF680	63.13	34.5	EPH400 (39 m <sup>3</sup> /h)	EPH300 (35 m <sup>3</sup> /h)	EPH300 (37 m <sup>3</sup> /h)



ICF SERIES GALAXY SINGLE-ELEMENT



ICF SERIES GALAXY MULTI-ELEMENT



"EMAUX" SB SERIES



"EMAUX" SPH SERIES



"EMAUX" EPH SERIES

หมายเหตุ : การหาค่า TURN OVER ให้ยึด FLOW RATE ของปั้มน้ำเป็นหลัก

# มาตรฐานห้องเครื่องสระว่ายน้ำน้ำ

## STANDARD MACHINE ROOM FOR SWIMMING POOL EQUIPMENT



- ระดับของพื้นห้องเครื่องควรอยู่ที่ระดับต่ำกว่าผิวน้ำในสระพอสมควร
- ควรอยู่ใกล้สระให้มากที่สุด และควรอยู่ใกล้ด้านที่มีแท่งค้ำเก็บน้ำฝน หรือ สกิมเมอร์
- อากาศถ่ายเทได้สะดวก ไม่อับชื้น และแสงสว่างทั่วถึง
- ขนาดห้องเครื่องขึ้นอยู่กับปริมาณน้ำในสระและขนาดของระบบกรอง ที่สำคัญควรเผื่อพื้นที่สำหรับเจ้าหน้าที่ดูแลรักษาได้สะดวก เพื่อยืดอายุการใช้งานของอุปกรณ์
- สำหรับห้องเครื่องที่อยู่ใต้ดินต้องมีบ่อพักน้ำทิ้งและบ่อดูดน้ำทิ้งอัตโนมัติ พร้อมพัดลมระบายอากาศ

## วิธีการดูแลรักษาปั๊ม และมอเตอร์

### สาเหตุหลักๆ ที่มักจะทำให้ปั๊มน้ำเสีย



- การเปิดใช้เป็นระยะเวลานาน
- การใช้งานที่หนักเกินขีดจำกัดของปั๊ม
- มอเตอร์เกิดความร้อน จากสาเหตุน้ำในระบบมีน้อยเกินไป
- บ่อดูดอากาศเข้าไปในระบบ(สาเหตุอาจจะมาจากการเสื่อมของ ลูกยางหรือซีลต่างๆ และท่อมีการแตกหักหรือรั่ว)
- ปั๊มทำงานโดยไม่มีน้ำไหลผ่าน ไม่มีน้ำในระบบ หรือดูดน้ำไม่ขึ้น
- การระบายอากาศบริเวณที่ติดตั้งปั๊มไม่เพียงพอ
- บริเวณที่ติดตั้งปั๊มชื้นแฉะ
- ไฟกระชาก ไฟดับ ไฟช็อต ส่งผลให้แฉวงจรไฟของปั๊มน้ำเสียหายได้
- ตรวจเช็คระบบท่อรวมถึงวาล์วต่างๆ เป็นประจำหากพบ การแตก รั่ว หรือ ซีม ให้รีบแก้ไข หากปล่อยทิ้งไว้จะทำให้บ่อดูดเอาอากาศเข้าไปในระบบ ซึ่งเป็นสาเหตุทำให้ปั๊มน้ำเสีย
- ตรวจเช็คการรั่วซึมของซีลเพลลา แมคคานิคอลซีล ซึ่งป้องกันน้ำรั่วซึม ระหว่างใบพัดปั๊ม และเสื้อเพลลาใบพัด (หรือเปลี่ยนใหม่ ทุกๆ 1-2 ปี)
- ตรวจเช็คลูกปืนเพลลาหน้าหลัง โดยการฟังเสียง หากลูกปืนเพลลาเสียมมีเสียงดัง อาจทำให้รอบการหมุนของมอเตอร์ผิดปกติได้ (หรือเปลี่ยนใหม่ ทุก ๆ 2 ปี)
- ตรวจวัดกระแสแอมป์ของมอเตอร์ พร้อมปรับตั้งโอเวอร์โหลด (ถ้ามี) ซึ่งการใช้งานมอเตอร์นานๆ ชดลดมอเตอร์เสื่อมอายุ กระแสแอมป์ อาจเพิ่มได้
- ตรวจเช็คตะกั่วค้ำกษะหน้าปั๊ม Strainer ทำความสะอาดทุกครั้งเมื่อมีขยะ หากปล่อยไว้เป็นสาเหตุทำให้น้ำเข้าไม่เต็มปั๊ม
- ทำความสะอาดตัวปั๊มมอเตอร์ และใบพัดระบายความร้อนโดยการเช็ดและเป่าฝุ่น เพื่อเพิ่มประสิทธิภาพในการระบายความร้อนของตัวเรือนมอเตอร์
- ไม่ควรเปิดใช้งานปั๊มต่อเนื่องเป็นเวลานานโดยไม่พักเครื่อง
- หมั่นตรวจเช็คค่าน้ำในระบบอย่าให้ขาด
- ทำความสะอาดถังกรองเป็นประจำ อย่าเดินปั๊มหากถังกรองตัน



## ข้อชี้แนะการแก้ปัญหาเบื้องต้น

อาการ	ต้นเหตุ	สาเหตุการเกิดอาการ	ผล	วิธีแก้
ปั้มน้ำ	• ลมเข้า	• ท่อดูดวาล์วหน้าปั้มน้ำรั่ว • ไล่ลมที่ท่อดูดตะกอนไม่หมด	• ปั้มน้ำไม่ขึ้นทำงานไม่เต็มที่ • ท่อใกล้ตัวปั้มน้ำหลุดหรือหลวมใช้การไม่ได้	• แก่สาเหตุที่ลมเข้า • ล่อน้ำ เดินเครื่องใหม่ให้เรียบร้อย หากทำไม่สำเร็จให้ติดต่อช่างบริการด่วน
	• เศษผงติดใบพัด	• ไล่ตะกร้ากรองผงผิดตำแหน่ง • ตะกร้าขาด ไม่สามารถกรองผงได้ดี	• ปั้มสึกกร่อน • ใบพัดเสียงดัง • ใบพัดแตก	• ไล่ตะกร้าให้เข้าตำแหน่ง เปลี่ยนตะกร้าใหม่ • เปลี่ยนใบพัดปั้มน้ำใหม่
มอเตอร์คัง	• ลูกปืนแตก	• น้ำเข้าลูกปืน • ลูกปืนหมดอายุ จารบีแห้ง	• ส่งเสียงดัง ปั้มน้ำใหม่ • ปั้มน้ำทำงานผิดปกติบ่อยโดยไม่ทราบสาเหตุ	• เปลี่ยนลูกปืน • พอกและกลึงแกนมอเตอร์หรือกลึงแกนใหม่
ท่อน้ำ และ ท่อน้ำปั้มน้ำ	• ปั้มน้ำทำงานหนัก และไม่มีน้ำผ่านเพียงพอ	• อากาศเข้าปั้มน้ำได้ • ท่อด้านดูดตัน • เครื่องกรองตัน	• ทำให้มอเตอร์ร้อนทิ้งไว้ท่อน้ำหลวม • ท่อไหลกลับหลวม	• หาสาเหตุลมเข้า แก้ไขทันที • แก่อาการตันของท่อ • ล้างเครื่องกรองใหม่ • แจ้งช่างให้มาซ่อม
ท่อดูดตะกอนตัน	• ใช้ดูดผงขนาดใหญ่ • ลมเข้าเครื่อง • เครื่องกรองตัน	• ท่อดูดไม่มีแรงดูดเนื่องจากตัน • มีลมในตัวปั้มน้ำทำให้ไม่ดูด • น้ำส่งผ่านเครื่องกรองไม่ได้	• ดูดตะกอนไม่ได้	• ซักดั่งดูดตัน • ไล่ลมล่อน้ำใหม่ • ล้างเครื่องกรองให้สะอาด
กระบอกเซลล์เครื่องเกลือแตก	• ปิดวาล์วทางเข้าออกน้ำของกระบอกเซลล์ • Backwash ถังกรองโดยไม่ปิดสวิตช์เครื่องเกลือ	• เกิดแก๊สแรงดันภายในกระบอกเซลล์	• กระบอกเซลล์แตก	• เปลี่ยนกระบอกเซลล์ • เมื่อเวลา Backwash ถังกรอง ต้องปิดสวิตช์เครื่องเกลือทุกครั้ง โดยไม่ยุ่งกับระบบวาล์วของเครื่องเกลือ
เครื่องเกลือ "EMAUX" หน้าจอขึ้น 888	• พีวส์ทางด้าน Output ไปหาเซลล์ขาด	• ระดับความเค็มในน้ำต่ำหรือสูงเกินไปเป็นเวลานานมาตรฐานความเค็มอยู่ที่ 3200 – 4000 ppm	• เครื่องหยุดการทำงาน	• เปลี่ยนพีวส์ใหม่ • รักษาระดับความเค็มในน้ำให้ได้มาตรฐานที่ 3200 – 4000 ppm
ไฟสระไม่ติด	• หลอดขั้วหลวม • หลอดขาด • หม้อแปลงไหม้	• ขั้วหลวมเมื่อใช้นานๆ • น้ำไม่หมุนเวียน • สภาพพระบายอากาศในห้องเครื่องไม่ดี	• ไฟดับ	• ซักขั้วหลอดให้แน่น • เปลี่ยนหลอดใหม่ • เปลี่ยนหม้อแปลง
ต้องเติมน้ำในสระบ่อย	• ท่อรั่ว • สระรั่ว • ประตูน้ำรั่ว • ฟิล์มวาล์วเสียหาย	• บริเวณสระทรุดตัว • สระซึม • ประตูน้ำทั้ง ซ้ำรูด	• น้ำขุ่นหรือเขียวบ่อย เปลืองเคมีและค่าใช้จ่ายอื่นๆ	• เรียกช่างมาตรวจแก้ไขโดยด่วน • ยานแนวสระใหม่ทั้งสระ • เปลี่ยนประตูน้ำที่ซ้ำรูดเสียหาย • เปลี่ยนฟิล์มวาล์วที่ซ้ำรูดเสียหาย

## TROUBLESHOOTING

Problem	Root Cause	Bause of Abnormal Function	Outcome	Solution
Pump making loud noise	<ul style="list-style-type: none"> <li>Inflow of air in the pump</li> </ul>	<ul style="list-style-type: none"> <li>Leaking valve suction</li> <li>Failure to bleed out the gas from sediment suction pipe</li> </ul>	<ul style="list-style-type: none"> <li>Pump cannot suck water and does not perform the full function</li> <li>Pipe near the pump slips, loosens</li> </ul>	<ul style="list-style-type: none"> <li>Address the cause of air inflow</li> <li>Perform priming and restart the equipment. If the problem persists, contact the service technician immediately</li> </ul>
	<ul style="list-style-type: none"> <li>Dirt stuck on the impeller</li> </ul>	<ul style="list-style-type: none"> <li>Dirt filter basket placed at wrong position</li> <li>Ripped basket unable to filter dirt well</li> </ul>	<ul style="list-style-type: none"> <li>Pump degraded</li> <li>Impeller making loud noise</li> <li>Impeller broken</li> </ul>	<ul style="list-style-type: none"> <li>Put the basket in place</li> <li>Replace the basket</li> <li>Replace the impeller</li> </ul>
Motor making loud noise	<ul style="list-style-type: none"> <li>Ball bearings broken</li> </ul>	<ul style="list-style-type: none"> <li>Water enters ball bearing</li> <li>Expired ball bearings, dry grease</li> </ul>	<ul style="list-style-type: none"> <li>Alert sound of burning pump</li> <li>Pump malfunction without symptoms</li> </ul>	<ul style="list-style-type: none"> <li>Replace the ball bearings</li> <li>Daub and lathe the motor shaft or re-lathe the shaft</li> </ul>
Water pipe and the pipe before the pump	<ul style="list-style-type: none"> <li>Pump overload and insufficient water flow</li> </ul>	<ul style="list-style-type: none"> <li>Air enters the pump</li> <li>Suction pipe blocked</li> <li>Filter blocked</li> </ul>	<ul style="list-style-type: none"> <li>Heat the motor for a moment to loosen the pipe</li> <li>If the return pipe is loose</li> </ul>	<ul style="list-style-type: none"> <li>Find the cause of the air inflow and solve it</li> <li>Remove blockage of the pipe</li> <li>Clean the filter again</li> <li>Contact a service technician for repair</li> </ul>
Sediment suction pipe blocked	<ul style="list-style-type: none"> <li>Used for sucking large-sized dirt</li> <li>Air enters the unit</li> <li>Filter blocked</li> </ul>	<ul style="list-style-type: none"> <li>Suction pipe does not suck due to blockage</li> <li>Presence of air in the pump disables suction</li> <li>Water cannot be supplied through the filter</li> </ul>	<ul style="list-style-type: none"> <li>Unable to suck sediment</li> </ul>	<ul style="list-style-type: none"> <li>Remove blockage</li> <li>Remove the priming air</li> <li>Clean the filter</li> </ul>
Cell cylinder of the salt unit is broken	<ul style="list-style-type: none"> <li>The outlet valve of the cell cylinder is closed</li> <li>Backwash the filter tank without switching off the salt unit</li> </ul>	<ul style="list-style-type: none"> <li>Air pressure is present in the cell cylinder</li> </ul>	<ul style="list-style-type: none"> <li>Cell cylinder broken</li> </ul>	<ul style="list-style-type: none"> <li>Replace the cell cylinder</li> <li>Upon filter tank backwash, always switch off the salt chlorinator without dealing with the valve system of the salt chlorinator</li> </ul>
Pool lights not on	<ul style="list-style-type: none"> <li>Loose connection of the bulb cap</li> <li>Light bulbs blown</li> <li>Transformer burnt</li> </ul>	<ul style="list-style-type: none"> <li>Loose connection of the bulb cap is possible after using for a long time.</li> <li>No water circulation</li> <li>Poor ventilation in the chamber</li> </ul>	<ul style="list-style-type: none"> <li>Power outage</li> </ul>	<ul style="list-style-type: none"> <li>Screw the bulb cap tightly</li> <li>Replace with a new bulb</li> <li>Replace with a new generator</li> </ul>
Need to refill the water too often	<ul style="list-style-type: none"> <li>Pipe leaking</li> <li>Pool leaking</li> <li>Valve leaking</li> <li>Foot valve damaged</li> </ul>	<ul style="list-style-type: none"> <li>Subsidence of the ground around the pool</li> <li>Pool leaking</li> <li>Effluent outlet damaged</li> </ul>	<ul style="list-style-type: none"> <li>The water becomes turbid or greens regularly, resulting in a waste of chemicals and other expenses</li> </ul>	<ul style="list-style-type: none"> <li>Contact a service technician to repair immediately</li> <li>Reseal the entire pool</li> <li>Replace the damaged valve</li> </ul>

## ข้อชี้แนะการแก้ปัญหาเบื้องต้น เครื่องกรองทราย

ปัญหา	สาเหตุ	การแก้ไข
น้ำในสระไม่ใสหรือไม่สะอาด	<ol style="list-style-type: none"> <li>การล้างย้อนทิศทางบ่อยครั้งเกินไป</li> <li>ระยะพ่นน้ำไม่เพียงพอหรือมีการใช้ทรายที่ไม่เหมาะสม</li> <li>อัตราการหมุนเวียนไม่เพียงพอเมื่อเทียบกับจำนวนผู้ใช้งานทั้งหมด</li> <li>มีสาหร่าย</li> </ol>	<ol style="list-style-type: none"> <li>การล้างย้อนทิศทางตามแรงดัน ไม่ใช่ตามเวลา ปฏิบัติตามคำแนะนำจากผู้ผลิตสำหรับแรงดันส่วนต่างที่เหมาะสม (โดยปกติ 7 -10 psi สูงกว่าแรงดันเริ่มต้น)</li> <li>ตรวจสอบระยะพ่นน้ำและความลึกของทราย ตรวจสอบข้อมูลจำเพาะของทรายให้แน่ใจ</li> <li>ตรวจสอบเครื่องวัดการไหลและตรวจสอบว่ามีข้อจำกัดเรื่องลมหรือไม่ หากจำเป็นควรจำกัดจำนวนผู้ใช้สระว่ายน้ำ</li> <li>รักษาระดับสารเคมีในสระให้เหมาะสม และกำจัดสาหร่ายตามความจำเป็น ทดสอบน้ำเพื่อหาค่าคลอรีนรวมและคลอรีนอิสระ</li> </ol>
วงจรรองน้ำสั้น	<ol style="list-style-type: none"> <li>ขั้นตอนการล้างย้อนทิศทางไม่เหมาะสม</li> <li>ชั้นทรายมีการอุดตัน</li> <li>มีสาหร่าย</li> <li>อัตราการไหลเกินอัตราสำหรับตัวกรอง (FMR)</li> <li>สารเคมีในสระว่ายน้ำถูกปล่อยเข้าไปในระบบไหลเวียนก่อนถึงตัวกรอง</li> </ol>	<ol style="list-style-type: none"> <li>ปฏิบัติตามคำแนะนำจากผู้ผลิต ให้ดูกระจกมองระดับและล้างย้อนทิศทางจนกว่าน้ำที่จะใส</li> <li>เอาทรายชั้นบนออกประมาณ 1-2 นิ้วแล้วเปลี่ยนทรายใหม่ เทสารทำความสะอาดทรายตามท้องตลาดให้ทรายเปียกแล้วใช้น้ำล้างออก</li> <li>รักษาระดับสารเคมีในสระให้เหมาะสมและกำจัดสาหร่ายตามความจำเป็น ทดสอบน้ำเพื่อหาค่าคลอรีนรวมและคลอรีนอิสระ</li> <li>ใช้เครื่องวัดการไหลเพื่อจัดการและจำกัดการไหลผ่านตัวกรองของน้ำ</li> <li>ย้ายท่อเข้าสารเคมีเพื่อส่งสารเคมีเข้าไปยังอุปกรณ์อื่น ๆ ทั้งหมด รวมถึงตัวกรองและเครื่องทำความร้อน</li> </ol>
ตัวกรองมีแรงดันสูง	<ol style="list-style-type: none"> <li>การล้างย้อนทิศทางไม่เพียงพอ</li> <li>ทรายกรองมีแร่ธาตุอุดตัน</li> <li>ท่อไหลกลับอุดตันหรือวาล์วถูกปิดบางส่วน</li> </ol>	<ol style="list-style-type: none"> <li>ปฏิบัติตามคำแนะนำจากผู้ผลิต ให้ดูกระจกมองระดับและล้างย้อนทิศทางจนกว่าน้ำที่จะใส</li> <li>เทสารทำความสะอาดทรายตามท้องตลาดให้ทรายเปียกแล้วใช้น้ำล้างออก</li> <li>นำสิ่งอุดตันที่ออกหรือเปิดวาล์ว</li> </ol>
มีทรายในสระ	<ol style="list-style-type: none"> <li>ท่อด้านข้างสำหรับระบายน้ำแตก</li> </ol>	<ol style="list-style-type: none"> <li>เปลี่ยนท่อใหม่ ตรวจสอบทรายเพื่อดูว่าแรงดันตัวกรองสูงทำให้ท่อด้านข้างชำรุดหรือไม่</li> </ol>
มีทรายในน้ำทิ้ง	<ol style="list-style-type: none"> <li>เครื่องจ่ายไฟหรือตัวกรองลมคักน้ำเสียหาย</li> <li>อัตราการล้างย้อนทิศทางมากเกินไป</li> <li>ขนาดของทรายไม่เหมาะสม</li> </ol>	<ol style="list-style-type: none"> <li>เปลี่ยนชิ้นส่วนที่เสียหาย</li> <li>ลดอัตราการล้างย้อนทิศทาง</li> <li>เปลี่ยนทรายใหม่ที่มีคุณสมบัติตามที่ผู้ผลิตตัวกรองกำหนดไว้</li> </ol>
อัตราการไหลไปยังสระต่ำกว่าขั้นต่ำและแรงดันน้ำไหลเข้าต่ำ	<ol style="list-style-type: none"> <li>ท่ออุดตันไปยังบ่อมีการอุดตัน</li> <li>ใบพัดเสียหายหรือชำรุด</li> </ol>	<ol style="list-style-type: none"> <li>ตรวจหาเส้นผมในตะกั่ว ตรวจสอบตัวกรองโซลันเปิดวาล์วที่ท่ออุดตัน</li> <li>ถอดชิ้นส่วนบ่อออกแล้วนำมาซ่อม</li> </ol>

**คำเตือน**

ตัวกรองระบบแรงดันทำงานภายใต้สภาวะแรงดันสูง ให้เปิดวาล์วระบายอากาศไว้เสมอและปิดบีมก่อนเปลี่ยนตำแหน่งหรือถอดวาล์ว ข้อรัด และอุปกรณ์เชื่อมต่อ หากไม่ปฏิบัติตามขั้นตอนที่เหมาะสมอาจทำให้อุปกรณ์แยกชิ้นส่วนอย่างรุนแรง ทำให้เกิดการบาดเจ็บร้ายแรงหรือทำให้เสียชีวิตได้

## TROUBLESHOOTING SAND FILTERS

Problem	Cause	Solution
<b>POOL WATER IS NOT CLEAR OR CLEAN</b>	<ol style="list-style-type: none"> <li>1. Too frequent of a backwash cycle.</li> <li>2. Freeboard not sufficient or improper sand was used for replacement purposes.</li> <li>3. Insufficient turnover rate as compared to total user load.</li> <li>4. Algae growth.</li> </ol>	<ol style="list-style-type: none"> <li>1. Backwash according to pressure and not time. See manufacturer's I/O instruction for proper pressure differential (usually 7 to 10 psi above starting pressure).</li> <li>2. Check freeboard and sand depth. Make sure of sand specifications.</li> <li>3. Check flow meter and determine if there are any hydraulic restrictions. Limit user load if necessary.</li> <li>4. Maintain proper pool chemistry and treat algae as necessary. Test water for total and free chlorine.</li> </ol>
<b>SHORT FILTER CYCLE</b>	<ol style="list-style-type: none"> <li>1. Improper backwash procedures.</li> <li>2. Sand bed blocked.</li> <li>3. Algae growth.</li> <li>4. High flow rate exceeds Filter Media Rate (FMR).</li> <li>5. Pool chemicals being fed into recirculation prior to the filter.</li> </ol>	<ol style="list-style-type: none"> <li>1. Follow manufacturer's I/O instructions. Watch sight gauge and backwash until effluent is clear.</li> <li>2. Remove the top 1 or 2 inches of sand and replace with new sand. Chemically soak sand bed with commercial sand cleaner and flush with water.</li> <li>3. Maintain proper pool chemistry and treat algae as necessary. Test water for total and free chlorine.</li> <li>4. Use flow meter to manage and restrict water flow through filter.</li> <li>5. Relocate chemical input lines to feed after all equipment, including filters and heaters.</li> </ol>
<b>HIGH FILTER PRESSURE</b>	<ol style="list-style-type: none"> <li>1. Insufficient backwashing.</li> <li>2. Sand bed blocked with mineral deposits.</li> <li>3. Blocked return line or partially closed valve.</li> </ol>	<ol style="list-style-type: none"> <li>1. Follow manufacturer's I/O instructions. Watch sight gauge and backwash until effluent is clear.</li> <li>2. Chemically soak sand bed with commercial sand cleaner, flush to waste.</li> <li>3. Remove line obstruction or open valve.</li> </ol>
<b>SAND IN POOL</b>	<ol style="list-style-type: none"> <li>1. Broken under-drain lateral.</li> </ol>	<ol style="list-style-type: none"> <li>1. Replace damaged laterals. Examine sand to determine if high filter pressure caused damage to laterals.</li> </ol>
<b>SAND IN WASTE WATER</b>	<ol style="list-style-type: none"> <li>1. Damaged distributor or air stainer.</li> <li>2. Backwash rate too high.</li> <li>3. Improper size sand.</li> </ol>	<ol style="list-style-type: none"> <li>1. Replace damaged items.</li> <li>2. Reduce backwash flow rate.</li> <li>3. Replace sand with new sand having the specifications required by the filter manufacturer.</li> </ol>
<b>FLOW RATE TO POOL BELOW MINIMUM REQUIRED AND LOW INFLUENT PRESSURE</b>	<ol style="list-style-type: none"> <li>1. Blockage in suction line to the pump.</li> <li>2. Impeller damaged or broken.</li> </ol>	<ol style="list-style-type: none"> <li>1. Check the hair in lint basket. Check the skimmer strainer. Open valves on the suction line.</li> <li>2. Disassemble the pump and repair.</li> </ol>

**WARNING**

Pressure filters operate under high pressure. Always open all air bleed valves and turn off the pump before changing valve options or removing and clamps or fittings. Failure to follow proper procedures could result in violent separation of the equipment, causing possible serious injury or death.

ข้อชี้แนะการแก้ปัญหาเบื้องต้น  
การบำรุงรักษาน้ำในสระว่ายน้ำ

ปัญหา / อาการ	สาเหตุ	การแก้ไข
<p>A. สีเขียวขุ่น</p> <p>B. จุดดำบนผนังสระว่ายน้ำ</p> <p>C. สีเขียวใส</p>	<p>A. สาหร่ายสีเหลืองสีน้ำตาลหรือสีเขียว</p> <p>B. สาหร่ายสีดำ</p> <p>C. ทองแดงหรือเหล็กในน้ำ</p>	<p>A. ใช้ Swimtrine &amp; Cleartrine</p> <p>B. ใช้ Black Algaetrine</p> <p>C. ปรับระดับค่า pH ให้อยู่ในช่วง 7.2 - 7.6 และเติม Cleartrine</p>
ไม่มีค่าคลอรีนในน้ำหรือมีน้อย	สภาพอากาศที่ร้อนแรง ปริมาณคนลงสระเป็นจำนวนมาก มีสิ่งสกปรกอยู่ในสระว่ายน้ำ ในปริมาณมาก	<ul style="list-style-type: none"> <li>เพิ่มปริมาณคลอรีนเพื่อรักษาระดับ</li> <li>คลอรีนตกค้างเป็น 1.00-3.00 ppm</li> <li>เพิ่มตัวปรับความเสถียรให้มีค่า 50 ppm</li> </ul>
<p>สีน้ำตาลติดบนพื้นผิวสระว่ายน้ำ</p> <ul style="list-style-type: none"> <li>REDDISH-BROWN หรือ YELLOW BROWN</li> <li>คราบบนพลาสติก</li> </ul>	<p>A. เหล็กในน้ำ</p> <p>B. ค่า pH สูง หรือค่าความเป็นด่างสูง</p>	ปรับ pH 7.2-7.6 และเติม Staintrine
น้ำเปลี่ยนสีเขียวมรกต	ระดับ pH ในน้ำสูงเกินไป และคลอรีนน้อย	ปรับค่า pH เป็น 7.2-7.6 เพิ่มคลอรีน และเติม Pooltrine

**SWIMTRINE**

**CLEARTRINE**

**BLACK ALGAETRINE**

**STAINTRINE**

**POOLTRINE**

## การเติมเกลือในสระว่ายน้ำ



การเติมในครั้งแรกให้เติมหลังจากปรับสภาพน้ำให้ใสและได้ค่า pH เป็นกลางแล้ว

สมมุติว่าน้ำในสระว่ายน้ำ 150 ลูกบาศก์เมตร ต้องใส่เกลือที่สระว่ายน้ำ 4 กิโลกรัม ต่อ น้ำ 1 ลูกบาศก์เมตร ดังนั้น มีน้ำในสระว่ายน้ำ 150 ลูกบาศก์เมตร ต้องใส่เกลือลงสระ  $150 \times 4 = \underline{600}$  กิโลกรัม



หรือ

เกลือ 1 ถุงหนัก 25 กิโลกรัม  
ดังนั้น ต้องใส่เกลือในสระว่ายน้ำ  $600 \div 25 = \underline{24}$  ถุง  
และทิ้งไว้ให้เกลือละลาย 24 ชั่วโมง

## การบำรุงรักษาเครื่องเกลือ



1. รักษาค่าเกลือในสระว่ายน้ำที่ 3500-4000 ppm

2. รักษาค่าเคมีในน้ำให้สมดุลคือ

- ค่า pH 7.2 - 7.6
- ค่า ALKALINTY 80 - 100 ppm
- ค่า HARDNESS 200 - 400 ppm

3. ทำความสะอาดเซลล์เครื่องเกลือ เมื่อพบเห็นตะกรันสีขาว

เกาะอยู่ที่แผ่นเซลล์ ด้วยส่วนผสมของ

**น้ำ 6 ส่วน : กรดเกลือ 1 ส่วน**

แช่จนกว่าคราบตะกอนจะหลุดออกหมดแล้วล้างด้วยน้ำสะอาด

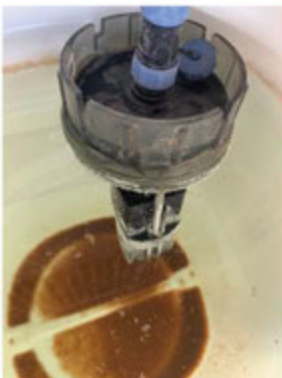

4. ใช้เครื่อง Salt Chlorinator รุ่นที่ม้การทำงานแบบสลับขั้วทำงานได้ (Reverse polarity) เพื่อลดการเกิดตะกรันเกาะแผ่นเซลล์



**CONTACTS**

## Head office

12/127 Moo.3 Wichit District,  
Chawfah West Road,  
Muang, Phuket 83000  
Thailand.

Tel: 095-285-55-33  
Email: [asiapoolcare@gmail.com](mailto:asiapoolcare@gmail.com)

## สำนักงานใหญ่

12/127 หมู่ 3 ถนน เจ้าฟ้าตะวันตก  
ต.ตำบลวิชิต อ.เมือง  
จังหวัดภูเก็ต 83000 ประเทศไทย

โทร 095-285-55-33  
อีเมลล์ [asiapoolcare@gmail.com](mailto:asiapoolcare@gmail.com)



 [poolcarethailand](https://www.facebook.com/poolcarethailand)

 [poolcarethailand](https://line.me/tv/poolcarethailand)